

Through Panel Fuseholder

778-ANLTP Through Panel ANL Fuseholder 35-500A

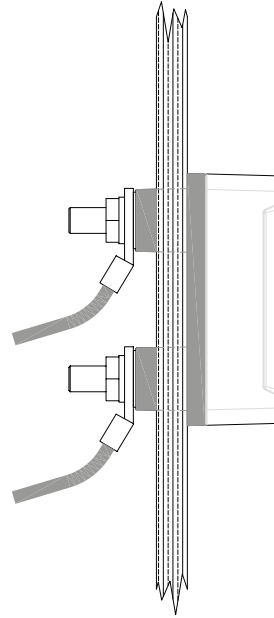

Modular

1.5x

778-ANLTP
-1.0x

0.5x

Footprint

This innovative, through-panel mounting fuseholder (Patent Pending) offers the user easy visual inspection of fuse state, and easy/safe access to change fuses if blown. It provides high-capacity fusing, fast response, high interrupt ratings (up to 3,000 Amps DC), and is ideal for protecting today's demanding onboard power electronics technology including inverters and battery chargers. It can also protect wiring from short circuits, for example as a main fuse to protect house circuits, protection for digital switching main feed circuits, or heavy duty loads.

Features & Benefits:

- Convenient fuse inspection and replacement
- Compact footprint saves space
- Radiused connection points improve cable routing options (back-to-back lugs fit at any angle -90° to +90°)
- Innovative clear cover provides insulation/protection
- Fuse viewing "window" in cover aids visual inspection of fuse-state.
- Label recess on cover allows fitting up to 1/2" width (12.7mm) printed labels from handheld label printers
- Insert moulded studs offer superior mechanical strength
- Designed for the harsh marine environment
- Studs have anti-seize lubrication applied to prevent thread galling

Specifications:

- Cable connection studs: 10mm (3/8")
- Fuse mounting studs: 8mm (5/16"). Also allows 10mm (3/8") fuses to be used
- Fuse type: ANL or ANN (very fast acting)
- Amperage: 35-500A
- 50 VDC, or determined by fuse fitted (if lower)
- High temperature, fibre reinforced plastic base provides strength and chemical resistance
- Clear polycarbonate cover
- Tinned CDA260 highly conductive brass for improved strength on integral studs, stainless steel nuts and washers for longevity in the marine environment
- All threads are metric

IMPORTANT! Read before installing

- Use only "plastic safe" corrosion inhibiting sprays. Do not wipe solvents/petrochemicals onto the clear polycarbonate covers. These chemicals can affect the plastic, resulting in deteriorated properties such as opacity, and brittleness
- Ensure all cables are sized correctly for the loads they carry. Please refer to the BEP website (www.bepmarine.com) to calculate correct cable sizes
- Ensure electrical connections are correctly tightened! Loose, high power connections are capable of damaging equipment or starting fires. See torque figures on facing page, alternatively use a ring spanner of the correct size and tighten until firm

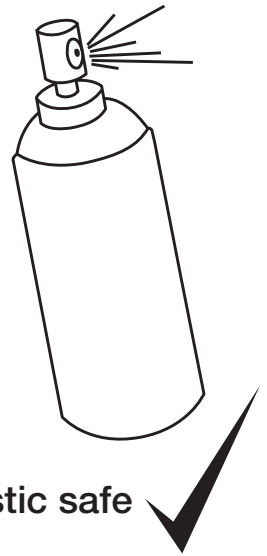

Plastic safe ✓

Petroleum based solvents ✗



Note: Maximum bulkhead penetration is 19mm (3/4") while still providing cable clearance

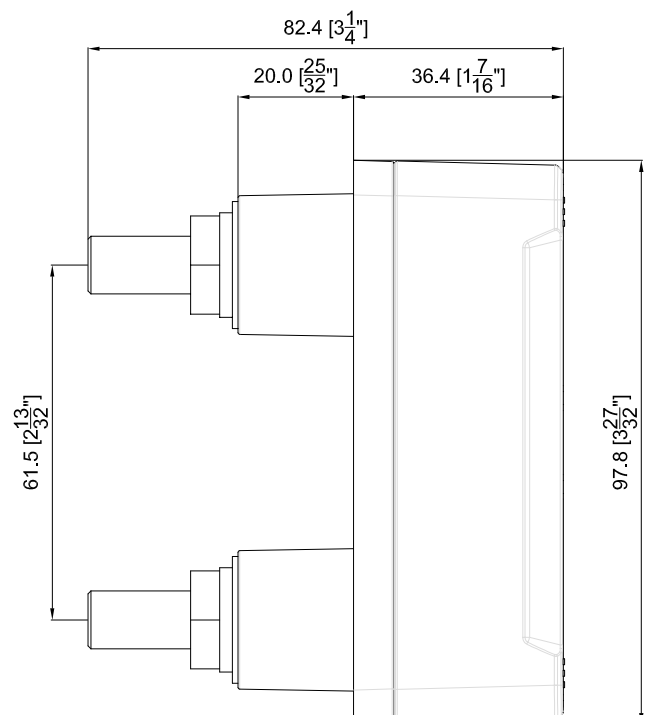

Installation Instructions:

1. Choose mounting location in dry, interior location
2. Select screws for mounting, 5mm (3/16"). Use only pan head or similar style screws
3. Use mounting template provided to mark out footprint and mount hole centres
4. Use a 1" (25mm) holesaw to cut the two mounting holes through the bulkhead, and the pilot holes for screws
5. Check the fuseholder's fit, in case the holes need adjusting for clearance
6. If a water tight seal is required through the bulkhead, add sealant when screwing the fuseholder into place
7. Screw the fuseholder into the chosen location
8. Fit fuse and cables
9. Plain washers **must** be used on top of 10mm fuses
10. Ensure that spring washers are in place beneath cable retaining nuts
11. Recommended torques:
 - 8mm (5/16") studs: 9 Nm (6.6 lbf).
 - 10mm (3/8") studs: 15 Nm (11.1 lbf).
12. Fit cover
13. Ensure that cables are securely fastened and strain relieved as per ABYC/ISO or other applicable standards

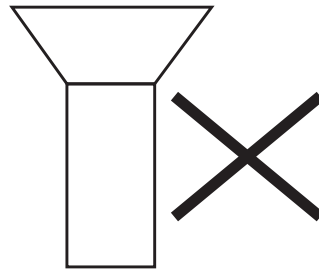

5mm (3/16")

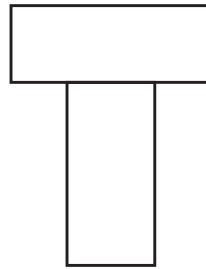

Panhead
Cheesehead
Sockethead

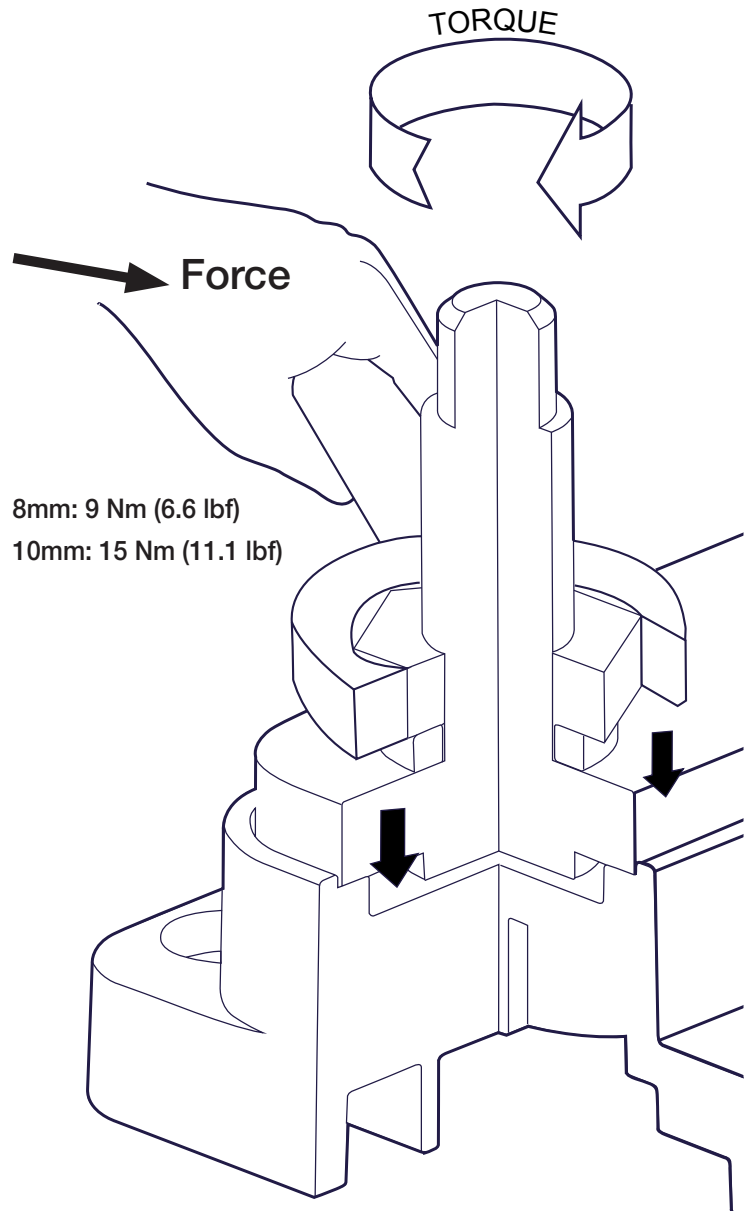

Mounting Template:

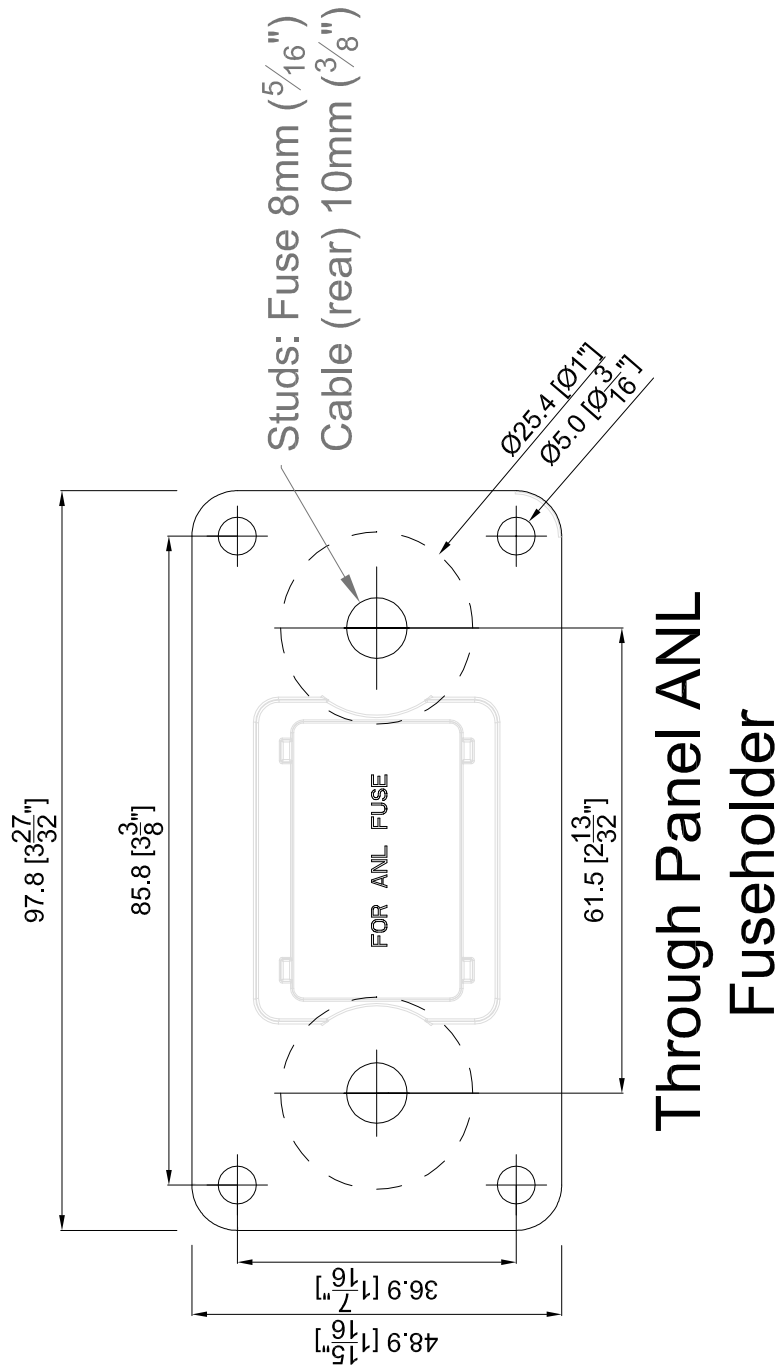

Product	Dimensions (mm)	Dimensions (Inches)	Weight (Grams)	Weight (oz)
ANL-TP	98 x 49 x 36 mm	3.9" x 1.9" x 1.4"	298g	10.5 oz