



Maritime

Thermal Night Vision Systems



See at Night.

Nighttime on the Water is Safer with FLIR®

Boating gives you the sense of freedom and independence you can't find anywhere else. Don't let darkness limit your pursuit of adventure and escape from everyday stresses.

FLIR thermal night vision technology is available to keep you safe all day, every day. Professional mariners and militaries around the world have been utilizing FLIR thermal night vision for years. Now that same technology is accessible to every boater, from the palm of your hand to the dashboard in your wheelhouse:

- **First Mate II:** Affordable, handheld thermal imaging for every boater, now featuring the InstAlert™ detection palette
- **MD-Series:** Affordable, fixed mounted cameras, ideal for collision avoidance and vessel security
- **M-Series:** FLIR's family of premier pan and tilt, single and multi-sensor cameras are ideal for collision avoidance and situational awareness on the water
- **Voyager:** 2 thermal imagers, 1 low-light color camera and full gyro-stabilization

Whether you enjoy fishing, cruising, sailing, or just exploring your world, all boaters have the same basic goals in mind: Enjoy the ride and bring everyone home safe.

Why Thermal is Better

Thermal imaging cameras detect and display tiny differences in heat, not light. So no matter how much light is available—from pitch black to moonlight to severe midday glare—thermal imagers display clear infrared video. The “detectors”—the key to FLIR technology for decades—pick up the thermal energy emitted by everything, even ice! FLIR cameras then convert that data into the crisp infrared video you see on the display.

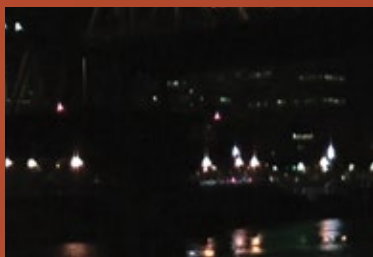

Your Vision



FLIR Vision



First Mate II



MD-Series



M-Series



Voyager Series

Stay Safe.

How FLIR Helps you Stay Safe

Collision Avoidance - Crystal-clear video helps you see natural and man-made hazards such as buoys, floating debris, rocks, land, bridge abutments, and other vessels night and day.

Finding People In The Water - Thermal night vision helps you to find a person in the water faster than any other night vision technology.

Easy To Use - FLIR cameras and video are intuitive and easy to use. Quite simply, what you see is what you get.

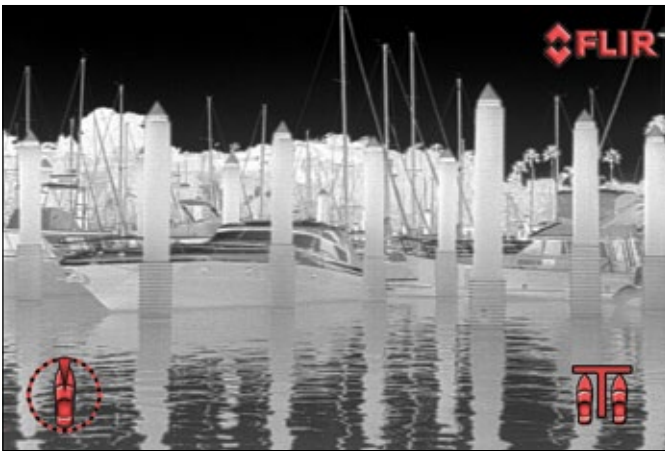

Dock safely

640 x 480

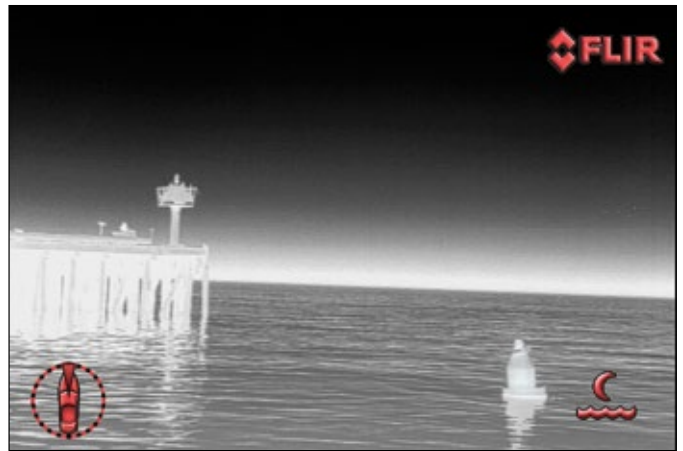

Identify buoys and other obstacles in the water

320 x 240



Find crew overboard faster

320 x 240



Locate other vessels

320 x 240

See at Night.

A Camera for Every Vessel

All FLIR thermal night vision cameras let you see clearly in total darkness, but you can also get color or lowlight cameras, gyro stabilization, radar interfacing and other helpful features. Which FLIR is right for you?

- How far do you need to see?
- Are you going to integrate with your other on-board systems?
- Do you want to be able to take it off of your boat?

First Mate II & First Mate II MS

- Handheld, lightweight
- Complements other thermal cameras
- Use it anywhere: Docking assistance, vessel inspection, search and rescue, situational awareness, off boat



Thermal Range Performance[†]

MS-224 & HM-224 Pro (24° Lens)

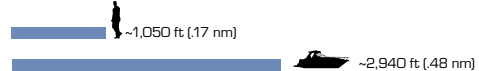

MS-324, & HM-324 XP+ (24° Lens)



HM-324 XP+ with 2x Extender^{††} (12° Lens)



HM-307XP (7° Lens)



MD-Series

- Affordable, fixed mount thermal imager
- Easy install and use
- Standard & High resolution thermal camera options
- Ethernet-enabled



Thermal Range Performance[†]

MD-324[†]



MD-625[†]



Stay Safe.



M-Series

- Premium Pan/Tilt thermal imager
- Thermal only or thermal/lowlight multi-sensor configurations
- Standard- and high-resolution thermal camera options
- Network-ready
- Auto-scan feature
- Easy to use joystick control

Thermal Range Performance[†]

M-324L & M-324XP

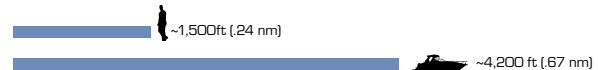

M-625L & M-625XP



M-618CS



Voyager Series

- Long-range
- Gyro-stabilized Pan/Tilt platform
- 2 thermal cameras
- Daylight/lowlight color camera
- Network-ready
- NMEA interfaces
- Radar slew-to-cue
- Video Tracker
- IP Addressability
- Temperature indication



Thermal Range Performance[†]

Voyager III



[†] = Actual object detection range performance may vary depending on camera set-up, environmental conditions, user experience, and type of display used.

^{††} - 2x Extender pertains to HM-Series only

All specifications are subject to change without notice. Visit www.flir.com for the most up-to-date specifications.

See at Night.

First Mate II MS-Series



First Mate II MS-Series Control Panel

Display:
Brightness Adjustment

Polarity:
Toggle Between Palettes:

- White hot
- Black hot
- InstAlert



Power

USB Port

Zoom/Freeze Frame*

* These features available on specific camera configurations

Ultra-compact and loaded with features, First Mate II MS-Series literally fits in the palm of your hand. Keep one in your pocket or in an easy-to-reach spot on your yacht, powerboat, fishing boat, sailboat, or anything else from an ocean liner to a dinghy. MS-Series is effective as your only thermal imaging device or as a complement to your mounted thermal imaging system because you can take it anywhere on the boat and everywhere off of it.

Learn more at www.FLIR.com/MS-Series.

Go-Anywhere Thermal Night Vision

First Mate II isn't mounted permanently on your boat, so you can use it to see at night everywhere!



Portable thermal systems go anywhere



Observe Wildlife: Great for Camping & Hiking



NEW: InstAlert™

Stay Safe.

Key Features:

- **InstAlert detection:** By adding a red highlight to the hottest elements in a scene, day or night, the First Mate II will help you locate a man-overboard faster than any other technology available.
- **Easy to use:** One-handed, push-button functionality means you can steer or point with one hand while zooming or switching palettes on your MS-Series with the other.
- **Compact & dependable:** Only 12 ounces. Less than 7 inches long. IP-67 rated, submersible to 1 meter. You'll rely on it often, night and day.



Thermal Imaging Specifications	MS-224	MS-324
Detector Type	240 x 180 VOx Microbolometer	320 x 240 VOx Microbolometer
FOV	24° x 18°	
Focal Length	19 mm	
Waveband	7.5 - 13.5 μm	
Start-up Time	< 5 seconds	
Focus	Fixed	
Image Processing	FLIR Proprietary Digital Detail Enhancement	
User Interface		
Power Button	On/Off	
Picture Button	N/A	N/A
Zoom Button	Freeze Frame	2x E-Zoom
Polarity	Toggles White Hot, Black Hot, InstAlert	
Brightness	Adjusts Display Brightness	
Image Presentation		
Built-In Display	Color LCD Display	
Video Output	N/A	N/A
Video Refresh Rate	<9 Hz	
Image Polarity	White Hot; Black Hot; InstAlert	
Power		
Battery Type	Internal Camera Battery / Li-Ion	
Battery Life (Operating)	5 Hours + (typical)	
Battery Life (Stand-By)	N/A	
Environmental		
Rating	IP-67 - Submersible to 1 meter	
Operating Temp.	-4°F to 122°F (-20°C to 50°C)	
Physical		
Weight (incl. lens)	12 oz (340 g)	
Size (L x W x H)	6.70" x 2.31" x 2.44" (172 x 58.7 x 62 mm)	
Packages Include	First Mate MS Handheld Maritime Thermal Night Vision Camera, Wrist Strap, Product CD, Drawstring Pouch	
Thermal Range performance†		
Detect Man (1.8 m x 0.5 m)	~1,050 ft (0.17 nm)	~1,450 ft (0.24 nm)
Detect Small Vessel (2.3 m x 2.3 m)	~2,940 ft (0.48 nm)	~4,100 ft (0.67 nm)
Warranty	3 Year (with product registration)	

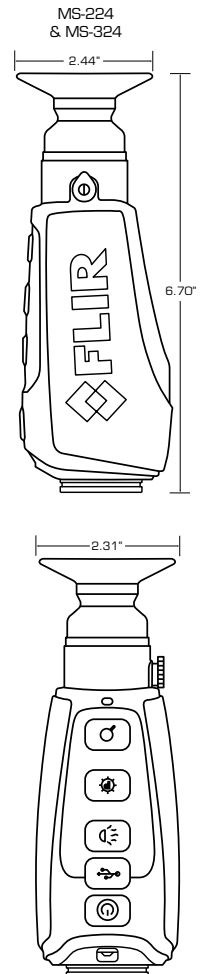

See at Night.

First Mate II HM-Series



The most versatile thermal handheld available, First Mate II HM-Series can be customized to achieve optimal performance for you. Resolution and optics configuration options enable *you* to detect a person 1,050 feet away with HM-224 or up to 5,000 feet away with HM-307 XP+. Still image and video storage is available if you need it. And length and weight are also variable depending on lens choice or if you want the optional 2x extender. You can configure your HM-Series to how you want to use it on your boat, as well as at home or on the trail.

Learn more at www.FLIR.com/HM-Series.

Key Features:

- **InstAlert detection:** By adding a red highlight to the hottest elements in a scene, day or night, the First Mate II will help you locate a man-overboard faster than any other technology available.
- **Video out:** Connect a video monitor to HM-Series' RCA jack to view or record NTSC or PAL composite video.
- **SD card capability:** HM-224 Pro, HM-324XP+ and HM-307XP+ offer image/video storage.
- **Compact & dependable:** Submersible to 1 meter. You'll rely on it often, night and day.

First Mate II HM-Series Control Panel

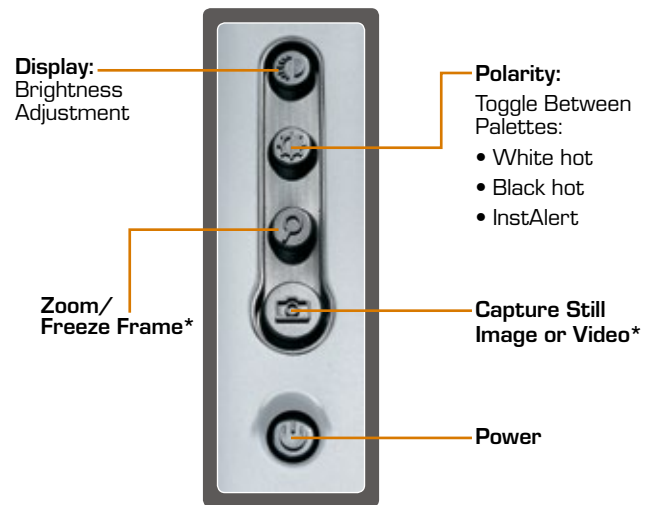

* These features available on specific camera configurations



Home Security: Investigate strange noises



Portable thermal systems go anywhere

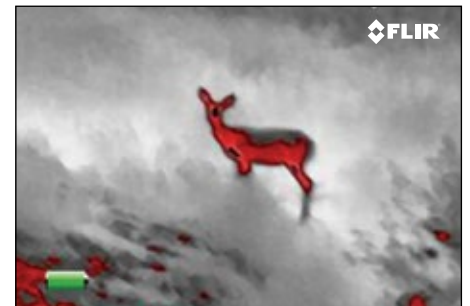

NEW: InstAlert™

Stay Safe.

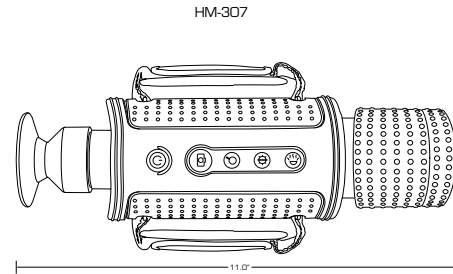
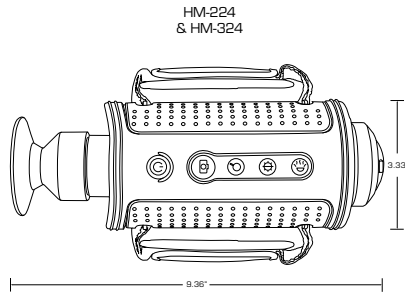

Thermal Imaging Specifications	HM-224	HM-224 Pro	HM-324 XP+	HM-307 XP+
Detector Type	240 x 180 VOx Microbolometer		320 x 240 VOx Microbolometer	
FOV	24° x 18° NTSC			7° x 5° NTSC
Focal Length	19 mm			65 mm
Waveband	7.5 - 13.5 μm			
Start-up Time (From Stand-By)	< 5 seconds			
Focus	Fixed			
Image Processing	FLIR Proprietary Digital Detail Enhancement			
User Interface				
Power Button	On/Off/Stand-By			
Picture Button	Freeze Frame	Still image capture and video capture to SD card		
Zoom Button	N/A	2x E-Zoom		
Polarity	Toggles White Hot, Black Hot, InstAlert			
Brightness	Adjusts Display Brightness			
Image Presentation				
Built-In Display	Color LCD Display			
Video Output	NTSC or PAL composite video; RCA jack			
Video Refresh Rate	<9 Hz			
Image Polarity	White Hot; Black Hot; InstAlert			
Other				
SD Card	—	Stores still images	Stores still images and video	Stores still images and video
Power				
Battery Type	4 Rechargeable AA Batteries; NiMH, Li-Ion, or Alkaline			
Battery Life (Operating)	>5 Hours On NiMH batteries			
Battery Life (Stand-By)	120 Hours on NiMH batteries			
Environmental				
Rating	IP-67			
Operating Temp.	32°F to 122°F (0°C to 50°C)		-4°F to 122°F (-20°C to 50°C)	
Physical				
Weight (incl. lens)	1.45 lb (653 g) with batteries			2.2 lb (984 g) with batteries
Size (L x W x H)	9.36" x 3.3" x 2.6" (10.5" x 3.3" x 2.6" w/ Extender)			11" x 3.33" x 2.62" (279.4 x 84.5 x 66.5 mm)
Packages Include	HM-Series Handheld Thermal Camera, Hot Shoe Charging & Video Output Accessory, 4 Rechargeable AA Batteries, AC Power Adapter/Charger, Neck Lanyard, Operator's Manual, Video Output Cable.			
Thermal Range Performance†				
Detect Man (1.8 m x 0.5 m)	~1,050 ft (0.17 nm)		~1,600 ft (0.26 nm)	~4,800 ft (0.79 nm)
Detect Small Vessel (2.3 m x 2.3 m)	~2,940 ft (0.48 nm)		~4,900 ft (0.80 nm)	~2 nm
Warranty	3 Year (with product registration)			

See at Night.

MD-Series

This affordable, fixed-mount thermal night vision system helps with steering around obstacles, collision avoidance and finding people in the water at night. Simple to mount and easy to integrate into your existing electronics, MD-Series' outputs standard analog video that can be easily displayed on any monitor at the helm or other monitors on the vessel.

Key Features:

- Available in 320 x 240 and 640 x 480 resolutions
- 2x e-zoom standard; 4x e-zoom included on MD-625
- Ethernet-enabled for simple integration into your current electronics
- Compact, all weather, water proof enclosure provides for easy mounting options
- Ball up or ball down mounting options

Learn more at www.FLIR.com/MD-Series.



Thermal Imaging Specification	MD-324	MD-625
Sensor Type	320 x 240 VOx Microbolometer	640 x 480 VOx Microbolometer
FOV	24° x 18° (NTSC)	25° x 20° (NTSC)
Focal Length	19 mm	25 mm
E-zoom	2x	2x, 4x
Image Processing	FLIR Proprietary Digital Detail Enhancement	
System Specifications		
Size	6" dia. x 7" ht.	
Weight	~ 3 lbs	
Pan/Tilt Adjustment Range	Pan: ±30° per key, Tilt: +34°, -27° (Locked in at Installation)	
Video Output	NTSC or PAL, 30 Hz or <9 Hz	
Connector Types	F-type BNC with BNC-to-RCA adapter included for video out	
Power Requirements	PoE injector required per IEEE 802.3af	
PoE Injector Power Requirement	12-24 VDC	
Power Consumption	4.8 W nominal; 12.5 W max	
Environmental		
Operating Temperature Range	-13°F to +131°F (-25°C to +55°C)	
Storage Temperature Range	-40°F to +185°F (-40°C to +85°C)	
Automatic Window Defrost	Standard at Power-Up	
Sand/Dust	Mil-Std-810E	
Water Ingress	IPx6 (heavy seas, powerful jets of water)	
Shock	15 g vertical, 9 g horizontal	
Vibration	IEC 60945; MIL-STD-810E	
Lightning Protection	Standard	
Salt Mist	IEC60945	
Wind	100 knot (115.2 mph)	
EMI	IEC 60945	
Thermal Range Performance		
Detect Man (1.8 m x 0.5 m)	~1,500 ft (0.24 nm)	~2,700 ft (0.44 nm)
Detect Small Vessel (2.3 m x 2.3 m)	~4,200 ft (0.67 nm)	~1.2 nm
Standard Package		
Camera Head with 11" pigtails, 25' Analog Video cable, 25' Ethernet cable, PoE injector and Operator Manual CD		
Warranty		
3 Year (with product registration)		
Optional Accessories		
Low Smoke Zero Halogen Ethernet Cables		

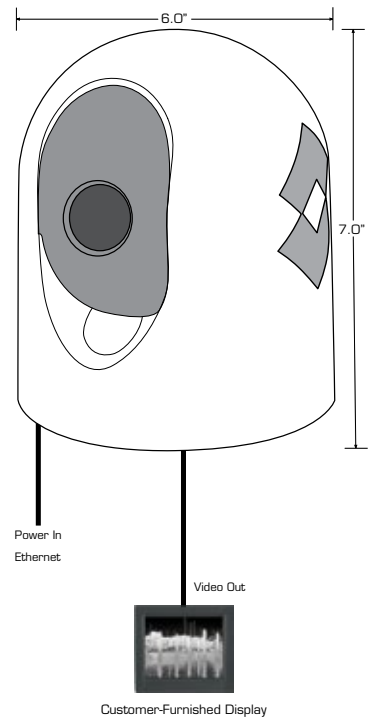

Stay Safe.

M-Series®

The award-winning M-Series is FLIR's premium line of maritime thermal night vision systems. Available with a variety of sensors and resolutions to meet a wide range of maritime navigation, collision avoidance, security, and search and rescue needs, M-Series is easy to install, integrate and operate.

M-Series systems use Ethernet connectivity for easy installation, control, and interface with other onboard electronics. The rugged, waterproof gimbal enclosure provides a continuous 360° pan and a +/-90° tilt field of regard.



Dual payload M-Series with thermal and low-light cameras

Single payload M-Series with thermal camera.



Key Features:

- Available in 320 x 240 standard resolution or 640 x 480 high-resolution thermal vision (higher resolution provides improved image detail and range performance).
- 2x e-zoom standard on all models (high-resolution models also include 4x e-zoom).
- Mount ball-up or ball-down.
- Dual-payload versions include extreme lowlight micro-lux TV camera for improved visibility in low ambient light.
- M-618CS gyro-stabilization provides steady imagery even in rough seas. Mounts ball up only
- On screen position feedback

Learn more at www.FLIR.com/M-Series.



Black hot

White hot



Red hot

Fusion

Rainbow



High-resolution detail image



Low-light Video

See at Night.

Joystick Control Unit

Ergonomic, effortless control of all critical M-Series functions, even in rough conditions

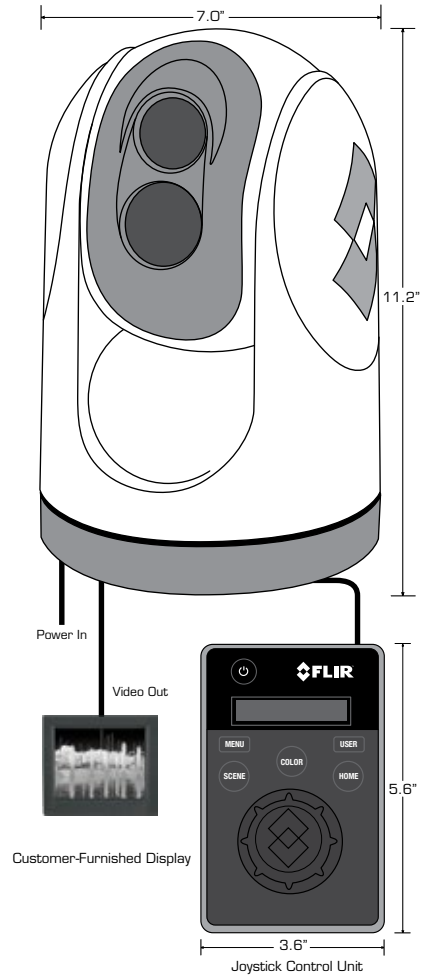
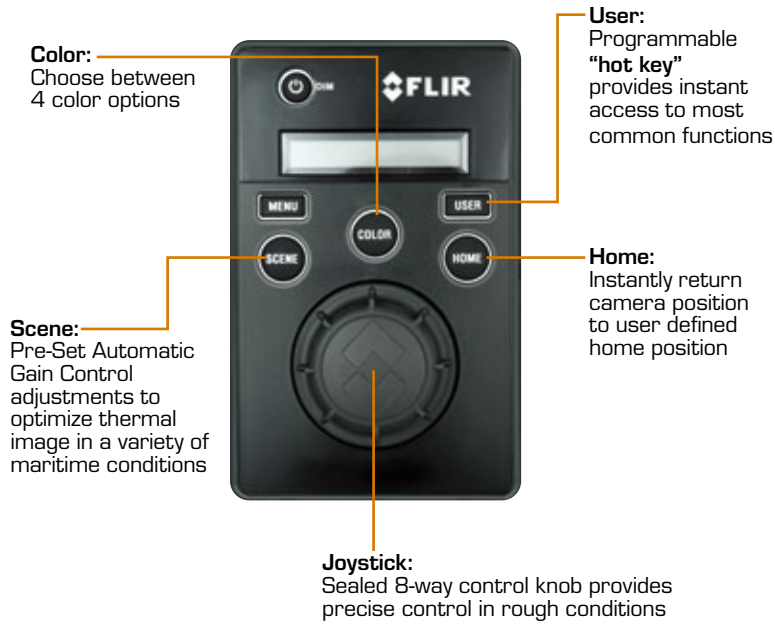

Other Features:

- **Heated LCD Screen:** Instant, always legible system status display.
- **Auto Scan Controls:** Program automatic scan speed and pointing angle arc ranging from 40° to 160°
- **Ethernet Connectivity:** Install Multiple control stations to control M-Series from Anywhere on your Vessel



On-Screen Icons

M-Series uses FLIR's color on-screen symbology to let you see where the system is pointing, and to give you instantaneous updates regarding the camera's configuration and status.



Stay Safe.

M-Series



Thermal Imaging Specifications	M-324XP	M-625XP	M-324L	M-625L	M-618CS
Sensor Type	320 x 240 VOx Microbolometer	640 x 480 VOx Microbolometer	320 x 240 VOx Microbolometer	640 x 480 VOx Microbolometer	640 x 480 VOx Microbolometer
FOV	24° x 18° (NTSC)	25° x 20° (NTSC)	24° x 18° (NTSC)	25° x 20° (NTSC)	18° x 14° (NTSC)
Focal Length	19 mm	25 mm	19 mm	25 mm	35 mm
E-zoom	2x	2x & 4x	2x	2x & 4x	2x & 4x
Image Processing	FLIR Proprietary Digital Detail Enhancement				
Daylight Imaging Specifications					
Detector Type		N/A	1/2" Interline Transfer Lowlight CCD		Color CCD
Lines of Resolution		N/A	768 (H) x 494 (V)		530
Minimum Illumination		N/A	100 µlx (@ f/1.4)		1.4 lux
FOV		N/A	Matched to IR		~58° (h) x 43° (V) w/10x optical zoom matched to IR
System Specifications					
Size	7" dia. x 11.2" ht.				7" dia. x 11.4" ht.
Weight	~ 9 lbs				~ 11.5 lbs
Pan/Tilt Coverage	360° Continuous Pan, +/-90° Tilt				
Video Output	NTSC or PAL				
Connector Types	BNC with BNC-to-RCA adapter included for video out				
Power Requirements	12 VDC to 24 VDC (-10%/+30%)				
Power Consumption	25 W nominal; 50 W max				
Environmental					
Operating Temperature Range	-13°F to +131°F (-25°C to +55°C)				
Storage Temperature Range	-40°F to +185°F (-40°C to +85°C)				
Automatic Window Defrost	Standard				
Sand/Dust	Mil-Std-810E				
Water Ingress	IPx6 (heavy seas, powerful jets of water)				
Shock	15 g vertical, 9 g horizontal				
Vibration	IEC 60945; MIL-STD-810E				
Lightning Protection	Standard				
Salt Mist	IEC60945				
Wind	100 knot (115.2 mph)				
EMI	IEC 60945				
Thermal Range Performance¹					
Detect Man (1.8 m x 0.5 m)	~1,500 ft	~2,700 ft (0.44 nm)	~1,500 ft (0.24 nm)	~2,700 ft (0.44 nm)	~3,900 ft (0.64 nm)
Detect Small Vessel (2.3 m x 2.3 m)	~4,200 ft	~1.2 nm	~4,200 ft (0.67 nm)	~1.2 nm	~1.7 nm
Standard Package					
Camera Head with 18-inch Pigtailed for Power, Analog Video, and Ethernet; Joystick Control Unit; 25' LSZH Ethernet Cable, Operator Manual					
Warranty					
3 Year (with product registration)					
Optional Accessories					
Dual Station JCU; Low Smoke Zero Halogen Ethernet Cables; Top-Down Mounting Riser					

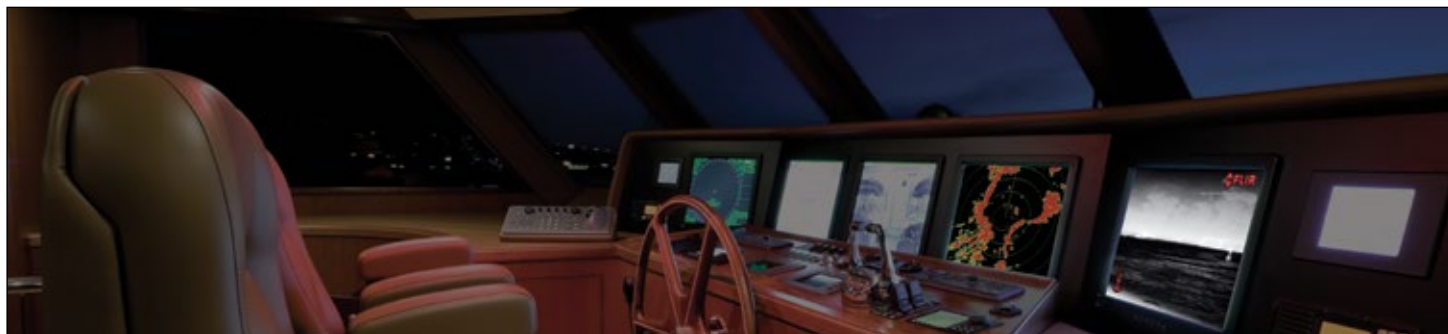

See at Night.

Voyager Series



Long-Range Multi-Sensor Thermal Night Vision Systems

With two best-in-class thermal night vision cameras, and a dual-function daylight/lowlight color TV camera that lets you see harbor entrances and other vessels clearly in the half-light of dawn and dusk, the Voyager family provides 24-hour imaging capability that lets you see to the horizon.

Voyager's wide-angle thermal camera lets you detect other boats or hazards more easily, while its long-range 140 mm thermal camera lets you zoom in on them to get the valuable information you need to react in time.

Learn more at www.FLIR.com/Voyager

Key Features:

Voyager II & III

- **4x optical zoom & 15x total zoom:** Voyager II & III lets you see even farther at night
- **Powerful, long-range daylight/lowlight color TV camera:** With 26x optical zoom, and 312x digital zoom
- **Active gyro-stabilization:** Provides steady imagery, even in rough seas, which is critical for getting the most out of Voyager's long range imaging capability
- **Radar Tracking†:** Identify and track specified radar returns
- **Internet remote control:** Operates Voyager from anywhere in the world with a suitable Internet connection
- **Expanded interface capability:** Integrates Voyager feed with other marine electronics

Voyager III

- **Video Tracker:** Automatically stays locked onto an object or vessel to follow its every movement
- **Temperature Indication Scale:** Determines temperature of objects in image
- **Surveillance Mode:** Automatically pans left and right

† = Some Maritime Radars do not output the NMEA 0183 data required for this feature.



Voyager Zoom



Stay Safe.

Voyager III Joystick Control Unit

Ergonomic, effortless control of all critical Voyager III functions, even in rough conditions

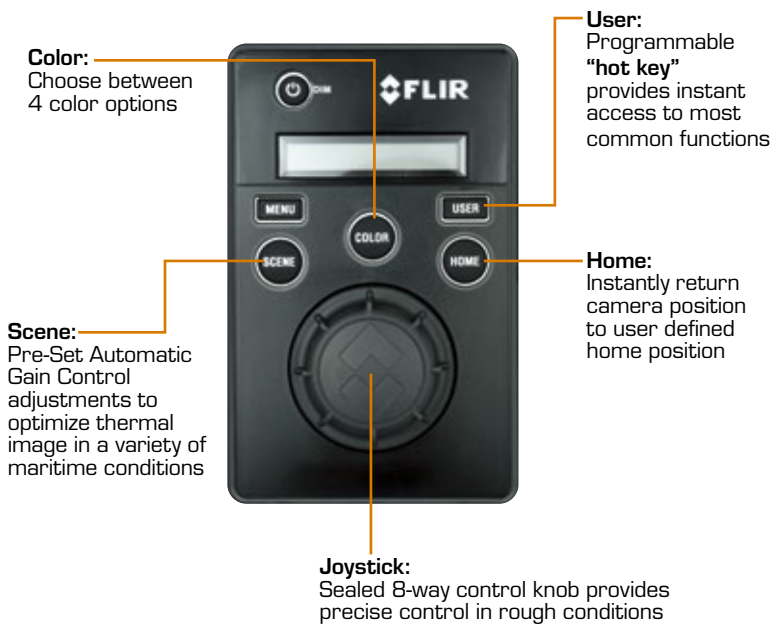

On-Screen Icons

Voyager uses FLIR's color on-screen symbology to let you see where the system is pointing, and to give you instantaneous updates regarding the camera's configuration and status.



Black hot

White hot



Video



Red hot

Fusion

Rainbow



Temperature Indication



Foveal View



Video Tracker

Other Features:

- **Heated LCD Screen:** Instant, always legible system status display.
- **Auto Scan Controls:** Program automatic scan speed and pointing angle arc ranging from 40° to 160°
- **Ethernet Connectivity:** Install Multiple control stations to control Voyager Series from Anywhere on your Vessel

*Some models of Voyager feature alternate joystick control units.

See at Night.

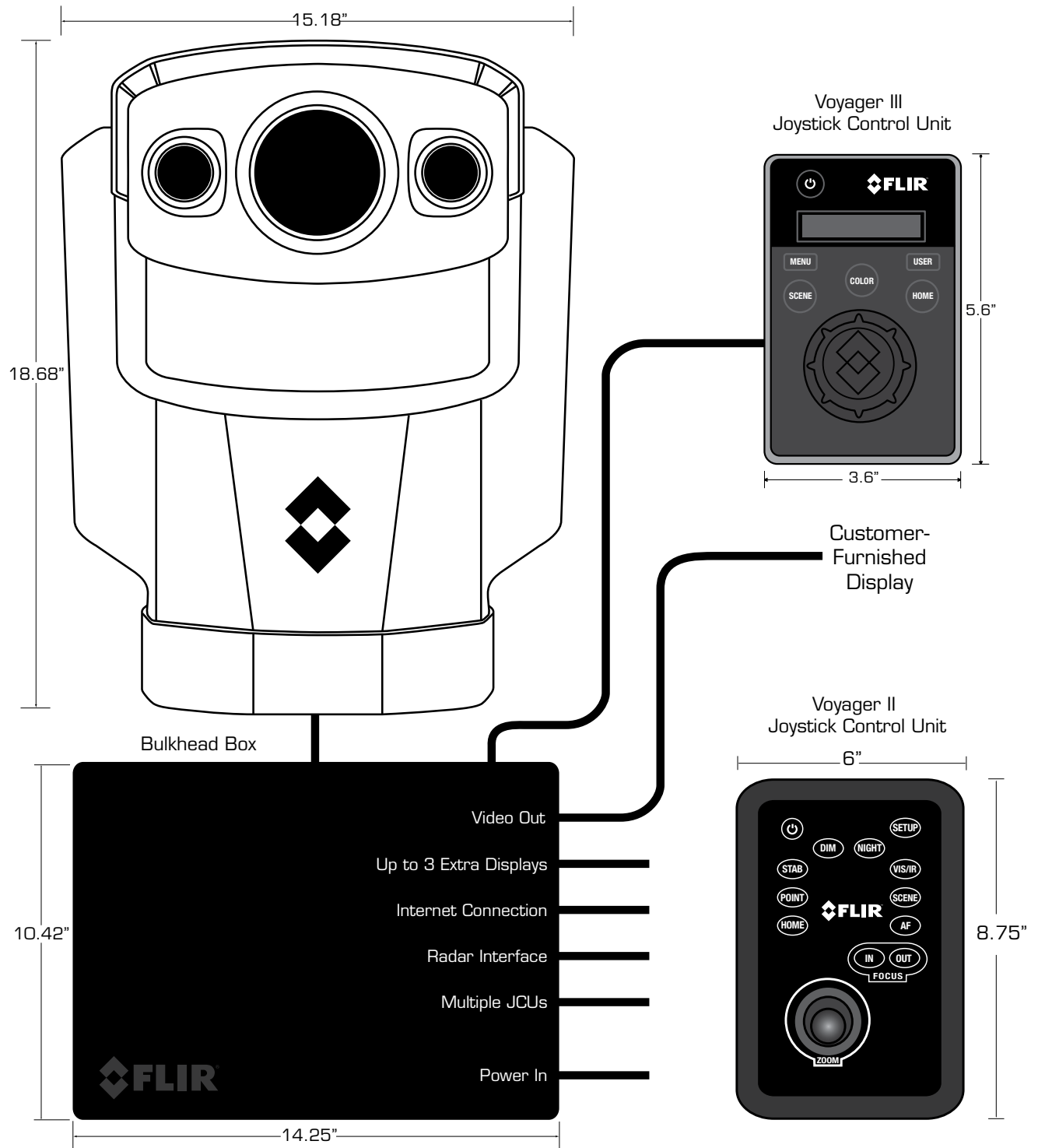

Stay Safe.



Voyager II & Voyager III

Thermal Imaging Specifications	
Sensor Type	Two 320 x 240 VOx Microbolometers
FOV	20° x 15° (Wide FOV); 5° x 3.75° (Narrow FOV)
Focal Length	35 mm (Wide FOV); 140 mm (Narrow FOV)
E-zoom	4x (15x Total Magnification)
Image Processing	FLIR DDE
Daylight Imaging Specifications	
Detector Type	1/4" Super HAD Daylight/Lowlight Color CCD
Lines of Resolution	768 (H) x 494 (V)
Minimum Illumination	2 lux (@ f/1.6)
FOV	42° (h) to 1.7° (h) plus 12x E-zoom for 312x Total Magnification
System Specifications	
Camera Head Size	15.18" x 18.68"; 15.5" x 22" Swept Volume Cylinder
Bulkhead Box	10.42"(w) x 14.25"(l) x 6.26"(d)
Weight	45 lb
Pan/Tilt Coverage	360° Continuous Pan, +/-90° Tilt
Video Output	NTSC or PAL
Connector Types	BNC
Power Requirements	24 VDC
Power Consumption	<50 W nominal; 130 W peak, 270 W w/heaters
Environmental	
Operating Temperature Range	-4°F to 131°F (-20°C to 55°C)
Storage Temperature Range	-58°F to 176°F (-50°C to 80°C)
Automatic Window Defrost	Standard
Thermal Range Performance†	
Detect Man (1.8 m x 0.5 m)	~1.2 nm
Detect Small Vessel (2.3 m x 2.3 m)	~3.4 nm
Typical Configuration	
	Camera Head; Bulkhead Box; Joystick Control Unit; Cables; Operator Manual
Warranty	
	2 Year

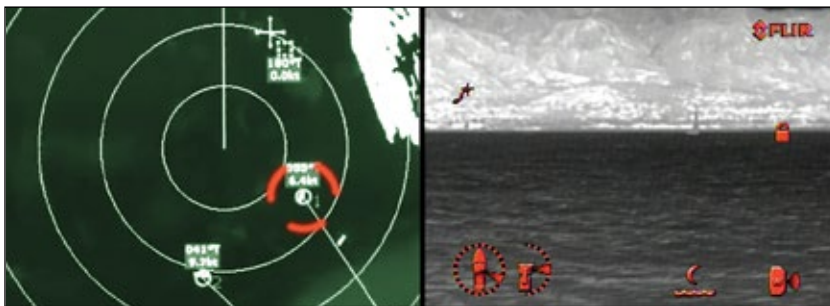

Voyager Series Radar Tracking

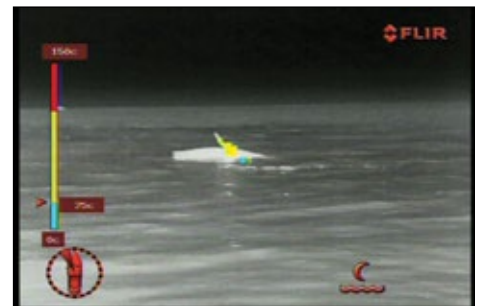

Voyager III Temperature measurement

See at Night.

Resolution Matters

When people talk about a thermal camera's resolution, they're talking about the number of pixels used to capture thermal energy. The bigger the number, the higher the camera's resolution. The higher the resolution, the more pixels you have gathering energy. This means that a higher resolution camera will typically let you see more detail, see smaller objects, and see them from farther away.

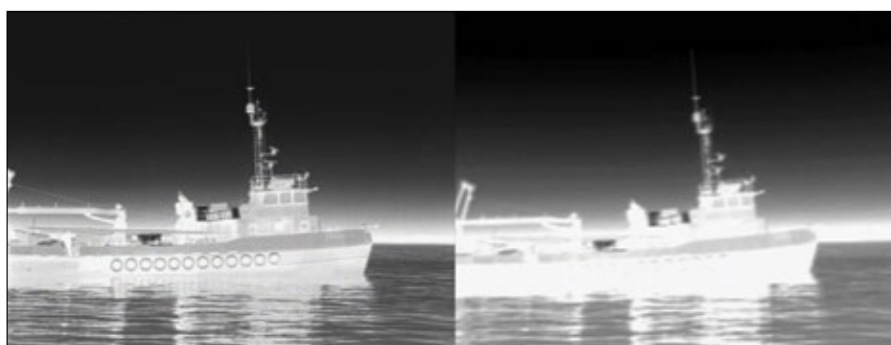

640 x 480

320 x 240

What's a Field of View, and Why Do I Care?

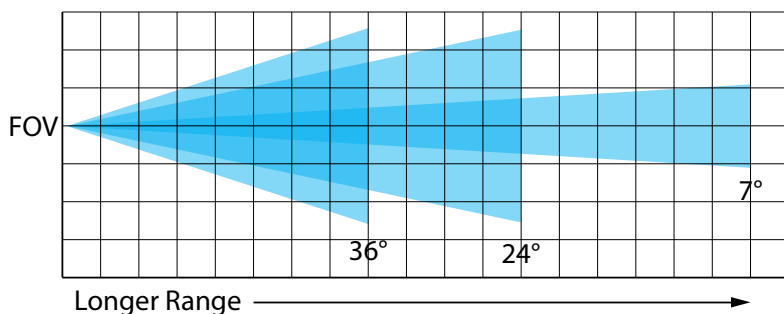

19mm lens at 50yds



35mm lens at 50yds



65mm lens at 50yds

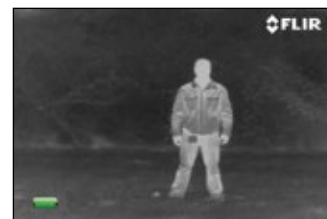

100mm lens at 50yds

A camera's field of view (FOV) is the angular measurement of the area the lens can see. The wider the FOV the more you can see from side to side; the narrower the FOV the farther away you can see things. So, a 24° FOV is good for general viewing, collision avoidance, and hazard or man overboard detection, while a 7° FOV is better for seeing other vessels, hazards, and obstructions from farther away. While narrower fields of view help you see farther, they need to be steady to be most effective, so they can be more difficult to use as seas get heavier.

Stay Safe.

FLIR.com/Maritime

There's no better way to fully comprehend the power of thermal imaging than to try a camera for yourself. The next best thing is watching thermal video, which is exactly what you can do at www.FLIR.com/Maritime. You can also try the First Mate II Product Selector and thermal simulator, read about the different ways thermal imaging is used in a maritime environment, and learn more about all FLIR thermal night vision systems for maritime use.

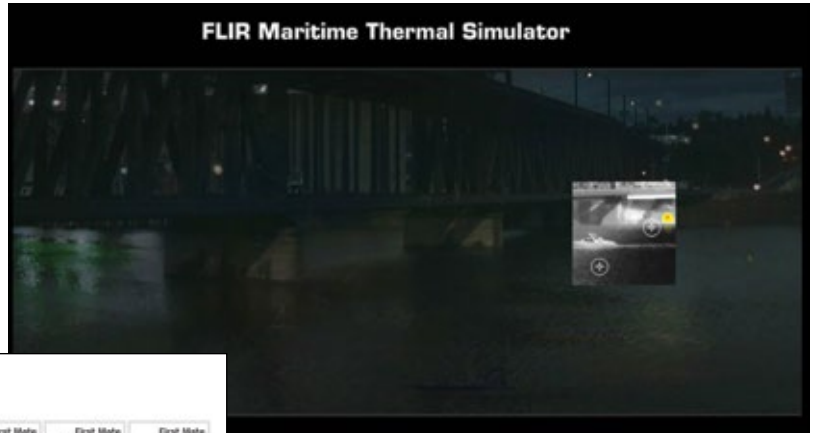

Visit FLIR.com/Maritime and try the new Maritime Thermal Simulator

Compare FLIR First Mate Models
Not sure which model is best for you? Select models below to compare.

Compare products
You have no items to compare.

Filter Options

Range - Detection of a Small Vessel
[Input field]

Detector Resolution
 344x256 640x480
 320x240 640x480

Digital Still Image Storage
 Required Not Required

Digital Video Storage
 Required Not Required

Analog Video Out
 Required Not Required

Show all

Note: Actual range may vary depending on camera setup, environmental conditions, user experience, and display method. Thermal images shown are for illustrative purposes only, and may not have been taken by the camera series depicted.

Compare products online with the First Mate II Product Selector

About FLIR Systems

As the world's largest commercial infrared company, FLIR Systems has fielded more high-quality maritime thermal night vision systems than anyone in the world. Our rugged, stabilized imagers are on thousands of civil and maritime platforms in the U.S. and around the world, more than every other manufacturer combined.

With thousands of our thermal cameras on the job in military, scientific, law enforcement, and security applications, FLIR brings an unmatched level of experience and dedication to the creation of cutting-edge thermal night vision systems. We design and manufacture all critical technologies inside our products, including detectors, electronics, and special lenses, and we assemble it all right here in the U.S.

Whether you're heading out early, coming home late, or cruising around the clock, FLIR has a thermal night vision system to meet your needs.





PORTLAND
Corporate Headquarters
FLIR Systems, Inc.
27700 SW Parkway Ave.
Wilsonville, OR 97070
USA
PH: +1 877.545.5094

NASDAQ: FLIR