

GARMIN.

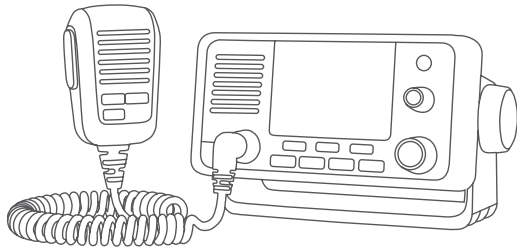

## VHF 115/215 AIS SERIES INSTALLATION INSTRUCTIONS

### Important Safety Information

#### ⚠ WARNING

See the *Important Safety and Product Information* guide in the product box for product warnings and other important information.

#### ⚠ CAUTION

Always wear safety goggles, ear protection, and a dust mask when drilling, cutting, or sanding.

#### NOTICE

When drilling or cutting, always check what is on the opposite side of the surface.

### Registering Your Device

Help us better support you by completing our online registration today. Keep the original sales receipt, or a photocopy, in a safe place.

- 1 Go to [garmin.com/express](http://garmin.com/express).
- 2 Sign in to your Garmin® account.

### Mounting Considerations

#### NOTICE

This device should be mounted in a location that is not exposed to extreme temperatures or conditions. The temperature range for this device is listed in the product specifications. Extended exposure to temperatures exceeding the specified temperature range, in storage or operating conditions, may cause device failure. Extreme-temperature-induced damage and related consequences are not covered by the warranty.

When selecting a mounting location, you should observe these considerations.

- The location should provide optimal viewing as you operate your boat.
- The location should allow for easy access to all device interfaces, such as the keypad, touchscreen, and card reader, if applicable.
- The location must be strong enough to support the weight of the device and protect it from excessive vibration or shock.
- To avoid interference with a magnetic compass, the device should not be installed closer to a compass than the compass-safe distance value listed in the product specifications.
- The location must allow room for the routing and connection of all cables.
- The location must not be a flat, horizontal surface. The location should be in a vertical angle.

The location and viewing angle should be tested before you install the device. High viewing angles from above and below the display may result in a poor image.

### Antenna Mounting and EME Exposure

#### ⚠ WARNING

Radio operators with cardiac pacemakers, life-support machines, or electrical medical equipment should not be exposed to excessive radio-frequency (RF) fields, because the RF field may interfere with the function of their medical equipment.

#### ⚠ CAUTION

This device generates and radiates radio frequency (RF) electromagnetic energy (EME). Failure to observe these guidelines may expose people to RF radiation absorption exceeding the maximum permissible exposure (MPE).

Garmin declares a MPE radius of 2.48 m (97.64 in.) for this system, which was determined using 5 W output to an omnidirectional, 6 dBi gain antenna. The antenna should be installed to maintain a distance of 2.48 m (97.64 in.) between the antenna and all people.

### Bail Mounting the Device

#### NOTICE

If you are mounting the bracket on fiberglass with screws, it is recommended to use a countersink bit to drill a clearance counterbore through only the top gel-coat layer. This will help to avoid cracking in the gel-coat layer when the screws are tightened.

You can use the included bracket to bail mount the device on a flat surface.

- 1 Using the bail-mount bracket ① as a template, mark the pilot holes.

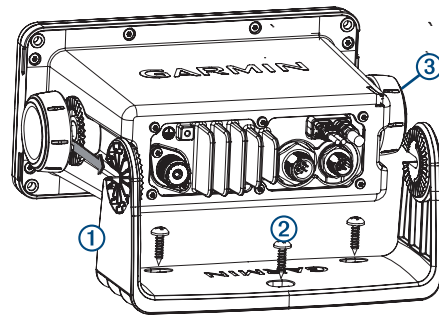

- 2 Using a 3.5 mm (<sup>9</sup>/<sub>64</sub> in.) drill bit, drill the pilot holes.
- 3 Using the included screws ②, secure the bail-mount bracket to the mounting surface.
- 4 Install the bail-mount knobs ③ on the sides of the device.
- 5 Place the device in the bail-mount bracket and tighten the bail-mount knobs.

### Flush Mounting the Device

#### NOTICE

Be careful when cutting the hole to flush mount the device. There is only a small amount of clearance between the case and the mounting holes, and cutting the hole too large could compromise the stability of the device after it is mounted.

If you are mounting the bracket on fiberglass with screws, it is recommended to use a countersink bit to drill a clearance counterbore through only the top gel-coat layer. This will help to avoid cracking in the gel-coat layer when the screws are tightened.

The included template and hardware can be used to mount the device in your dashboard.

- 1 Trim the template and make sure it fits in the location where you want to mount the device.
- 2 Using a 9.5 mm ( $3/8$  in.) drill bit, drill one or more of the holes inside the corners of the solid line on the template to prepare the mounting surface for cutting.
- 3 Using a jigsaw or rotary tool, cut the mounting surface along the inside of the solid line indicated on the template.
- 4 Place the device in the cutout to test the fit.
- 5 If necessary, use a file and sandpaper to refine the size of the cutout.
- 6 After the device fits correctly in the cutout, ensure the mounting holes on the device line up with the pilot holes on the template.
- 7 If the mounting holes on the device do not line up, mark the new pilot-hole locations.
- 8 Using a 3.5 mm ( $9/64$  in.) drill bit, drill the pilot holes.
- 9 Remove the template from the mounting surface.
- 10 If you will not have access to the back of the device after you mount it, connect all necessary cables to the device before placing it into the cutout.
- 11 If necessary, cover unused connectors with the attached weather caps to prevent corrosion of the metal contacts.
- 12 Install the foam gasket ① on the back of the device.  
The pieces of the rubber gasket have adhesive on the back. Make sure you remove the protective liner before installing them on the device.

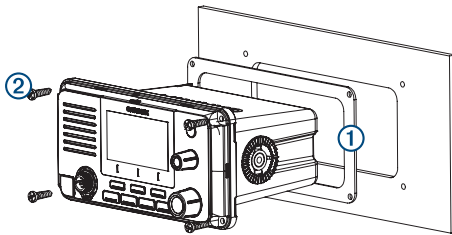

- 13 Place the device in the cutout.
- 14 Secure the device to the mounting surface using the included screws ②.
- 15 Install the decorative bezel by snapping it in place around the edges of the device.

### Mounting the Microphone Hanger

#### NOTICE

If you are mounting the bracket on fiberglass with screws, it is recommended to use a countersink bit to drill a clearance counterbore through only the top gel-coat layer. This will help to avoid cracking in the gel-coat layer when the screws are tightened.

You can mount the microphone hanger in a convenient location near the radio.

- 1 Select a mounting location for the microphone within reach of the microphone cable.
- 2 Using the microphone hanger ① as a template, mark the pilot holes.

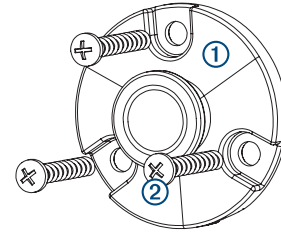

- 3 Drill the mounting holes using a 3 mm ( $1/8$  in.) drill bit.
- 4 Secure the microphone hanger to the mounting surface using the included screws ②.

### Connection Considerations

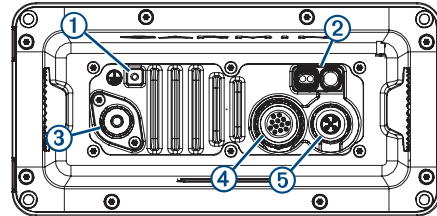

Item	Description	Notes
①	Ground connection	You can use the included grounding screw to connect the device chassis to water ground, if needed ( <a href="#">Additional Grounding Considerations, page 2</a> ).
②	Power and data wiring harnesses	You must connect the device to a 12 Vdc power source ( <a href="#">Connecting the Wiring Harness to Power, page 2</a> ). You can connect this device to a NMEA® 0183 device using this wiring harness to share DSC and GPS information (optional) ( <a href="#">NMEA 0183 Device Connections, page 3</a> ). You can connect this device to an external GPS antenna using this wiring harness (optional) ( <a href="#">Connecting to a Remote GPS Antenna, page 3</a> ). You can connect this device to a hailer horn using this wiring harness (optional) ( <a href="#">Connecting to a Hailer Horn or PA Speaker, page 3</a> ). You can connect this device to an external speaker using this wiring harness (optional) ( <a href="#">Connecting to an External Speaker, page 3</a> ).
③	VHF antenna connection	You must connect the device to a VHF antenna (sold separately) ( <a href="#">Connecting a VHF Antenna, page 3</a> ).
④	Additional microphone connector	You can add an additional microphone (sold separately) or relocate the existing microphone on a VHF 215 AIS radio (microphone relocation kit sold separately). This connector is not available on a VHF 115 radio.
⑤	NMEA 2000® connector	You can connect this device to a NMEA 2000 network on your boat to share DSC and GPS information (optional) ( <a href="#">NMEA 2000 Device Connections, page 3</a> ).

### Connecting the Wiring Harness to Power

- 1 Route the wiring harness to the power source and to the device.
- 2 Connect the red wire to the positive (+) battery terminal, and connect the black wire to the negative (-) battery terminal.

#### Additional Grounding Considerations

This device should not need any additional chassis grounding in most installation situations. If interference is experienced, the grounding screw on the housing can be used to connect the

device to the water ground of the boat to help avoid the interference.

### Connecting a VHF Antenna

- 1 Mount the VHF antenna (sold separately) according to the installation instructions provided with the antenna.

**NOTE:** You can purchase a VHF extension cable. Go to <http://buy.garmin.com> or contact your Garmin dealer.

- 2 Connect the VHF antenna to the port on the VHF 115/215 AIS device.

### NMEA 2000 Device Connections

#### NOTICE

If you are installing a NMEA 2000 power cable, you must connect it to the boat ignition switch or through another in-line switch. NMEA 2000 devices will drain your battery if the NMEA 2000 power cable is connected to the battery directly.

If you are unfamiliar with NMEA 2000, you should read the "NMEA 2000 Network Fundamentals" chapter of the *Technical Reference for NMEA 2000 Products*. Go to [www.garmin.com/manuals/VHF115-215](http://www.garmin.com/manuals/VHF115-215).

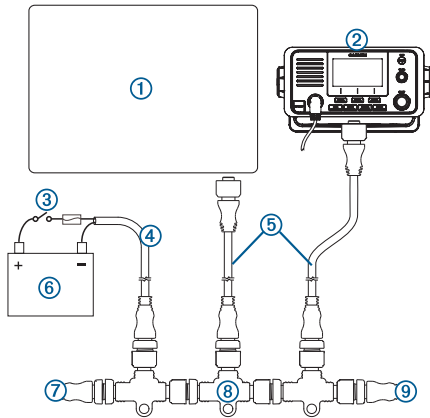

Item	Description
①	Compatible NMEA 2000 chartplotter or other device
②	VHF 115/215 AIS device
③	Ignition or in-line switch
④	NMEA 2000 power cable
⑤	NMEA 2000 drop cable
⑥	12 Vdc power source
⑦	NMEA 2000 terminator or backbone cable
⑧	NMEA 2000 T-connector
⑨	NMEA 2000 terminator or backbone cable

### Connecting to a Remote GPS Antenna

This device includes an internal GPS antenna. If your mounting location does not provide good GPS reception, you may install a remote GPS antenna with a female BNC connector (not included), and connect it to the device.

**NOTE:** If you connected this device to a NMEA 2000 with a GPS antenna, you can use that antenna as a GPS source instead of installing a remote GPS antenna (*NMEA 2000 Device Connections, page 3*).

- 1 Follow the instructions provided with the external GPS antenna to install it on your boat correctly.
- 2 Route the GPS antenna cable to the back of the VHF 115/215 AIS device, away from sources of electrical interference.
- 3 Connect the GPS antenna cable to the BNC connector on the wiring harness on the VHF 115/215 AIS device.

### NMEA 0183 Device Connections

This diagram illustrates two-way connections for both sending and receiving data. You can also use this diagram for one-way communication. To receive information from a NMEA 0183 device on this device, refer to items ①, ②, ④, and ⑤ in the second table. To transmit information to a NMEA 0183 device from this device, refer to items ①, ②, ⑥, and ⑦ in the second table.

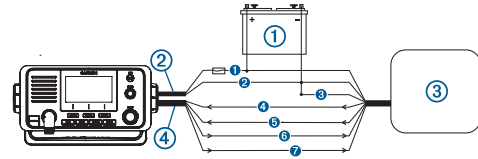

Item	Description
①	Power source
②	Power cable
③	NMEA 0183 device
④	NMEA 0183 cable

Item	Garmin Wire Function	Garmin Wire Color	NMEA 0183 Device Wire Function
①	Power	Red	Power
②	Power ground	Black	Power ground
③	Not applicable	Not applicable	Data ground (if applicable)
④	RxA (+)	Purple	TxA (+)
⑤	RxB (-)	Gray	TxB (-)
⑥	TxA (+)	Blue	RxA (+)
⑦	TxB (-)	Brown	RxB (-)

### Connecting to a Hailer Horn or PA Speaker

You can connect a VHF 215 AIS radio to a hailer horn or public address (PA) speaker (not included) to use the microphone or the handset to make announcements.

**NOTE:** The VHF 115 radio cannot be connected to a hailer horn.

- 1 If necessary, mount the hailer horn or PA speaker according to the installation instructions provided with the device.  
**NOTE:** To avoid feedback, you should mount the hailer horn or PA speaker at least 3 m (10 ft) away from, and facing away from, the microphone or handset.
- 2 Route or extend the wire from the hailer horn or PA speaker to the radio.
- 3 Connect the white wire on the radio wiring harness to the positive (+) wire from the hailer horn or PA speaker.
- 4 Connect the green wire on the radio wiring harness to the negative (-) wire from the hailer horn or PA speaker.
- 5 Cover the connections with a waterproof tape or heat-shrink tubing.

### Connecting to an External Speaker

You can connect the radio to an external speaker (not included) to hear the radio at a remote location.

- 1 If necessary, mount the speaker according to the installation instructions provided with the device.
- 2 Route or extend the wire from the speaker to the radio.
- 3 Connect the red wire on the radio wiring harness to the positive (+) wire from the speaker.
- 4 Connect the black wire on the radio wiring harness to the negative (-) wire from the speaker.
- 5 Cover the connections with a waterproof tape or heat-shrink tubing.

# Appendix

## Specifications

Specification	Measurement
Dimensions (H x W x D)	VHF 115: 8.5 x 17 x 14.6 cm (3.35 x 6.7 x 5.75 in.) VHF 215 AIS: 9.8 x 19.7 x 14.9 cm (3.86 x 7.76 x 5.78 in.)
Weight	VHF 115 (with microphone): 1.241 kg (43.77 oz.) VHF 215 AIS (without microphone): 1.212 kg (42.75 oz.) VHF 215 AIS microphone: 0.248 kg (8.75 oz.)
Temperature range	Operating: From -15° to 70°C (from 5° to 158°F) Storage: From -20° to 70°C (from -4° to 158°F)
Compass-safe distance	VHF 115: 70 cm (27.6 in.) VHF 215 AIS: 75 cm (29.5 in.)
Water rating*	IEC 605290 IPX7
Antenna connector	S0-239 (50 Ω)
Operating voltage	12.0 Vdc
Current draw	Standby: 350 mA Receive: 600 mA Transmit: From 2.0 A to 6.0 A (from 1 W to 25 W)
Maximum antenna gain	9 dBi
Antenna port impedance	50 Ω
Audio output power	Internal speaker: 1 W (with 4 Ω at 10% distortion) External speaker (optional): 4 W (4 Ω/max)
Hailer output power	20 W at 4 Ω
External speaker impedance	4 Ω
Hailer horn impedance	4 Ω

### NOTICE

The device is water resistant to IEC Standard 60529 IPX7. It can withstand accidental immersion in 1 meter of water for 30 minutes. Prolonged submersion can cause damage to the device. After submersion, be certain to wipe dry and air dry the device before using or charging.

### NMEA 2000 PGN Information

Receive		Transmit	
059392	ISO acknowledgment	059392	ISO acknowledgment
059904	ISO request	060928	ISO address claim
060928	ISO address claim	126208	NMEA request/ command/ack
126208	NMEA request/ command/ack	126464	PGN list
129026	COG/SOG, rapid update	126996	Product information
129029	GNSS position data	129799	Radio frequency/mode/ power
		129808	DSC call information

### Transmit (AIS models only)

129038	Class A position report
129039	Class B position report
129040	Class B extended position report

Transmit (AIS models only)	
129794	AIS class A static and voyage related data
129798	AIS SAR aircraft position report
129802	AIS broadcast safety message
129809	AIS class B static data part A
129810	AIS class B static data part B

### NMEA 0183 IN Sentences Supported

Sentence	Definition
GGA	Global positioning system fix data
GLL	Geographic position (latitude/longitude)
GNS	GNSS fix data
RMA	Recommended minimum specific Loran-C data
RMB	Recommended minimum navigation information
RMC	Recommended minimum specific GNSS data

### NMEA 0183 OUT Sentences Supported

Sentence	Definition
DSC	DSC information
DSE	Expanded DSC

© 2018 Garmin Ltd. or its subsidiaries

Garmin® and the Garmin logo are trademarks of Garmin Ltd. or its subsidiaries, registered in the USA and other countries. GHS™ is a trademark of Garmin Ltd. or its subsidiaries. These trademarks may not be used without the express permission of Garmin.

NMEA® and NMEA 2000® are registered trademarks of the National Marine Electronics Association. Other trademarks and trade names are those of their respective owners.

