



TRANSOM TRANSDUCER Installation Guide

532314-4_C

The transom mount installation allows adjustment of both running angle and depth after the transducer is mounted, which enables you to tune the installation for best results.

 **NOTE:** Due to the wide variety of hulls, only general instructions are presented in this installation guide. Each boat hull represents a unique set of requirements that should be evaluated prior to installation. For detailed information about installing transducers on different hull types, download the Transducer Installation Resource Guide from our Web site at humminbird.johnsonoutdoors.com.

 **NOTE:** Your transducer may not look exactly like the transducer shown in the illustrations, but it will mount in exactly the same way.

INSTALLATION PREPARATION

Install the control head before you start the transducer installation. See the control head installation guide.

Review your boat manufacturer's owner's manual for recommended transducer installation locations and cable routing methods. You will also need your transom angle.

Read and understand your boat's warranty before starting this installation.

Read the instructions in this guide completely and understand the mounting guidelines before beginning this installation.

Visit our Web site at humminbird.johnsonoutdoors.com for additional information and resources for transducer installations. Also, visit youtube.com/humminbirdtv for informational videos.

Confirm your boat is level for the installation.

Consider your speed requirements.

Traveling over 65 mph with the transducer in the water is not recommended with the XNT 9 SI 180 T, XNT 9 DB 74 T, XNT 9 MSI 150 T, XNT 9 HW DI T, XNT 9 HW SI T, and XNT 14 74 T transducers, as damage may occur. If speed above 65 mph is critical, see the FAQ [Frequently Asked Questions] section of our Web site at humminbird.johnsonoutdoors.com.

Down Imaging® provides the maximum detail at slower speeds, however, high-speed performance is available in the Down Imaging and traditional sonar views. If high-speed operation is critical with your Down Imaging transducer, you may want to consider an Inside the Hull transducer.

 **SIDE IMAGING® NOTE:** The Side Imaging transducer CANNOT be installed inside the hull of the boat.

Supplies: In addition to the supplied hardware, you will need a powered hand drill and various drill bits, various hand tools, including a ruler or straightedge, a level, a socket driver, marker or pencil, safety glasses and dust mask, marine-grade silicone sealant, dielectric grease [optional], and a 12" plumb line [weighted string or monofilament line [optional]]. You may also need extension cables and hardware for routing the cable to the control head.

TURBULENCE-FREE MOUNTING GUIDELINES

It is very important to locate the transducer in an area that is relatively free of turbulent water. Consider the following to find the best location with the least amount of turbulence:

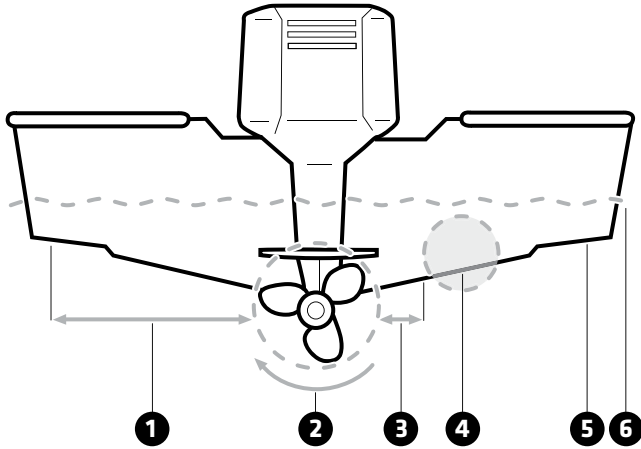

- 1** **Avoid areas where there is turbulent water flow.** Turbulent water is normally confined to areas immediately aft of ribs, strakes, or rivets on the bottom of the boat, and in the immediate area of the propeller[s]. The best way to locate turbulence-free water is to view the transom while the boat is moving.
- 2** **Observe your propeller's direction of rotation** [in forward, as you're facing the stern of the boat from behind]. Clockwise propellers create more turbulence on the port side. Counterclockwise propellers create more on the starboard side.
- 3** **Ensure there is adequate distance from the propeller[s].** On outboard or inboard/outboard boats, it is best to locate the transducer at least 15" [38.1 cm] to the side of the propeller[s].
- 4** **The ideal mounting location [right of the propeller[s]].** It is important to note that if you plan to trailer your boat, do not mount the transducer too close to trailer bunks or rollers to avoid moving or damaging the transducer during loading and unloading of the boat.
- 5** **For boats with stepped hulls,** it may be possible to mount the transducer on the step. Do not mount the transducer on the transom behind a step to avoid popping the transducer out of the water at higher speeds.
- 6** **The transducer must be mounted so that it is parallel with the waterline, but fully submerged in the water during operation.**
- 7** **If you have a Side Imaging transducer,** the transducer must NOT have anything obstructing the 'view' of the side looking beams. For example, nothing can be in the line of sight of these beams [not a hull, motor, or other transducer, etc.]



NOTE: You may need to tilt the motor up and out of the way when using the side looking beams.

Deadrise: The hydrodynamic shape of your transducer allows the sonar beams to point down without deadrise adjustment.

1 | Prepare the Mounting Location

1. Confirm the boat is level on the trailer [both from port to starboard and from bow to stern].
2. Hold the mounting bracket against the transom of the boat in the location you have selected. Align the bracket horizontally, using the level. Make sure that the lower screw hole protrusion does not protrude past the bottom of the hull.

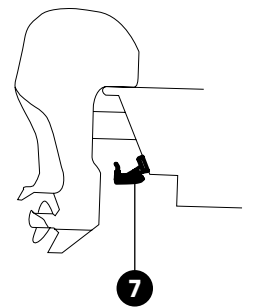

Unobstructed View: This jack plate installation gives the transducer safe distance from the motor and turbulence. The Side Imaging has a clear view side-to-side.

Using the Mounting Bracket to Mark the Initial Drill Holes

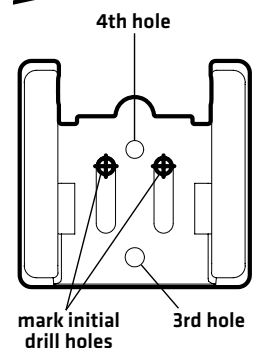
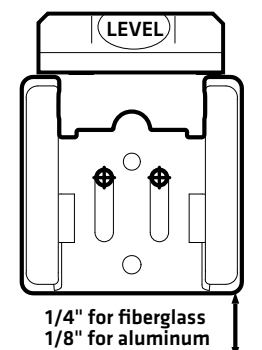

TRANSOM TRANSDUCER Installation Guide

- Refer to the minimum clearance requirement between the bottom of the bracket and the bottom of the transom for your boat type below:

1/4" [6 mm] clearance for fiberglass boats

1/8" [3 mm] clearance for aluminum boats

NOTE FOR ALUMINUM BOATS: For flat-bottomed aluminum boats, some additional adjustment may be needed to accommodate the rivets on the bottom of the boat [the gap may need to be a little smaller than 1/8"]. This will help you to avoid excessive turbulence at high speeds.

If your propeller moves clockwise, mount the transducer on the starboard side, and align the bottom right corner of the mounting bracket with the bottom of the boat. If your propeller moves counterclockwise, mount the transducer on the port side, and align the bottom left corner of the mounting bracket with the bottom of the boat.

- Continue to hold the bracket on the transom of the boat, and use a pencil or marker to mark the two initial drill holes [see *Using the Mounting Bracket to Mark the Initial Drill Holes*]. Mark the drill holes near the top of each slot, making sure that your mark is centered in the slot.

NOTE: The third hole should not be drilled until the angle and height of the transducer is finalized, which you will not do until a later procedure.

- Confirm that the drill bit is perpendicular to the actual surface of the transom, [NOT parallel to the ground], before you drill. Using a 5/32" [4 mm] bit, drill the two holes only to a depth of approximately 1" [25.4 mm].

NOTE FOR FIBERGLASS HULLS: It is best to start with a smaller bit and use progressively larger drill bits to reduce the chance of chipping or flaking the outer fiberglass coating.

2 | Assemble the Transducer and Initial Mounting

In this procedure, you will assemble the transducer using the hardware provided, then mount it and make adjustments to its position without locking it in place.

- 1a. If your transom is angled at 14 degrees [a common transom angle for many boats], use position 1 for the ratchets.
- 1b. If you have a different transom angle or do not know your transom angle, refer to the Transducer Installation Resource Guide on our Web site at humminbird.johnsonoutdoors.com for detailed instructions.
- Place the two ratchets, one on either side of the transducer knuckle, so that the beads on each ratchet line up with the desired position number on the knuckle [see *Installing the Ratchets in Position 1*]. If you are setting the ratchets at position 1, the beads on each ratchet will line up with the rib on the transducer knuckle to form one continuous line on the assembly.

NOTE: The ratchets are keyed. Make sure that the square teeth on each ratchet face the square teeth on the transducer knuckle, and the triangular teeth face outward.

- Hold the ratchets on the transducer knuckle until it snaps into place with the other hand. Refer to the illustration *Fitting the Pivot Arm over the Ratchet*.
- Put the pivot bolt through the assembly to hold it in position and loosely install the nut, but do NOT tighten the nut at this time [see *Inserting the Pivot Bolt*].

CAUTION! Do not use a high speed driver on this combination of fasteners. **Hand-tighten only.**

- Insert the pivot arm assembly into the mounting bracket [see *Inserting the Pivot Arm Assembly into the Mounting Bracket*]. Do NOT snap the assembly closed, as you will need to access the mounting bracket in the next step.

Installing the Ratchets in Position 1

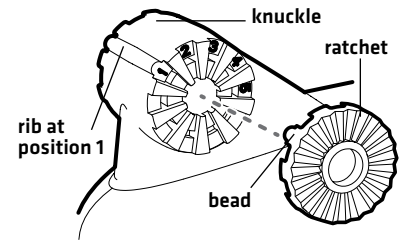

Fitting the Pivot Arm over the Ratchet

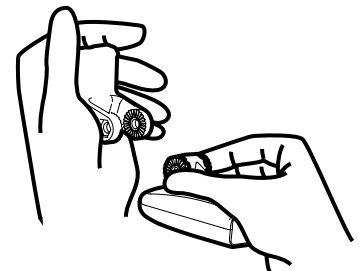

Inserting the Pivot Bolt

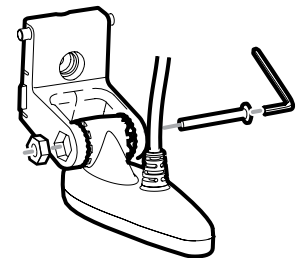

Inserting the Pivot Arm Assembly into the Mounting Bracket

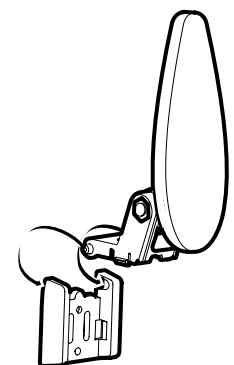

TRANSOM TRANSDUCER Installation Guide

532314-4_C

 **NOTE:** If the pivot assembly is snapped closed over the mounting bracket, use a flat head screwdriver or similar tool to gently pry the assembly away from the mounting bracket.

- Align the mounting bracket transducer assembly with the drilled holes in the transom. With a 5/16" socket driver, mount the assembly to the transom using the two #10 - 1" long screws provided.

 **NOTE:** Make sure that the mounting screws are snug, but do not fully tighten the mounting screws at this time to allow the transducer assembly to slide for adjustment purposes.

- Snap the pivot arm down into place.

3 | Confirm the Mounting Angle

You will need to adjust the initial angle of the transducer both vertically and horizontally to confirm the transducer mounting angle.

- Adjust the transducer assembly vertically, until the seam on the leading edge of the transducer [see **1** below] is level and just slightly below the hull.
- Adjust the initial angle of the transducer from back to front by rotating the transducer until the side seam on the transducer is almost parallel with the bottom of the boat, one click at a time in either direction [see *Adjusting the Initial Transducer Angle*].

Downward Slant: The transducer has a natural downward slant of 4 to 5 degrees from leading edge [closest to the boat transom] to trailing edge [farthest away from the boat]. Looking at the back of the transducer, the seam should be slightly below the bottom of the hull.

Down Imaging Transducers: A downward slant is not required for Down Imaging Transducers. Adjust the running angle so that the transducer is parallel to the water and submerged in the water.

Adjusting the Initial Transducer Angle

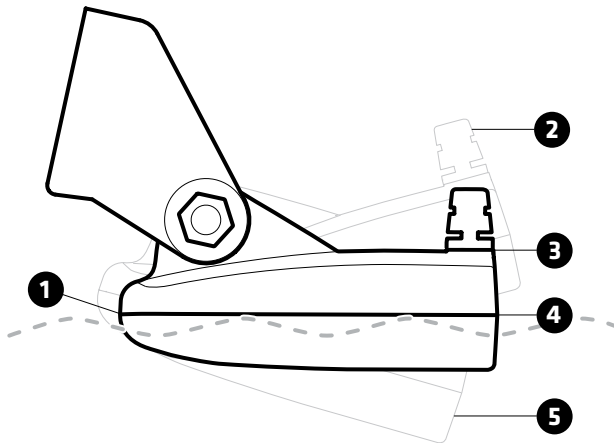

- 1** Leading edge [the edge closest to the transom of the boat].
- 2** One click too high: the transducer is tilted out of the water and cannot maintain a sonar signal.
- 3** Trailing edge [the edge farthest away from the boat].
- 4** Correctly aligned: the transducer side seam is parallel with the water line.
- 5** One click too low: the deeper the transducer is in the water, the more likely that a rooster tail of spray will be generated at high speeds. You also risk the transducer being struck and damaged by objects in the water, so make sure that the transducer is as high as it can be and still be submerged in the water.

- Continue to adjust until the transducer assembly until the bracket is also level from port to starboard [horizontally level as you look at the transducer from behind the boat] [see *Adjusting the Horizontal Transducer Angle*].

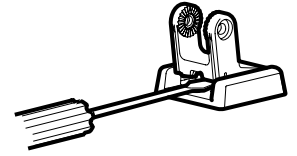

Mounting the Assembly to the Transom

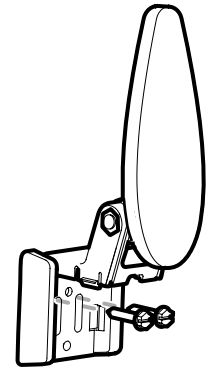

Adjusting the Transducer Mounting Position

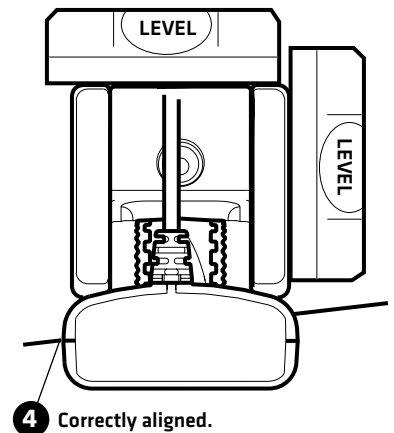

Adjusting the Horizontal Transducer Angle

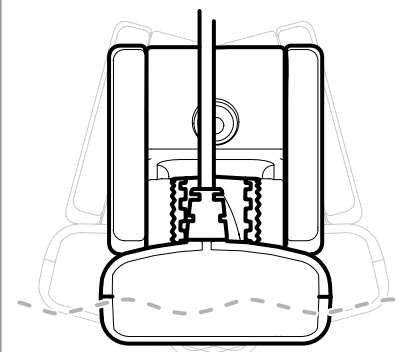

TRANSOM TRANSDUCER Installation Guide

532314-4_C

4. Once finalized, mark the correct position on the transom by tracing the silhouette of the transducer mounting bracket with a pencil or marker.
 5. Tighten the pivot bolt, using the pivot screw and nut to lock the assembly. **Hand-tighten only!**
- ⚠ CAUTION!** Do not use a high speed driver on this combination of fasteners. Hand-tighten only.
6. Snap open the assembly and hand-tighten the two mounting screws, then snap the assembly closed.

✍ NOTE: You will drill the third mounting hole and finalize the installation after you route the cable and test and finish the installation in the following procedures.

4 | Route the Cable

You can route the cable **over the transom** or **through a hole in the transom above the waterline**. Your boat may have a pre-existing wiring channel or conduit that you can use to route the cable. Select the routing method that is best for your boat configuration, and purchase any extension cables, cable clips, clamps, etc. as needed.

- It is best to route the cable to the side of the transducer so the transducer will not damage the cable during movement.
- The transducer can pivot up to 90 degrees in the bracket. Allow enough slack in the cable for this movement.
- **If you drill any holes, fill them with marine-grade silicone sealant.**
- **Excess Cable:** If there is excess cable that needs to be gathered at one location, dress the cable routed from both directions so that a single loop is left extending from the storage location. Doubling the cable up from this point, form the cable into a coil. Storing excess cable using this method can reduce electronic interference.

⚠ CAUTION! Do not cut or shorten the transducer cable, and try not to damage the cable insulation. Route the cable as far as possible from any VHF radio antenna cables or tachometer cables to reduce the possibility of interference. If the cable is too short, extension cables are available to extend the transducer cable up to a total of 50'. For assistance, contact Humminbird® Technical Support.

⚠ CAUTION! Do NOT mount the cables where the connectors could be submerged in water or flooded. If cables are installed in a splash-prone area, it may be helpful to apply dielectric grease to the inside of the connectors to prevent corrosion. Dielectric grease can be purchased separately from a general hardware or automotive store.

5 | Connect the Cable

1. Connect the transducer cable to the transducer port on the control head or cable connector (if applicable).

The connector is keyed to prevent reversed installation, and insertion should be easy. Do not force the connectors into the ports.

If the cable connector is round, hand-tighten the screw nut to secure the cable connection. **Hand-tighten only!**

Refer to your control head installation guide for additional details.

Routing the Cable

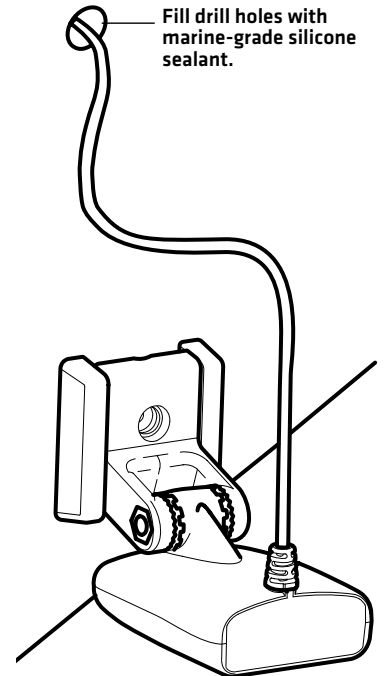

Transducer Connectors

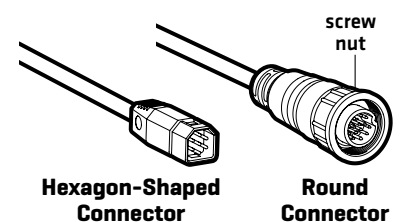

6 | Test and Finish the Installation

Once you have installed the control head, the transducer, and have routed all the cables, you must perform a final test before locking the transducer in place.

Testing should be performed with the boat in water deeper than 2 feet. The transducer should be fully submerged because the sonar signal cannot pass through air.

 **WARNING!** The transducer must be fully submerged in water during operation because the sonar signal cannot pass through air. Air pinging can damage the transducer.

Test the Transducer Installation on the Control Head

1. Press the POWER key to turn on the control head.

If the transducer is detected, the control head will start Normal mode.

2. Select a Sonar View to display on-screen.

HELIX®: Press and hold the VIEW key. Select Sonar > Sonar View.

APEX™/SOLIX®: Press the HOME key. Select a Sonar View.

Other: See your control head operations manual.

3. If the bottom is visible on-screen with a digital readout for Depth, the unit is working properly.

Gradually increase the boat speed to test high-speed performance. If the unit functions well at low speeds, but begins to skip or miss the bottom at higher speeds, the transducer requires adjustment.

 **NOTE:** Down Imaging provides the maximum detail at slower boat speeds, however high speed performance is available in the Down Imaging and traditional sonar views.

4. If you have the correct angle set on the transducer, yet lose a bottom reading at high speed, adjust the height and the running angle in small increments to give you the ideal transducer position for your boat. First, adjust the height in small increments.
5. **If you are still not getting good high speed readings,** you may need to disassemble the transducer mounting assembly and re-position the ratchets.

If you do change the transducer position, re-trace the position of the mounting bracket before proceeding.

 **NOTE:** It is often necessary to make several incremental transducer adjustments before optimum high speed performance is achieved. Due to the wide variety of boat hulls, however, it is not always possible to obtain high speed depth readings.

Finalize the Transducer Installation

Once you have reached a consistently good sonar signal at the desired speeds, you are ready to lock down the transducer settings.

6. Force the pivot to the Up position to gain access to the mounting screws, then re-align the mounting bracket against the transom of the boat to match the traced silhouette. Check the bracket position with the level again to make sure it is still level, then mark the third mounting hole using a pencil or marker.
7. Unscrew and remove the mounting screws and the transducer assembly and set aside.
8. Drill the third mounting hole, using a 5/32" [4 mm] drill bit.
9. Use a marine-grade silicone sealant to fill all three drilled mounting holes, especially if the holes penetrated the transom wall.
10. Re-position the transducer assembly against the transom of the boat, then hand-install all three screws. Make sure that the transducer location and the pivot angle have not changed, then fully tighten all three mounting screws. **Hand-tighten only!**
11. Snap the pivot back down. If you have performed the preceding procedures correctly, the transducer should be level and at the right height for optimal operation.

7 | Lock Down the Transducer (Optional)

 **NOTE:** You have the option to lock down the Two Piece Kick Up bracket if you do not want the transducer to kick up. Please be aware, however, that the transducer can be damaged if it is locked down and it strikes debris in the water.

1. To lock down the transducer, trace the position of the mounting bracket. Force the pivot to the Up position to gain access to the mounting screws, then re-align the mounting bracket against the transom of the boat to match the traced silhouette. Check the bracket position with the level again to make sure it is still level, then mark the fourth mounting hole using a pencil or marker [see **Using the Mounting Bracket to Mark the Initial Drill Holes**]. Unscrew and remove the mounting screws and the transducer assembly and set aside.
2. Drill the fourth mounting hole, using a 9/64" drill bit. Use a marine-grade silicone sealant to fill all four drilled mounting holes, especially if the holes penetrate the transom wall.
3. Re-position the transducer assembly against the transom of the boat, then hand install the first three screws [two on the outside edges and one in the 3rd mounting hole]. Make sure that the transducer location and the pivot angle have not changed, then fully tighten all three mounting screws [see **Fully Tightening All Three Mounting Screws**]. **Hand-tighten only!**
4. Snap the pivot back down. Install the #8 x 1" wood screw into the 4th hole to lock down the pivot arm. **Hand-tighten only!**

SETTING UP AN ACCESSORY TRANSDUCER ON THE CONTROL HEAD

The control head will automatically select the transducer that was included with your control head. If a compatible accessory transducer is connected, you will need to set the transducer type on the control head. When you select the transducer type, the related views and menus will be added to the system.

- For additional configuration information, download the control head operations manual from our Web site at humminbird.johnsonoutdoors.com.

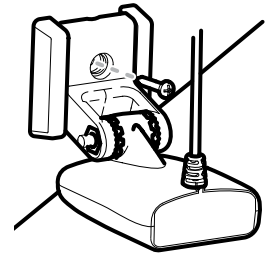
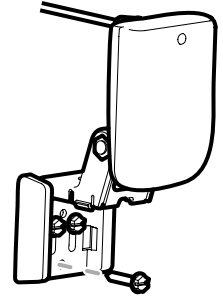
Fully Tightening All Three Mounting Screws

MAINTENANCE

If your transducer remains in the water for long periods of time, slush, algae and other marine growth can reduce the effectiveness of the transducer. Periodically clean the face of the transducer with a mild, marine-safe and plastic-safe soap or solution.

If your transducer remains out of the water for a long period of time, it may take some time to wet the transducer after it is returned to the water. Small air bubbles can cling to the surface of the transducer and interfere with proper operation. These bubbles will dissipate with time, or you may wipe the face of the transducer with your fingers after the transducer is in the water.

Contact Humminbird

Contact Humminbird Technical Support through our Help Center at <https://humminbird-help.johnsonoutdoors.com/hc/en-us> or in writing to the address below:

Humminbird Service Department
678 Humminbird Lane
Eufaula, AL 36027 USA



WARNING! Disassembly and repair of this electronic unit should only be performed by authorized service personnel. Any modification of the serial number or attempt to repair the original equipment or accessories by unauthorized individuals will void the warranty.



WARNING! The transducer must be fully submerged in water during operation because the sonar signal cannot pass through air. Air pinging can damage the transducer.



NOTE: Download Humminbird installation guides and operations manuals from our Web site at humminbird.johnsonoutdoors.com.



NOTE: Product specifications and features are subject to change without notice.

ENVIRONMENTAL COMPLIANCE STATEMENT: It is the intention of Johnson Outdoors Marine Electronics, Inc. to be a responsible corporate citizen, operating in compliance with known and applicable environmental regulations, and a good neighbor in the communities where we make or sell our products.

WEEE DIRECTIVE: EU Directive 2002/96/EC "Waste of Electrical and Electronic Equipment Directive (WEEE)" impacts most distributors, sellers, and manufacturers of consumer electronics in the European Union. The WEEE Directive requires the producer of consumer electronics to take responsibility for the management of waste from their products to achieve environmentally responsible disposal during the product life cycle.

WEEE compliance may not be required in your location for electrical & electronic equipment (EEE), nor may it be required for EEE designed and intended as fixed or temporary installation in transportation vehicles such as automobiles, aircraft, and boats. In some European Union member states, these vehicles are considered outside of the scope of the Directive, and EEE for those applications can be considered excluded from the WEEE Directive requirement.



This symbol [WEEE wheeled bin] on product indicates the product must not be disposed of with other household refuse. It must be disposed of and collected for recycling and recovery of waste EEE.

Johnson Outdoors Marine Electronics, Inc. will mark all EEE products in accordance with the WEEE Directive. It is our goal to comply in the collection, treatment, recovery, and environmentally sound disposal of those products; however, these requirements do vary within European Union member states. For more information about where you should dispose of your waste equipment for recycling and recovery and/or your European Union member state requirements, please contact your dealer or distributor from which your product was purchased.