

# MotorGuide®

**Operation  
Maintenance  
Installation  
Warranty  
Manual**

8M0130831

1117 eng



© 2017 Mercury Marine

**Xi3 Wireless Edition**



# ORIGINAL LANGUAGE INSTRUCTIONS

## FCC and IC Compliance Statement

Xi SERIES WIRELESS FOOT PEDAL FCC ID - MVU09291

Xi SERIES WIRELESS REMOTE FCC ID - MVU09305

IC: 6094A-09291, 6094A-09305

This device complies with part 15 of the FCC Rules. Operation is subject to the following two conditions:

1. This device may not cause harmful interference.
2. This device must accept any interference received including interference that may cause undesired operation.

This device complies with FCC Rules.

Changes or modifications not expressly approved by the party responsible for compliance could void the user's authority to operate the equipment.

This device complies with Industry Canada license-exempt RSS standard(s). Operation is subject to the following two conditions: (1) this device may not cause interference, and (2) this device must accept any interference, including interference that may cause undesired operation of the device.

Le présent appareil est conforme aux CNR d'Industrie Canada applicables aux appareils radio exempts de licence. L'exploitation est autorisée aux deux conditions suivantes: (1) l'appareil ne doit pas produire de brouillage, et (2) l'utilisateur de l'appareil doit accepter tout brouillage radioélectrique subi, même si le brouillage est susceptible d'en compromettre le fonctionnement.

## Simplified EU DoC

Hereby, Attwood Corporation declares that the radio equipment type, Xi3 Trolling Motor System, is in compliance with Directive 2014/53/EU. – The full text of the EU declaration of conformity is available at the following internet address: <http://www.motorguide.com/support/literature>

## Important Operator Information



**ISO 7000-0434B - Caution symbol**

**Consult this documentation in all cases where this symbol appears. This symbol is used to inform you of any potential HAZARD or actions that require your attention.**

**Use of this equipment in a manner other than that specified by Attwood Corporation may compromise the design integrity and become unsafe.**

**WARNING:** This equipment is not intended for use in explosive environments.

**ADVERTENCIA:** Este equipo no está diseñado para uso en atmósferas explosivas.

**AVVERTIMENTO:** Questa apparecchiatura non è intesa per l'uso in ambienti esplosivi.

**WARNING:** Das Ausrüstung darf in einer explosiven Umgebung NICHT verwendet werden.

**ADVERTISSEMENT:** Cet équipement n'est pas prévu pour une utilisation dans des environnements explosifs.

## Thank You

Thank you for purchasing a MotorGuide Xi3 Wireless Trolling Motor.

The Xi3 is designed and engineered to deliver the performance that anglers expect: quiet operation, reliability, and precise control. We're confident that the Xi3 will enhance your fishing experience and we appreciate that you chose MotorGuide.

Please take a moment to register your new Xi3 at [www.motorguide.com](http://www.motorguide.com)—or complete and mail the enclosed Warranty Registration Card.

## Warranty Message

The product you have purchased comes with a **Limited Warranty** from MotorGuide. The terms of the policy are set forth in the **Warranty Information** section of this manual. The policy statement contains a description of the duration of coverage, **important disclaimers and limitations of damages**, and other related information. Please review this important information.

The description and specifications contained herein were in effect at the time this manual was approved for printing. MotorGuide, whose policy is one of continued improvement, reserves the right to discontinue models at any time, to change specifications, designs, methods, or procedures without notice and without incurring obligation.

MotorGuide, Lowell, Michigan U.S.A.

Mercury Marine

Eagle and Lowrance are registered trademarks of Navico Inc. Garmin is a registered trademark of Garmin Ltd. Humminbird is a registered trademark of Johnson Outdoors Marine Electronics, Inc. Vexilar is a registered trademark of Vexilar, Inc.

## Copyright and Trademark Information

© **MERCURY MARINE. All rights reserved. Reproduction in whole or in part without permission is prohibited.**

Alpha, Axis, Bravo One, Bravo Two, Bravo Three, Circle M with Waves Logo, K-planes, Mariner, MerCathode, MerCruiser, Mercury, Mercury with Waves Logo, Mercury Marine, Mercury Precision Parts, Mercury Propellers, Mercury Racing, MotorGuide, OptiMax, Quicksilver, SeaCore, Skyhook, SmartCraft, Sport-Jet, Verado, VesselView, Zero Effort, Zeus, #1 On the Water and We're Driven to win are registered trademarks of Brunswick Corporation. Pro XS is a trademark of Brunswick Corporation. Mercury Product Protection is a registered service mark of Brunswick Corporation.

---

## Warranty Information

---

MotorGuide Two Year Limited Warranty.....	1
---	---

---

## General Information and Component Identification

---

Component Identification.....	4
Recording the Serial Number.....	5
Product Registration.....	5
Boater's Responsibilities.....	5
Protecting People in the Water.....	6
Passenger Safety Message.....	6
Safe Boating Suggestions.....	6

---

## Product Installation, Wiring, and Battery Information

---

Installing the Trolling Motor.....	8
Recommended Practice and Procedures.....	11
Battery Recommendations.....	11
Battery Precautions.....	12
Wire Color Code Abbreviations.....	13
Battery Connection.....	13
Wire and Cable Routing.....	15
Activating the Handheld Remote.....	15
Connecting the Sonar Display to the Trolling Motor.....	16
Reducing Sonar Transducer Interference.....	17

---

## Trolling Motor Operation

---

Status Indicator Light Identification.....	19
Stowing and Deploying the Trolling Motor.....	19
Adjusting the Motor Depth.....	23
Handheld Remote Operation.....	25

---

## Maintenance and Storage

---

Trolling Motor Care.....	27
Inspection and Maintenance Schedule.....	27
Storage Preparation.....	29
Battery Inspection.....	29
Corrosion Control Anode (Saltwater Models).....	29
Propeller Replacement.....	30

---

## Owner Service Assistance

---

Troubleshooting.....	33
Troubleshooting the Handheld Remote.....	36
Service Assistance.....	38
Mercury Marine Service Offices.....	38

# WARRANTY INFORMATION

## MotorGuide Two Year Limited Warranty

KEEP YOUR ORIGINAL PURCHASE RECEIPT OR BILL OF SALE.

1. For recreational use customers, MotorGuide electric trolling motors are warranted to the original retail purchaser to be free from defects in material or workmanship for a period of two years from the date of purchase.
2. To obtain warranty service, the purchaser should deliver or return the unit (postage prepaid and insured) to any MotorGuide authorized service dealer. **DO NOT RETURN TO PLACE OF PURCHASE** unless they are an authorized service center. Products returned by mail should be carefully packaged and include a note describing the nature of the problem and/or service requested, customer address, and phone number. A copy of the receipt, bill of sale, registration verification or other proof of purchase is required with the return of the product for warranty consideration. Warranty claims will not be accepted without presentation of purchase receipt for the trolling motor, other verification of registration, or bill of sale for a boat package.
3. MotorGuide, at its discretion, will repair or replace items covered under the terms of this warranty. Neither MotorGuide nor MotorGuide service dealers are responsible for damages to MotorGuide products due to repairs performed by anyone other than an authorized MotorGuide service dealer. Neither MotorGuide nor Attwood is responsible for failure or damage caused by improper installation, set-up, preparation, or previous service or repair errors.
4. For commercial use and government use customers, MotorGuide electric trolling motors are warranted to the original retail purchaser to be free from defects in material or workmanship for one (1) year. Commercial use is defined as any work or employment-related use of the product, or any use of the product which generates income, for any part of the warranty period, even if the product is only occasionally used for such purpose such as rental fleets, guides, fish camps or similar operations. Warranty is not transferable to any subsequent purchaser. The Mercury Product Protection plan is not available to commercial use or government use customers.
5. MotorGuide Composite Shaft Limited Lifetime Warranty. MotorGuide composite shafts are warranted to the original retail purchaser to be free of defects in material or workmanship for the lifetime of the original purchaser. MotorGuide will provide a new composite shaft at no cost for any composite shaft which contains a defect in material or workmanship. The installation costs are the sole responsibility of the purchaser.

# WARRANTY INFORMATION

6. Warranty coverage is available to customers that purchase from an authorized dealer or retailer that is authorized by MotorGuide Marine to distribute the product in the country in which the sale occurred. Warranty coverage and duration varies by the country in which the owner resides. This Limited Warranty begins on the date the product is first sold to a purchaser or the date on which the product is first put into service, whichever occurs first. MotorGuide accessories are covered by this Limited Warranty for a coverage period of one (1) year from the date of retail sale. The repair or replacement of parts, or the performance of service under this warranty, does not extend the life of this warranty beyond its original expiration date. Promotional warranties are not included in this statement and coverage may vary by promotion. Product either sold or put into service more than six years from date of manufacture is excluded from warranty coverage.
7. This warranty does not apply to normal worn parts, for example, worn cables, adjustments, or product damage due to: 1) neglect, lack of maintenance, accident, abnormal operation or improper installation or service; 2) abuse, such as, bent metal columns, bent armature shafts, broken control cables, etc., accidents, modifications, misuse, excessive wear or damage caused by an owner's failure to provide reasonable and necessary installation or care; 3) use of an accessory or part not manufactured by MotorGuide or Attwood; 4) alteration or removal of parts; 5) opening the lower unit (motor); 6) opening the transmission by anyone other than an authorized MotorGuide service center will void this warranty.
8. We reserve the right to improve the design of any trolling motor without assuming any obligation to modify any trolling motor previously manufactured.
9. All serialized "Service-Repair" trolling motors receive a (1) one year warranty. Non-serialized "Service-Repair" electric trolling motors are NOT warranted. "Service-Repair" motor denotes a trolling motor sold by MotorGuide that may be used, but has been inspected and may have had minor repairs. Original retail purchaser of a "Service-Repair" motor is the first purchaser of the motor after it is denoted as "Service-Repair." "Service-Repair" motors have a blue sticker on the battery cable and box denoting "Manufacturer Certified Service-Repair Motor."
10. This warranty will not apply to: 1) haul-out, launch, towing and storage, transportation charges and/or travel time, telephone or rental charges of any type, inconvenience, or loss of time or income, or other consequential damages; or 2) removal or replacement of boat partitions or material because of boat design for necessary access to the Product; or 3) disconnection and reconnection of hard-wired trolling motors.
11. **TERMINATION OF COVERAGE:** Warranty coverage may be terminated for repossessed product, or product purchased at auction, from a salvage yard, from a liquidator, from an insurance company, from unauthorized marine dealers or boatbuilders, or other third party entities.



## WARRANTY INFORMATION

12. ALL INCIDENTAL OR CONSEQUENTIAL DAMAGES ARE EXCLUDED FROM THIS WARRANTY, WARRANTIES OF MERCHANTABILITY AND FITNESS ARE EXCLUDED FROM THIS WARRANTY, IMPLIED WARRANTIES ARE LIMITED TO THE LIFE OF THIS WARRANTY. SOME STATES DO NOT ALLOW LIMITATIONS ON HOW LONG AN IMPLIED WARRANTY LASTS OR THE EXCLUSION OR LIMITATION OF INCIDENTAL OR CONSEQUENTIAL DAMAGES, SO THE ABOVE LIMITATIONS OR EXCLUSIONS MAY NOT APPLY TO YOU. THIS WARRANTY GIVES YOU SPECIFIC LEGAL RIGHTS, AND YOU MAY ALSO HAVE OTHER LEGAL RIGHTS WHICH MAY VARY FROM STATE TO STATE.

For Your Records:

Model Number \_\_\_\_\_

Serial Number \_\_\_\_\_

# GENERAL INFORMATION AND COMPONENT IDENTIFICATION

## Component Identification

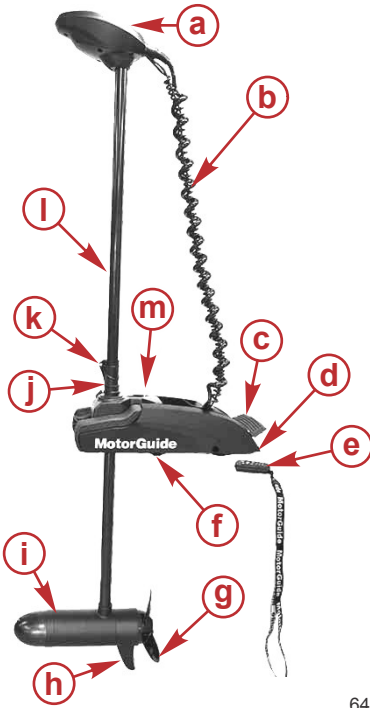

- a** - Head
- b** - Curly cable
- c** - Foot release lever
- d** - Battery cables (hidden)
- e** - Handheld wireless remote
- f** - Deck mount
- g** - Propeller
- h** - Skeg
- i** - Lower unit (motor)
- j** - Depth collar
- k** - Depth collar knob
- l** - Composite column
- m** - Steering transmission

64267

# GENERAL INFORMATION AND COMPONENT IDENTIFICATION

## Recording the Serial Number

It is important to record the serial number and model number for future reference. The serial number tags are located on the trolling motor as shown. Record the serial number and the model number in the space provided in the **Warranty Information** section of this manual.

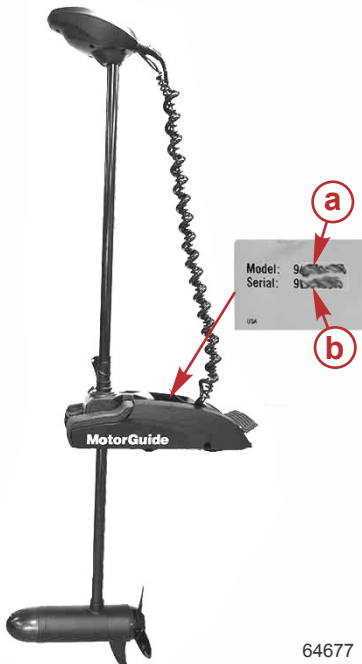

- a - Model identification number
- b - Serial number

64677

## Product Registration

For warranty purposes, please register your MotorGuide trolling motor by completing the enclosed warranty card or by visiting [www.motorguide.com](http://www.motorguide.com).

## Boater's Responsibilities

The operator (driver) is responsible for the correct and safe operation of the boat and safety of its occupants and general public. It is strongly recommended that each operator (driver) read and understand this entire manual before operating the trolling motor.

Be sure at least one additional person on board is instructed in the basic operation of the trolling motor in case the driver is unable to operate the boat.

# GENERAL INFORMATION AND COMPONENT IDENTIFICATION

## Protecting People in the Water

### WHILE YOU ARE TROLLING

It is difficult for a person in the water to take quick action to avoid a boat heading in their direction, even at slow speeds.



Always slow down and exercise extreme caution any time you are boating in an area where there might be people in the water.

### WHILE THE BOAT IS STATIONARY

#### ▲ WARNING

**A spinning propeller, a moving boat, or any solid device attached to the boat can cause serious injury or death to swimmers. Stop the trolling motor immediately whenever anyone in the water is near your boat.**

Unplug the trolling motor before allowing people to swim or be in the water near your boat.

## Passenger Safety Message

Whenever the boat is in motion, observe the location of all passengers. A sudden reduction in boat speed, such as a sharp change of boat direction, could throw them off the boat.

## Safe Boating Suggestions

In order to safely enjoy the waterways, familiarize yourself with local and other governmental boating regulations and restrictions, and consider the following suggestions.

**Use flotation devices.** It is the law to have an approved personal flotation device of suitable size for each person aboard and have it readily accessible.

**Do not overload your boat.** Most boats are rated and certified for maximum load (weight) capacities, refer to your boat capacity plate. If in doubt, contact your dealer or the boat's manufacturer.

**Perform safety checks and required maintenance.** Follow a regular schedule and ensure all repairs are made properly.

**Never be under the influence of alcohol or drugs while boating (it is the law).** Alcohol or drug use impairs your judgment and greatly reduces your ability to react quickly.

# GENERAL INFORMATION AND COMPONENT IDENTIFICATION

**Passenger boarding.** Stop the trolling motor whenever passengers are boarding or unloading.

**Be alert.** The operator of the boat is responsible by law to maintain a proper lookout by sight and hearing. The operator must have an unobstructed view particularly to the front. No passengers, load, or fishing seats should block the operators view when operating the boat.

**Underwater hazards.** Reduce speed and proceed with caution whenever navigating in shallow water.

**Tripping hazards.** To avoid a trip hazard, route all cables and wiring neatly and out of the way.

**Report accidents.** Boat operators are required by law to file a Boating Accident Report with their state boating law enforcement agency when their boat is involved in certain boating accidents. A boating accident must be reported if 1) there is loss of life or probable loss of life, 2) there is personal injury requiring medical treatment beyond first aid, 3) there is damage to boats or other property where the damage value exceeds \$500.00 or 4) there is complete loss of the boat. Seek further assistance from local law enforcement.

# PRODUCT INSTALLATION, WIRING, AND BATTERY INFORMATION

## Installing the Trolling Motor

1. Remove the side panel screw from each side of the deck mount. Gently pull the side panels away from the deck mount, taking care not to damage the locating tabs, and remove the side panels from both sides of the trolling motor.

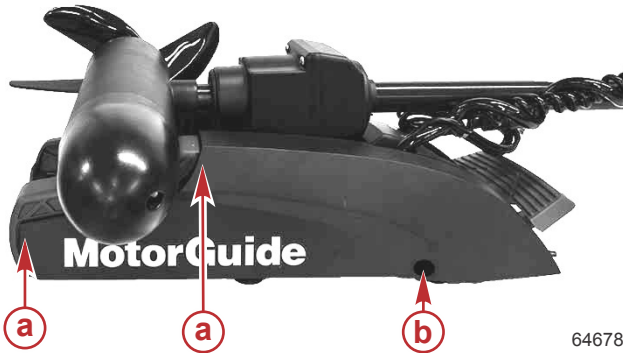

- a - Locating tabs
- b - Side panel screw

2. If you are replacing an existing MotorGuide or competitive brand trolling motor on your current boat, check if the existing mounting holes align with the new deck mount before drilling new holes. Ensure that the mounting location meets the requirements listed in **Step 4**.
3. If new holes are not required to mount the trolling motor, skip ahead to **Step 7**.
4. Carefully select an appropriate area on the deck of the boat close to the centerline to install the trolling motor. Ensure that the forward mounting bolts will not penetrate the hull. Have an assistant hold the trolling motor in position while the mounting location is being selected.

**IMPORTANT:** The mounting position must be tested in the stowed and deployed positions before drilling the mounting holes.

**IMPORTANT:** Ensure that the head does not protrude beyond the beam of the boat when in the stowed position.

# PRODUCT INSTALLATION, WIRING, AND BATTERY INFORMATION

**IMPORTANT:** A minimum clearance of 13 mm (0.5 in.) is required between the motor column and the rub rail on the boat when the trolling motor is deployed.

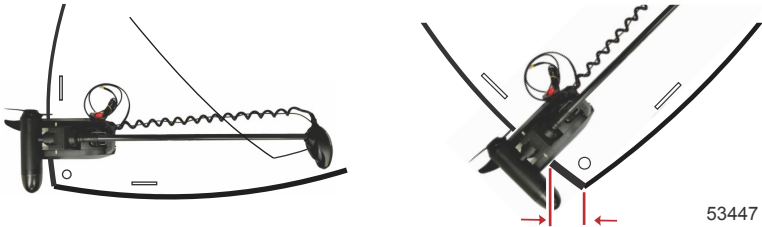

5. Place the trolling motor onto the deck of the boat at the selected location in the stowed position. Use the deck mounting bracket as a template and mark the location of the mounting holes.

**IMPORTANT:** Four mounting holes (two on each side) are required to securely mount the trolling motor. There are seven mounting hole positions to choose from on each side of the deck mounting bracket. Choose two hole positions on each side that work the best with your boat configuration.

**IMPORTANT:** Select mounting hole locations as far apart as practical on each side of the deck mounting bracket for the most secure mounting.

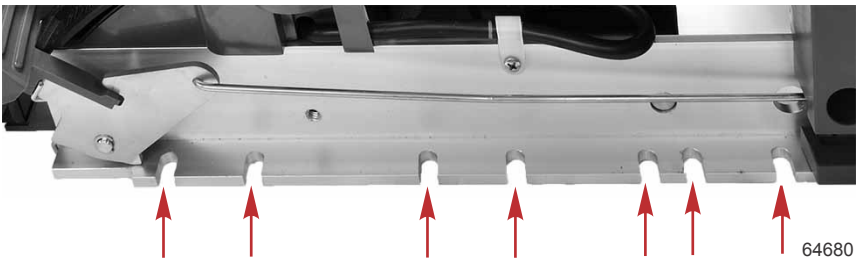

**Mounting hole locations—same on both sides**

6. Drill the mounting holes with a 8 mm (5/16 in.) drill bit. Remove any debris.

**IMPORTANT:** To help prevent cracking on fiberglass decks, use a countersink bit or a larger drill bit to countersink the mounting holes.

7. Align the deck mounting bracket to the holes in the deck. On fiberglass boats with no carpet where the motor is being installed, install the rubber isolators between the boat deck and the deck mounting bracket. Install three stainless steel mounting bolts through the mounting holes on one side of the deck mounting bracket. Install a washer and a nylock nut onto each bolt, but do not tighten them at this time.

# PRODUCT INSTALLATION, WIRING, AND BATTERY INFORMATION

**NOTE:** If the trolling motor is being mounted to a carpeted boat deck, the rubber isolators are not required.

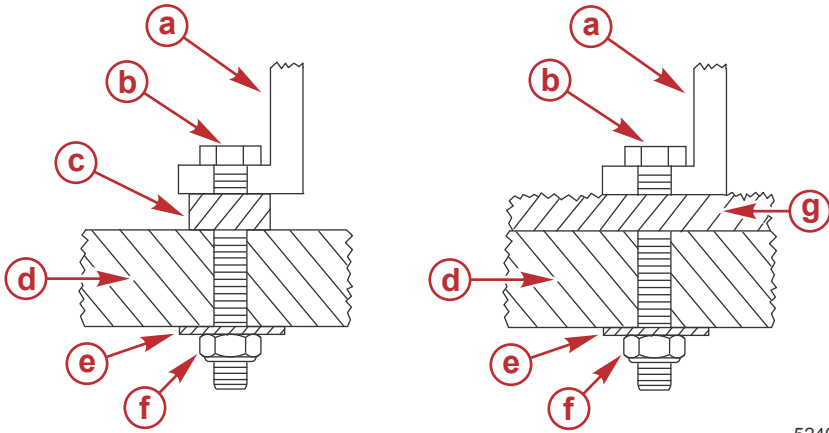

52406

- a** - Deck mounting bracket
- b** - Mounting bolt
- c** - Rubber isolator
- d** - Deck
- e** - Washer
- f** - Stainless steel nylock nut
- g** - Carpet

8. Align the trolling motor with the mounting holes in the deck. Hold the mounting screws securely with a 7/16 in. wrench while using a wrench or socket to tighten the nylock nuts on both sides of the deck mounting bracket from under the deck.



# PRODUCT INSTALLATION, WIRING, AND BATTERY INFORMATION

9. Install the side panels (deckets) onto the trolling motor by inserting the tabbed end into the lower unit cradle bracket slot, taking care not to damage the locating tabs. Install the side panel screw.

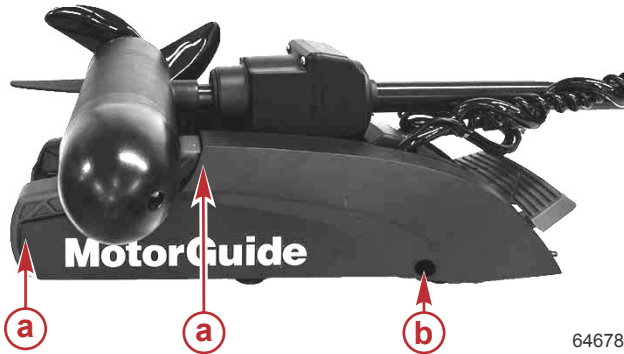

64678

- a** - Locating tabs
- b** - Side panel screw

## Recommended Practice and Procedures

**IMPORTANT:** Unplug the trolling motor after each use and when charging the battery.

- Do not use the main engine battery to power the trolling motor. Use a dedicated trolling motor battery or battery bank.
- Ensure that the batteries are enclosed and secured within a battery box to prevent accidental shorting of the battery terminals.
- Route the trolling motor wires on the opposite side of the boat from other boat wiring.
- Ensure the positive and negative wires are bound to each other.
- Connect boat accessories directly to the main engine battery.
- Do not charge the trolling motor batteries while the trolling motor is in the deployed (down) position.

## Battery Recommendations

- Use 12-volt, deep cycle marine batteries. The number of batteries required varies according to the model of your trolling motor. Refer to **Battery Connection**.
- As a general rule, deep cycle batteries with a higher amp-hour rating or reserve capacity rating will provide longer run times and better performance.
- Install a manual reset circuit breaker in line with the trolling motor positive leads within 1.8 m (6 ft) of the batteries. These can be purchased from your local MotorGuide retailer or from [www.motorguide.com](http://www.motorguide.com).

# PRODUCT INSTALLATION, WIRING, AND BATTERY INFORMATION

- Do not extend the included 10-gauge battery cables more than 1.8 m (6 ft) for a total of 3 m (10 ft). If longer battery cables are required, MotorGuide offers accessory 8 mm<sup>2</sup> (8-gauge) battery cables.
- Use stainless steel nylock nuts to secure the battery cables to their terminals. Using stainless steel wing nuts to secure the battery cables can cause loose connections.
- Do not power any depth sounders or fish finders from the trolling motor battery. Connecting electronic equipment to the trolling motor batteries can cause electrical interference. Any depth sounders or fish finders must be powered from the engine starting or accessory battery.

Recommended MotorGuide Accessory Description
8-gauge battery cable and terminals with 50-amp manual reset circuit breaker
50-amp manual reset circuit breaker
60-amp manual reset circuit breaker

## Battery Precautions

### WARNING

**An operating or charging battery produces gas that can ignite and explode, spraying out sulfuric acid, which can cause severe burns. Ventilate the area around the battery and wear protective equipment when handling or servicing batteries.**

When charging batteries, an explosive gas mixture forms in each cell. Part of this gas escapes through holes in the vent plugs and may form an explosive atmosphere around the battery if ventilation is poor. This explosive gas may remain in or around the battery for several hours after it has been charged. Sparks or flames can ignite this gas and cause an internal explosion, which may shatter the battery.

The following precautions should be observed to prevent an explosion:

1. Keep flames away and do not smoke near batteries being charged or which have been charged recently.
2. Do not disconnect the battery cables while the trolling motor is operating, because a spark usually occurs at the point where a live circuit is broken. Always use care to prevent reverse polarization when connecting or disconnecting cable clamps on chargers. Poor connections are a common cause of electrical arcs, which cause explosions.
3. Do not reverse the polarity of battery terminal to cable connections.

# PRODUCT INSTALLATION, WIRING, AND BATTERY INFORMATION

## Wire Color Code Abbreviations

Wire Color Abbreviations				
BLK	Black		BLU	Blue
BRN	Brown		GRY or GRA	Gray
GRN	Green		ORN or ORG	Orange
PNK	Pink		PPL or PUR	Purple
RED	Red		TAN	Tan
WHT	White		YEL	Yellow
LT or LIT	Light		DK or DRK	Dark

## Battery Connection

### ⚠ WARNING

Before working around electrical system components, disconnect the battery cables from the battery to prevent injury or damage to the electrical system due to an accidental short circuit.

### ⚠ CAUTION

Disconnecting or connecting the battery cables in the incorrect order can cause injury from electrical shock or can damage the electrical system. Always disconnect the negative (-) battery cable first and connect it last.

### NOTICE

Failure to operate the trolling motor within the recommended voltage specifications can cause product damage. Do not exceed the maximum supply voltage.

**IMPORTANT:** Refer to the decal on the head of the trolling motor to determine the voltage requirements of your trolling motor.

## 12-VOLT BATTERY CONNECTION

1. Install a 50-amp (good) or 60-amp (best) manual reset circuit breaker in line with the trolling motor power cable positive (+) lead and the trolling motor battery positive (+) terminal.
2. Connect the positive (+) trolling motor lead to the positive (+) trolling motor battery terminal.

# PRODUCT INSTALLATION, WIRING, AND BATTERY INFORMATION

3. Connect the negative (-) trolling motor lead to the negative (-) trolling motor battery terminal.

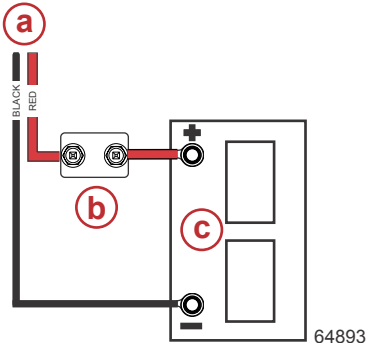

## 12-volt battery connection

- a - Power cables to trolling motor
- b - Manual reset circuit breaker
- c - Trolling motor battery

## 24-VOLT BATTERY CONNECTION

1. Install a 50-amp (good) or 60-amp (best) manual reset circuit breaker in line with the trolling motor power cable positive (+) lead and the trolling motor battery **B** positive (+) terminal.
2. Connect the positive (+) trolling motor lead to the positive (+) terminal on trolling motor battery **B**.
3. Connect a jumper wire (reference gray) between the negative (-) terminal on battery **B** to the positive (+) terminal on battery **A**.

**IMPORTANT: The jumper wire should be the same wire gauge as the negative (-) and positive (+) power cables.**

4. Connect the trolling motor negative (-) lead to the negative (-) terminal on battery **A**.

# PRODUCT INSTALLATION, WIRING, AND BATTERY INFORMATION

- Starting with the positive (+) lead, reconnect the battery cables to the engine starting or accessory battery.

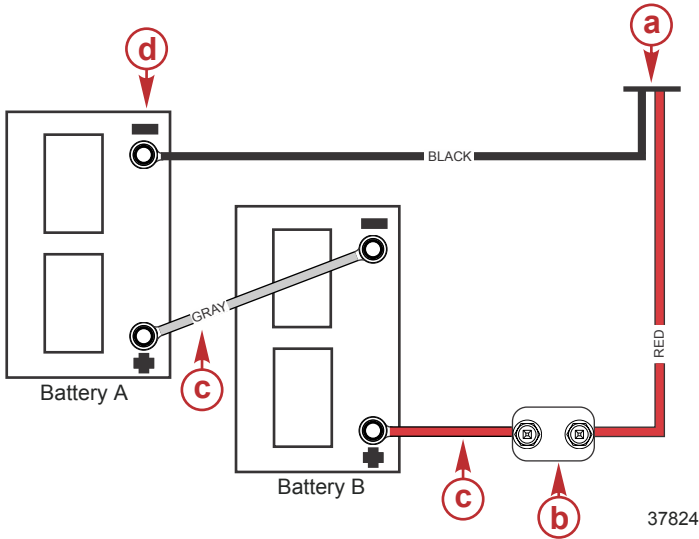

## 24-volt battery connection

- a** - Power cables to trolling motor
- b** - Manual reset circuit breaker
- c** - Jumper wire (not supplied)
- d** - Negative (-) battery terminal

## Wire and Cable Routing

- Route the trolling motor wires on the opposite side of the boat from other boat wiring.
- The trolling motor should be connected to its own dedicated battery.
- Sensitive electronics, such as depth finders, must be connected to a separate battery.
- Marine engines should have their own dedicated starting battery.

## Activating the Handheld Remote

- If the trolling motor power cables are connected, disconnect the power cables from the trolling motor battery, starting with the negative (-) lead.
- Deploy the motor, then connect the power cables to the battery or plug in the power cable to a battery source. Within ten seconds of connecting the power cables, press and hold the **left** and **right arrow** buttons on the handheld remote simultaneously.

# PRODUCT INSTALLATION, WIRING, AND BATTERY INFORMATION

- Listen for a multitone beep, which indicates that the receiver has stored the electronic serial number.

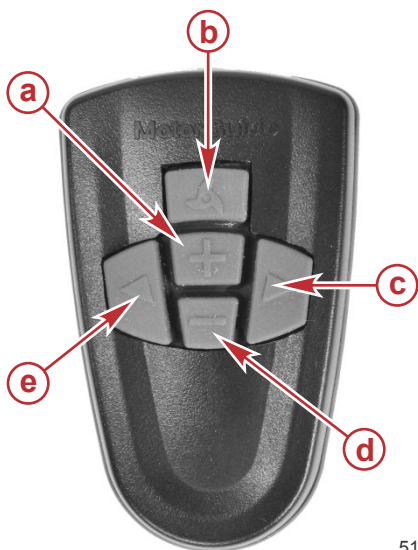

- a** - + button—increase speed
- b** - **Propeller** button—propeller on/off
- c** - **Right arrow** button—steer right
- d** - - button—decrease speed
- e** - **Left arrow** button—steer left

51842

If you are having trouble syncing your remote, start with the motor unplugged and deployed. Hold down the **left arrow** and **right arrow** buttons at the same time before you plug in the motor.

## Connecting the Sonar Display to the Trolling Motor

**NOTE:** This procedure applies only to models equipped with integrated sonar.

This sonar display connection procedure applies to trolling motor models with internal sonar that offer built-in 200/83 kHz sonar transducers compatible with Eagle®, Garmin™, Humminbird™, Lowrance™, and Vexilar® brand sonar displays. For compatibility with other sonar units, refer to [www.motorguide.com](http://www.motorguide.com).

# PRODUCT INSTALLATION, WIRING, AND BATTERY INFORMATION

The trolling motor is equipped with a Lowrance 7-pin plug. Adapters are available to connect other brands of sonar displays to the trolling motor. Match the cable connector to the sonar port on the back of the sonar display. Power up the unit to ensure that the sonar cable is connected securely.

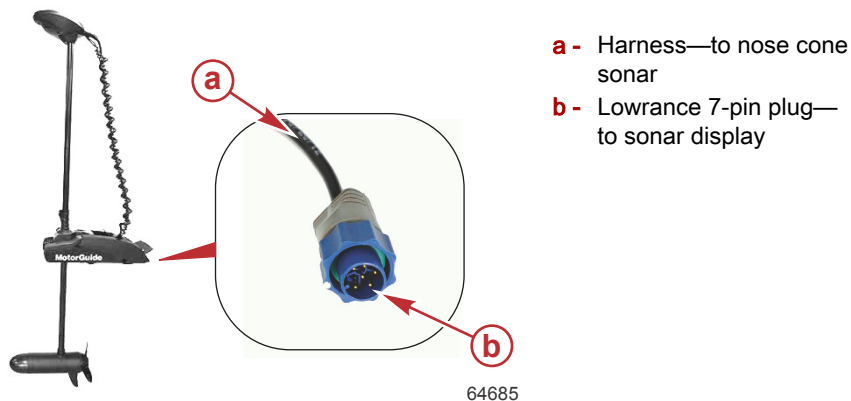

## Transducer Adapter Cables Available from MotorGuide

Lowrance 7-to-6-pin adapter

Vexilar 3-pin adapter

Garmin 6-pin adapter

Humminbird 7-pin adapter

## Reducing Sonar Transducer Interference

The following items should be checked, in order, to help improve sonar performance. Keep in mind, all sonar testing should be done on the water in stable conditions.

1. Ensure you have separate grounds/no common ground between trolling motor battery bank (12V, 24V, 36V) and engine/accessory battery bank (12V).
2. Keep trolling motor power cables and sonar/electronics cables as far apart as possible on the boat. (Example: Trolling motor cables routed on the port side and electronics cables routed on the starboard side).
3. A multi-bank charger that is connected to both the trolling motor bank and engine/accessory battery bank can cause interference through the common ground in the charger.
4. Ensure that none of your sonar cables are cut or damaged. Even internally broken shielding can cause issues and can be identified by carefully inspecting the rubberized outer coating for crimps, bends, and flattened areas. Repair/replace as necessary.
5. Check for common external sources of interference and temporarily remove or disable these to test for improvements in sonar performance. These include:

# PRODUCT INSTALLATION, WIRING, AND BATTERY INFORMATION

- a. Ethernet links
  - b. Multiple sonar transducers operating on same frequencies
  - c. Other 3rd party electronic equipment
6. Ferrite rings/chokes may have some positive effect on sonar performance. Ensure you have the correct size for the gauge wire you are installing on.
  7. If sonar performance has still not improved, check with MFD/Electronics manufacturers or your boat dealer to check for other boat wiring issues.



# TROLLING MOTOR OPERATION

## Status Indicator Light Identification

This trolling motor is equipped with a multifunction status indicator light panel. It can display the on/off status of the motor, propeller, battery charge, and GPS status for quick and easy reference during operation.

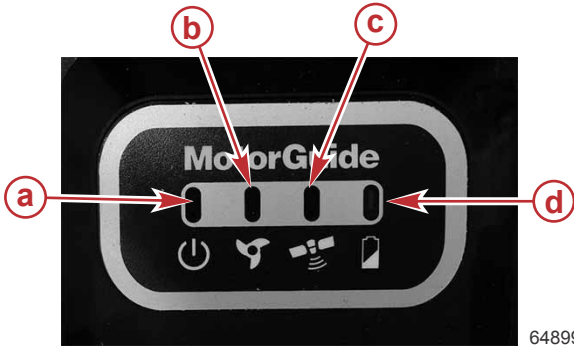

- a** - Power on/off/sleep indicator light
- b** - Propeller on/off indicator light
- c** - GPS navigation indicator light
- d** - Battery status light

Battery Status Light Color Code	
Color	Capacity
Green	greater than 30%
Red	less than 30%
Flashing red	less than 10%

## Stowing and Deploying the Trolling Motor

### ⚠ WARNING

Rotating propellers can cause serious injury or death. Never start or operate the motor out of water.

### ⚠ CAUTION

Moving parts, such as hinges and pivot points, can cause serious injury. Keep away from moving parts when stowing, deploying, or tilting the motor.

## STOWING THE TROLLING MOTOR

1. Ensure the propeller is not running.
2. Ensure there is sufficient clearance around the trolling motor before rotating the motor into stowed position.

# TROLLING MOTOR OPERATION

3. Press down on the foot release lever with one hand or foot. While pressing down on the foot release lever, pull and tilt the trolling motor towards the mount.



**a** - Foot release lever

64686

# TROLLING MOTOR OPERATION

4. Raise the motor out of the water and rotate the transmission so the lower unit is aligned with the mount cradle. Orient the lower unit so the cable does not wrap around the trolling motor column. Slide the lower unit into the mount cradle until the lower unit is fully seated. The mount will lock the trolling motor in the stowed position. If GPS equipped, it is common to lose the GPS signal while stowed.

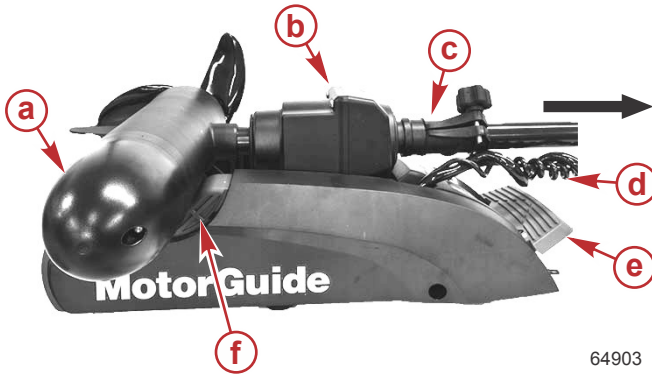

- a - Lower unit (motor)
- b - Transmission
- c - Depth collar
- d - Curly cable
- e - Foot release lever
- f - Mount cradle

5. Slide the depth collar so it is tight against the steering transmission. Rotate the depth collar until it engages the steering transmission, then tighten the depth collar knob.

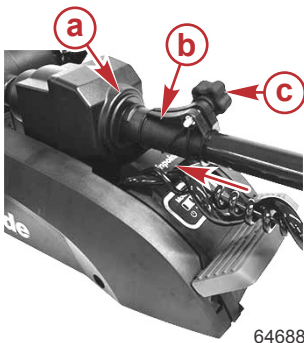

- a - Steering transmission
- b - Depth collar
- c - Depth collar knob

**IMPORTANT:** Trolling motor can unintentionally deploy if not fully secured. Ensure the depth collar is fully seated with transmission and the depth collar knob is tight any time the boat is underway or trailered.

# TROLLING MOTOR OPERATION

**IMPORTANT:** Optional column mount stabilizers are available for supporting the trolling motor column in extremely rough boating conditions.

Recommended MotorGuide Accessory Description
Standard Ram® mount stabilizer
Long Ram® mount stabilizer

## DEPLOYING THE TROLLING MOTOR

1. Loosen the depth collar knob, then slide the depth collar away from the steering transmission. Tighten the depth collar knob by turning the knob clockwise.
2. Press down on the foot release lever with one hand or one foot. Firmly grasp the column and slide the lower unit away from the mount cradle. Release the foot lever.

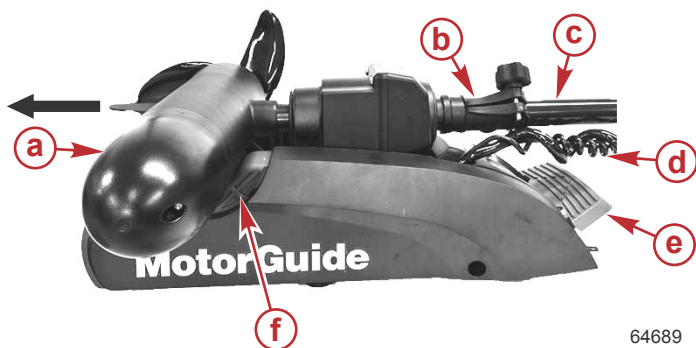

- a** - Lower unit (motor)
- b** - Depth collar
- c** - Column
- d** - Curly cable
- e** - Foot release lever
- f** - Mount cradle

3. Ensure there is sufficient clearance around the area where the trolling motor will be deployed.

# TROLLING MOTOR OPERATION

4. Tilt the motor out of the stowed position and lower the trolling motor until the depth collar rests on top of the steering housing collar. Rotate the trolling motor so the depth collar locks into position on the steering housing collar. The motor will lock into the deployed position. Pull back on the column to ensure that it is securely locked into the deployed position.



## Adjusting the Motor Depth

### ⚠ CAUTION

Avoid injury due to the sudden shifting of weight when deploying the motor or adjusting the motor depth. When raising or lowering the motor, firmly grasp the motor column with one hand before loosening the depth collar knob.

Adjust the depth of the motor to improve the trolling motor performance in various water depths.

# TROLLING MOTOR OPERATION

**IMPORTANT:** Do not use the curly cable as a handle when raising or lowering the motor.

When adjusting the motor depth, ensure that the lower unit is fully submerged a minimum of 30 cm (12 in.) to avoid propeller ventilation. Optimal depth of the lower unit will vary depending on the boat type, water conditions, and the underwater terrain. If you hear the propeller blades splashing against the water surface, lower the motor depth.

1. Ensure the propeller is not running before adjusting the depth of the motor.
2. Firmly grasp the column with one hand and turn the depth collar knob counterclockwise so the column moves freely.

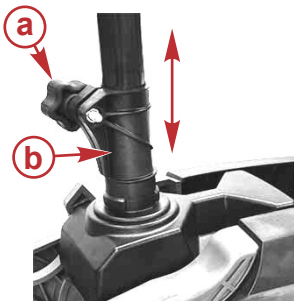

- a - Depth collar knob
- b - Depth collar

64905

3. Raise or lower the column to the desired depth. Align the depth collar to the key slot on top of the transmission. Tighten the depth collar knob to secure the column.

# TROLLING MOTOR OPERATION

## Handheld Remote Operation

### ⚠ WARNING

Rotating propellers can cause serious injury or death. Never start or operate the motor out of water.

To operate the trolling motor using the handheld remote, sync the foot pedal to the trolling motor receiver. Refer to **Activating the Handheld Remote** in the **Product Installation, Wiring, and Battery Information** section of this manual.

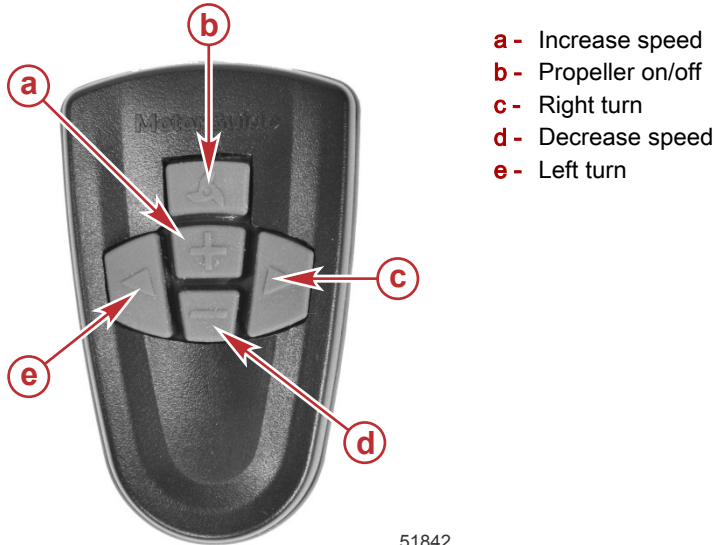

## TURNING THE HANDHELD REMOTE ON OR OFF

The handheld remote is always on, and is ready for use anytime that the trolling motor is powered up and in the deployed position.

## SLEEP MODE

- When the trolling motor is not in an active state and idle for more than three minutes, it will automatically enter Sleep mode, a low power state, such as:
  - a. The propeller is not running.
  - b. The propeller is at zero speed.
  - c. No GPS mode is active.
- The Sleep Mode state is indicated by the power LED slowly fading on and off.

# TROLLING MOTOR OPERATION

- The Sleep Mode state can start when the trolling motor is in the stowed or deployed position.
- Wake the trolling motor from Sleep Mode by pressing any button on the FOB or wireless foot pedal (sold separately).
- The next button pressed will activate the trolling motor and perform the intended button function. Once the motor is activated all the functions will operate normally.

## STEERING

- To turn left, press the **left turn** button on the handheld remote.
- To turn right, press the **right turn** button on the handheld remote.
- The available steering range allows the trolling motor to turn beyond 360° for operation in reverse. Take care not to stress the cables when rotating the trolling motor beyond 360°.

## SPEED CONTROL

- Press the **propeller on/off** button once to start the propeller, and press the **propeller on/off** button again to stop the propeller.
- The trolling motor will emit a single ascending-tone beep when the **propeller** is turned on and a single descending-tone beep when the **propeller** is turned off.
- The system is equipped with 20 speed levels. Press and release the **increase speed (+)** button to increase motor speed by one level. Press and release the **decrease speed (-)** button to reduce motor speed by one level.
- Holding the **increase speed (+)** or **decrease speed (-)** will cause the speed level to increase or decrease until the speed level limit is reached. Holding the **increase speed (+)** or **decrease speed (-)** button for 2.5 seconds will ramp up the speed level from 0% to 100%, or decrease from 100% to 0%, respectively. The trolling motor will emit two beeps when it reaches the 100% or 0% speed level.



# MAINTENANCE AND STORAGE

## Trolling Motor Care

To keep your trolling motor in the best operating condition and retain its dependability, your trolling motor must receive periodic inspections and maintenance. Keep it maintained properly to ensure the safety of you and your passengers.

### WARNING

**Neglecting to inspect, maintain, or repair your trolling motor can result in product damage or serious injury or death. Do not perform maintenance or service on your trolling motor if you are not familiar with the correct service and safety procedures.**

Record all maintenance performed and save maintenance work orders and receipts.

## SELECTING REPLACEMENT PARTS

Use only original MotorGuide replacement parts.

## Inspection and Maintenance Schedule

### BEFORE EACH USE

- Inspect for loose or corroded wiring connections.
- Check the tightness of the battery cable connections. Nylock nuts are recommended for securing the battery cables to their terminals.
- Check the tightness of the propeller nut.
- Check the propeller blades for damage.
- Check the tightness of the mount to the deck of the boat.

### AFTER EACH USE

- Disconnect the battery cables from the power source, or unplug the motor from the boat or open the installed breaker.
- Check each side of the propeller and propeller shaft for debris such as weeds and fishing line. Remove all debris.
- Check the tightness of the propeller nut.
- Wash the trolling motor with clean water and a mild soap such as Attwood® Premium Boat Wash to remove dirt and dust that may scratch the surface.

**IMPORTANT: Do not use harsh cleaners such as bleach or citrus cleaners to clean the trolling motor. These cleaners can damage the finish on the trolling motor.**

**IMPORTANT: Do not power wash the trolling motor.**

### EVERY 100 HOURS OF USE OR ANNUALLY (WHICHEVER OCCURS FIRST)

1. Apply 2-4-C with PTFE to the depth collar knob screw threads.

# MAINTENANCE AND STORAGE

**NOTE:** 2-4-C with PTFE is a marine grease available at marine supply stores and your MotorGuide dealer.

Tube Ref No.	Description	Where Used	Part No.
 95	2-4-C with PTFE	Depth collar knob screw threads	92-802859A 1

- Remove the side panels by removing the screw on each side of the mount. Gently pull the cover away from the mount and towards the foot release lever.

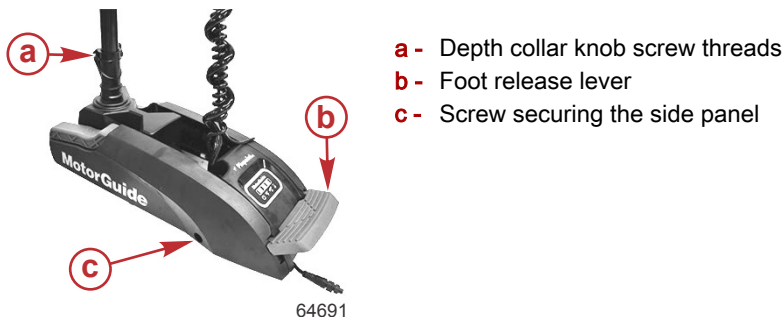

- a - Depth collar knob screw threads
- b - Foot release lever
- c - Screw securing the side panel

- Apply 2-4-C with PTFE to the release wire at the foot pedal pivot pin and the release wire on the release pin.



- a - Foot pedal pivot pin
- b - Release pin

Tube Ref No.	Description	Where Used	Part No.
 95	2-4-C with PTFE	Release wire at the foot pedal pivot pin and the release wire on the release pin	92-802859A 1

# MAINTENANCE AND STORAGE

## Storage Preparation

The major consideration in preparing your trolling motor for storage is to protect it from corrosion and damage caused by freezing of trapped water. It is also recommended that batteries are disconnected prior to storage and that the batteries are stored indoors in a dry location during long-term storage. The batteries should also be removed from the handheld remote and wireless foot pedal for long-term storage.

Refer to the **Inspection and Maintenance Schedule** and complete the appropriate care instructions to prepare your trolling motor for storage. Store the trolling motor in a dry location where it will not be affected by temperatures below  $-29\text{ }^{\circ}\text{C}$  ( $-20\text{ }^{\circ}\text{F}$ ).

**IMPORTANT: Trolling motors stored in temperatures below  $0\text{ }^{\circ}\text{C}$  ( $32\text{ }^{\circ}\text{F}$ ) should be operated slowly for a minimum of 15 minutes before going above 30% throttle.**

## Battery Inspection

The battery should be inspected at periodic intervals to ensure proper trolling motor operation.

**IMPORTANT: Read the safety and maintenance instructions that accompany your battery.**

1. Ensure that the battery is secured to the vessel.
2. Ensure that the battery cable terminals are clean, tight, and correctly installed. For installation instructions, refer to **Battery Connection** in the **Product Installation, Wiring, and Battery Information** section of this manual.
3. Ensure that the battery is equipped with a battery box to prevent accidental shorting of the battery terminals.

## Corrosion Control Anode (Saltwater Models)

The anode helps protect the trolling motor against galvanic corrosion by sacrificing its metal to be slowly eroded instead of the trolling motor metal components. The anode requires periodic inspection, especially in saltwater which will accelerate the erosion. To maintain this corrosion protection, replace the anode if it is more than 50% eroded. Never paint or apply a protective coating to the anode as this will reduce effectiveness of the anode.

# MAINTENANCE AND STORAGE

**IMPORTANT:** Do not paint the anode or clean it with steel wool, sandpaper, wire brushes, or other abrasive materials. Replace the anode if it is more than 50% eroded.

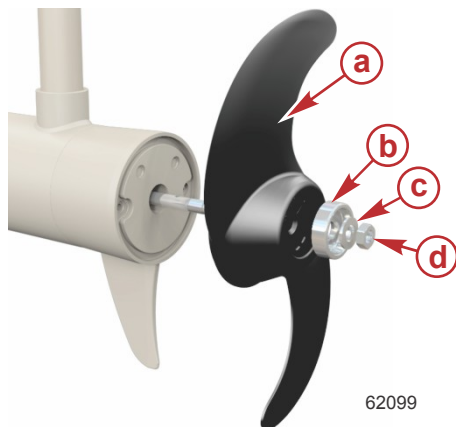

- a - Propeller
- b - Anode (saltwater models only)
- c - Washer
- d - Propeller nut

## Propeller Replacement

### ⚠ WARNING

Performing service or maintenance without first disconnecting the battery can cause product damage, personal injury, or death due to fire, explosion, electrical shock, or unexpected motor starting. Always disconnect the battery cables from the battery before maintaining, servicing, installing, or removing motor components.

## REMOVING THE PROPELLER

1. Disconnect the power cables from the battery.
2. While holding the propeller blade with one gloved hand, use a 9/16 in. wrench or a ratchet to remove the propeller nut. Remove the propeller nut and washer (or anode, for saltwater models).

**IMPORTANT:** Remove the propeller nut with a wrench or a ratchet and socket. Using another tool may damage the propeller nut or shaft. If the propeller cannot be removed easily, use a rubber mallet to lightly tap the back side of the opposite blade. If the propeller cannot be removed, have the propeller removed by an authorized dealer.

# MAINTENANCE AND STORAGE

**NOTE:** Replace the propeller pin if it is bent.



## INSTALLING THE PROPELLER

1. Rotate the motor shaft to insert the propeller pin horizontally.

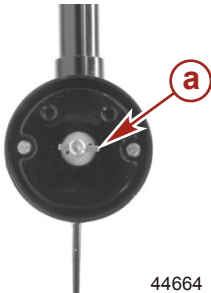

**a** - Propeller pin

2. Install the propeller onto the motor shaft by engaging the propeller onto the propeller pin.
3. Install the washer (and anode, for saltwater models) onto the propeller shaft, then install the propeller nut. Use a wrench or a socket and ratchet to tighten the propeller nut until it is snug, then tighten the nut another 1/4 turn.

# MAINTENANCE AND STORAGE

**IMPORTANT:** Do not overtighten the propeller nut, or damage to the propeller or propeller pin may occur.

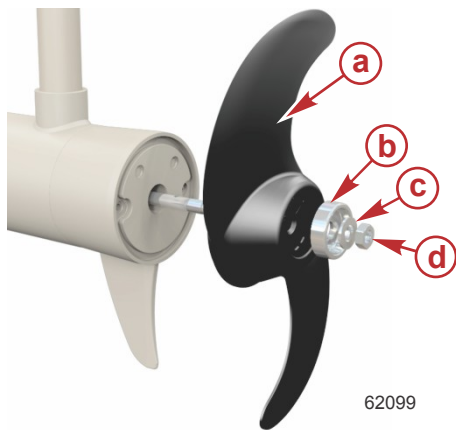

## Saltwater model shown

- a** - Propeller
- b** - Anode (saltwater models only)
- c** - Washer
- d** - Propeller nut

62099

# OWNER SERVICE ASSISTANCE

## Troubleshooting

**NOTE:** For service information, contact any certified MotorGuide service center. For a full listing of MotorGuide service centers, go to [www.motorguide.com](http://www.motorguide.com) or contact any Mercury Marine service office.

Symptom	Possible Cause	Resolution
Trolling motor does not respond to wireless commands	Weak trolling motor batteries	Check the battery charge indicator on the trolling motor. Recharge or replace batteries as required.
	Weak handheld remote battery or weak foot pedal battery	Replace the handheld remote battery or foot pedal batteries.
	Wireless controllers not synced	Refer to <b>Activating the Wireless Foot Pedal</b> or <b>Activating the Handheld Remote</b> .
Loss of power	Weak trolling motor batteries	Check the battery charge indicator on the trolling motor. Recharge or replace the batteries as required.
	Loose or corroded battery connections	Inspect battery connections for cleanliness and tightness.
	Propeller is loose, damaged, or off-balance	Refer to <b>Propeller Replacement</b> .
	Wiring or electrical connection faulty	Wire gauge from the battery to the trolling motor is insufficient. 6-gauge wire is recommended.
	Magnets cracked or chipped	The motor will whine or grind. Contact a Service Center.
	Water intrusion in the lower unit	Contact a Service Center.

# OWNER SERVICE ASSISTANCE

Symptom	Possible Cause	Resolution
Excessive noise or vibration	Propeller is loose, damaged, or off-balance	Refer to <b>Propeller Replacement</b> .
	Damaged bearings or bushings	Contact a Service Center.
	Magnets interfering with armature	Turn off the power and manually rotate the propeller. If the propeller does not rotate freely with a slight magnetic drag, contact a Service Center.
	Magnets cracked or chipped	The motor will whine or grind. Contact a Service Center.
Motor failure (motor runs at partial speed)	Loose electrical connections	Connections in the head may be loose or damaged. Contact a Service Center.
	Motor has reached thermal limit	Temperature exceeds specification. Contact a Service Center.
	Propeller is loose, damaged, or off-balance	Refer to <b>Propeller Replacement</b> .
Trolling motor flashes the propeller LED and battery LED while emitting a siren noise	Internal electronics fault	Disconnect battery power. Contact a Service Center.



# OWNER SERVICE ASSISTANCE

Symptom	Possible Cause	Resolution	
Motor failure (motor does not run)	Weak trolling motor batteries	Check the battery charge indicator on the trolling motor. Recharge or replace the battery as required.	
	Batteries in the foot pedal or handheld remote need replacement	Refer to <b>Troubleshooting the Foot Pedal and Handheld Remote</b> .	
	Loose or corroded battery connections	Inspect battery connections for cleanliness and tightness.	
	Wiring or electrical connection faulty	Wire gauge from the battery to the trolling motor is insufficient. 6-gauge wire is recommended.	
	Loose electrical connections	Inspect connections for cleanliness and tightness.	
	Thermal protection is overloaded		Disconnect the trolling motor batteries and check for weeds or debris around the propeller.
			Temperature exceeds specification. Contact a Service Center.
	Fuse or circuit breaker is open	Replace the fuse or reset the circuit breaker only after determining the root cause of the problem.	
Magnets interfering with armature	Turn off the power and manually rotate the propeller. If the propeller does not rotate freely with a slight magnetic drag, contact a Service Center.		
Boat wiring faulty	Contact a Service Center.		
Inaccurate temperature reading (models with internal sonar)	Lower unit not fully submerged	Adjust the depth of the motor. Ensure the lower unit is fully submerged. Refer to <b>Adjusting the Motor Depth</b> .	
	Damaged nose cone	Contact a Service Center.	
	Damaged sonar cable	Contact a Service Center.	

# OWNER SERVICE ASSISTANCE

Symptom	Possible Cause	Resolution
Difficulty removing propeller	Bent propeller pin	Hold one blade and lightly tap the opposite blade with a rubber mallet.
		Use a putty knife on both sides of the propeller to apply equal pressure.
	Bent armature shaft	Contact a Service Center.

## Troubleshooting the Handheld Remote

### ERASING THE RECEIVER'S MEMORY

Erasing the receiver's memory will erase all electronic ID numbers that are stored in the receiver's memory.

1. Plug in the battery cable to a power source. In less than ten seconds, press the **left**, **propeller**, and **right** buttons on the handheld remote simultaneously.
2. Listen for a long beep indicating the receiver has erased all stored electronic ID numbers.

**NOTE:** If the buttons on the remote are not pressed simultaneously within ten seconds, or a long beep is not heard, unplug the battery cables from the power source and then refer to **Activating the Wireless Foot Pedal and Activating the Handheld Remote in the Product Installation, Wiring, and Battery Information** section of this manual.

### REPROGRAMMING THE REMOTE

**NOTE:** This activation procedure applies to the foot pedal and handheld remote.

**IMPORTANT:** To activate multiple foot pedals or remotes, the motor must be unplugged from the power source and then plugged back into the power source between activating each control device.

1. Deploy the trolling motor.
2. Unplug the battery cables from the power source. Wait 30 seconds and then reconnect the motor to the power source.
3. In less than ten seconds, press and hold the **left arrow** and **right arrow** buttons simultaneously on the handheld remote. For the foot pedal controller, hold the **propeller** and **anchor** button simultaneously.

### HANDHELD REMOTE BATTERY REPLACEMENT

Battery required: One AAA alkaline battery

# OWNER SERVICE ASSISTANCE

1. Remove the four screws from the back of the handheld remote. Remove the back cover.



**a** - Screws (4)

51837

2. Remove the old battery from the battery holder.

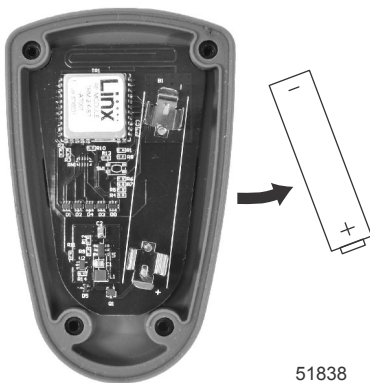

51838

3. Insert the new battery with the positive (+) side facing the positive (+) end of the battery holder.

# OWNER SERVICE ASSISTANCE

4. Ensure that the rubber seal is positioned correctly between the two halves of the handheld remote. Replace the handheld remote back cover and install the four screws. Carefully tighten the screws.

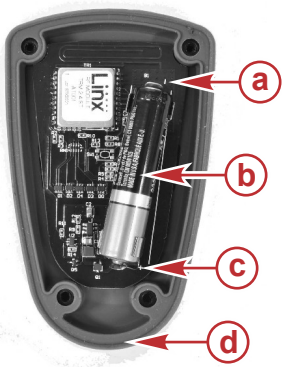

- a** - Negative (-) end of battery holder
- b** - Battery
- c** - Positive (+) end of battery holder
- d** - Rubber seal

51839

## Service Assistance

Your satisfaction with your product is very important to us. If you have a problem or question about your motor, contact your dealer or any certified MotorGuide Service Center. For more service assistance information, refer to **Warranty Information**.

The following information will be needed by the service office:

- Your name and address
- Daytime telephone number
- Model and serial number of your trolling motor
- Proof of purchase or registration verification
- Nature of problem

## Mercury Marine Service Offices

For assistance, call, fax, or write. Please include your daytime telephone number with mail and fax correspondence.

United States, Canada		
Telephone	English +1 920 929 5040 Français + 905 636 4751	Mercury Marine W6250 Pioneer Road
Fax	English +1 920 929 5893 Français +1 905 636 1704	P.O. Box 1939 Fond du Lac, WI 54936-1939
Website	www.mercurymarine.com	

# OWNER SERVICE ASSISTANCE

<b>Australia, Pacific</b>		
Telephone	+61 3 9791 5822	Brunswick Asia Pacific Group 41-71 Bessemer Drive Dandenong South, Victoria 3175 Australia
Fax	+61 3 9706 7228	

<b>Europe, Middle East, Africa</b>		
Telephone	+32 87 32 32 11	Brunswick Marine Europe Parc Industriel de Petit-Rechain B-4800 Verviers, Belgium
Fax	+32 87 31 19 65	

<b>Mexico, Central America, South America, Caribbean</b>		
Telephone	+1 954 744 3500	Mercury Marine 11650 Interchange Circle North Miramar, FL 33025 U.S.A.
Fax	+1 954 744 3535	

<b>Asia, Singapore, Japan</b>		
Telephone	+65 65466160	Brunswick Asia Pacific Group T/A Mercury Marine Singapore Pte Ltd 29 Loyang Drive Singapore, 508944
Fax	+65 65467789	