



# KODEN

## OPERATION MANUAL

---

### COLOR ECHO SOUNDER

«DIGITAL»

# CVS-128

«Broadband»

# CVS-128B

This product is specifically designed to be installed on boats and other means of maritime transport. If your country forms part to the EU, please contact your dealer for advice before attempting to install elsewhere.



## Declaration of Conformity

(As referred to in Annex IV 2. of Directive 2004/108/EC)

Declares under his sole responsibility that the produced Echo Sounder manufactured by

**Koden Electronics Co., Ltd.**

**5278 Uenohara**

**Uenohara-Shi,**

**Yamanashi-Ken**

**409-0112, Japan**

**Telephone +81 554 20 5860**

**Telefax +81 554 20 5875**

Identified by the type number **CVS-128** to which this declaration refers conforms to the relevant essential requirements of Directive 2004/108/EC and is in conformity with the EMC requirements of EU harmonised standard

**EN 60945: 2002 (Clauses 9, 10 & 12)**

Authorised representative in Europe

**Heinz Hoghoff**  
**Koden Elektronik GmbH.**  
**Am Gewerbepark 15**  
**D-64823, Gross-Umstadt**  
**Germany.**  
**Phone +49 6078 2056**  
**Telefax+49 6078 73824**

Signed .....  
**Heinz Hoghoff,**

Dated 15 April 2009 .....

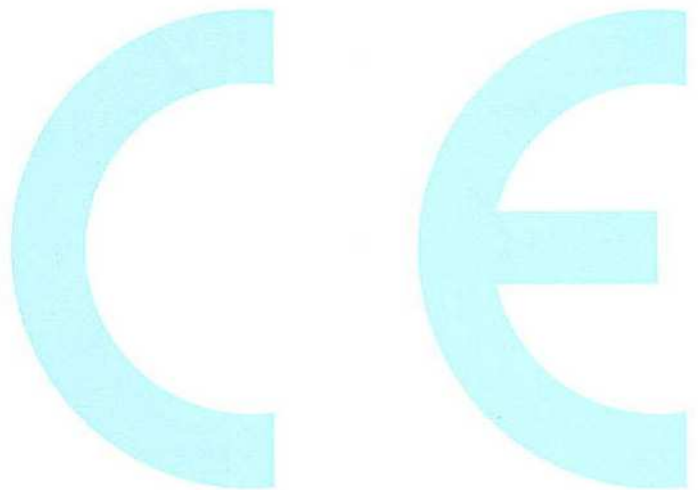

**N.B. As this product is for Maritime use compliance with Directive 72/23/EEC is not required.**



## Declaration of Conformity

(As referred to in Annex IV 2. of Directive 2004/108/EC)

Declares under his sole responsibility that the produced Echo Sounder manufactured by

**Koden Electronics Co., Ltd.**  
**5278 Uenohara**  
**Uenohara-Shi,**  
**Yamanashi-Ken**  
**409-0112, Japan**

**Telephone +81 554 20 5860**

**Telefax +81 554 20 5875**

Identified by the type number **CVS-128B** to which this declaration refers conforms to the relevant essential requirements of Directive 2004/108/EC and is in conformity with the EMC requirements of EU harmonised standard

**EN 60945: 2002 ( Clauses 9,10 & 12 )**

Authorised representative in Europe

**Heinz Hoghoff**  
**Koden Elektronik GmbH.**  
**Am Gewerbepark 15**  
**D-64823, Gross-Umstadt**  
**Germany.**  
**Phone +49 6078 2056**  
**Telefax+49 6078 73824**

Signed : .....  
Heinz Hoghoff,

Dated : 01 Jun. 2012 .....



Document No. 72-2731U-X003 .....

**N.B. As this product is for Maritime use compliance with Directive 72/23/EEC is not required.**

**CVS-128/128B Operation Manual**  
**Doc No. 0093112802**

**Document Revision History**

No.	Doc. No-Rev. No.	Revised Date (Y/M/D)	Revised Content
0	0093112802-00	2009/05/27	First edition
1	0093112802-01	2009/07/09	Chapter 1
2	0093112802-02	2010/01/12	Revision (From software KM-E79* Ver01.03 to Ver01.**)
3	0093112802-03	2011/04/27	Revision (From software KM-E79 Ver01.06 to Ver01.**) System Configuration, Configuration of Equipment, Chapter 5, Wording
4	0093112802-04	2011/12/26	Important Notice, Chapter 2, Chapter 6
5	0093112802-05	2012/06/15	Added CVS-128B Revision (From software KM-E79 Ver01.08 to Ver01.**)
6	0093112802-06	2013/06/24	Revision (From software KM-F22* Ver01.02 to Ver01.**) System Configuration, Configuration of Equipment, Chapter 5
7			
8			
9			
10			

\*KM-E79: CVS-128, KM-F22: CVS-128B

\*\*Subject to version change

**Document No. Revised Version Norm**

When part of the document needs to be revised, the document has advanced revision number.

The document No. is indicated at the lower right side on the cover and at the left or right side of the footer region of each page.

© 2009-2013 Kodens Electronics Co., Ltd. All rights reserved.

No part of this publication may be reproduced, transmitted, translated in any form by any means without the written permission of Kodens Electronics Co., Ltd. The technical descriptions contained in this publication are subject to change without notice. Kodens assumes no responsibility for any errors, incidentals or consequential damages caused by misinterpretation of the descriptions contained in this publication.





## Important Notice

- For copy and transcription of this Operation Manual (hereinafter referred to as this manual), permission from Koden is needed. Koden prohibits the un-authorized copy and transcription of this manual.
- If this manual is lost or damaged, consult a dealer of Koden or Koden.
- The specification of the products and the contents in this manual are subject to change without notice.
- The contents displayed on the menu of product may be different from the expression of this manual. The fonts and shapes of the keys and menus in the illustration may differ from the actual ones, and some parts may be omitted.
- Koden is not liable for damages and troubles arisen from misunderstanding of the contents in this manual.
- Koden is not liable for any damages caused by earthquake, lightning, wind and flood damage and fire for which Koden is not responsible, and actions by third parties, other accidents, customer's unintended error/abuse and the use under other abnormal conditions.
- Koden is not liable for damages of accompaniment (change/loss of memorized content, loss of business profit, stop of business) arisen from use or failure of our products.
- If the stored data are changed or lost, irrespective of causes of troubles and damages, Koden is not liable for them.
- Koden is not liable for any damages arisen from malfunction caused by combination of software and connected equipment in which Koden is not engaged.



## For Your Safe Operation



### Pictorial used in this Operation Manual

This Operation Manual uses the following pictorials. Understand the meaning of each pictorial and implement the maintenance and inspection.







Symbol	Meaning
 <b>Warning</b>	<b>Mark for warning</b> This symbol denotes that there is a risk of death or serious injury when not dealing with it correctly.
	<b>Mark for danger high voltage</b> This symbol denotes that there is a risk of death or serious injury caused by electric shock when not dealing with it correctly.
 <b>Caution</b>	<b>Mark for caution</b> This symbol denotes that there is a risk of slight injury or damage of device when not dealing with it correctly.
	<b>Mark for prohibition</b> This symbol denotes prohibition of the specified conduct. Description of the prohibition is displayed near the mark.

### Caution Item on Equipment

	<b>Be careful of a high voltage inside.</b> A high voltage, which may risk your life, is used. This high voltage remains in the circuit after you have powered off switch. To prevent touching the high voltage circuit inadvertently, the hard cover is provided to the high voltage circuit and the high voltage caution label is affixed. Ensure to power off switch for your safety and discharge the electricity remaining in the capacity before starting to check. An engineer authorized by our company should inspect and maintain
 <b>Warning</b>	<b>Be sure to power off in the boat.</b> If the power switch is inadvertently powered on during work, you will be electrified. To prevent such accident from occurring, ensure to power off in the boat and the power of equipment. Furthermore, it is safer to hang the caution tag described as [Under Work] near the power switch of equipment.
 <b>Warning</b>	<b>Be careful of dust</b> Inhaling dust may cause A respiratory disease. When cleaning the inside of equipment, be careful not to inhale dust. Wearing a safety mask is recommended.

 <p><b>Caution</b></p>	<p><b>Caution on location of equipment</b> Do not install the equipment where it is excessively damp and suffers from excessive water drops.</p>
 <p><b>Caution</b></p>	<p><b>Escaping from static electricity</b> The static electricity may be generated from the carpet on the floor in the cabin or clothes made of synthetic fiber. The static electricity may destroy the electronic parts on the circuit board. Handle the circuit board, taking the measure of static electricity free.</p>
 <p><b>Caution</b></p>	<p>Install the transducer at the location where it is not affected by bubble and noise The bubble and noise seriously degrade the performance of this unit.</p>

**Caution Item on Handling**

 <p><b>Warning</b></p>	<p>Do not disassemble or modify. It may leads to trouble, fire, smoking or electric shock. In case of trouble, contact our dealer or our company.</p>
 <p><b>Warning</b></p>	<p>In case of smoke or fire, boat power off and the power of this unit. It may cause fire, electric shock or damage.</p>
	<p>Be cautious of remaining high voltage. A high voltage may remain in the capacitor for several minutes after you have powered off. Before inspecting inside, wait at least 5 minutes after powering off or discharge the remaining electricity in an appropriate manner. Then, start the work.</p>
 <p><b>Caution</b></p>	<p>The information displayed in this unit is not provided directly for your navigation. For your navigation, be sure to see the specified material.</p>
 <p><b>Caution</b></p>	<p>Use the specified fuse. If un-specified fuse is used, it may cause a fire, smoke or damage.</p>
 <p><b>Caution</b></p>	<p>Whenever transmitting, be sure to submerge the transducer in water first. If transmitted without submerging the transducer, it may be damaged.</p>

## Contents

Document Revision History.....	i		
Important Notice.....	ii		
For Your Safe Operation .....	iii		
Contents.....	v		
Introduction.....	ix		
System Configuration .....	x		
Configuration of Equipment .....	xi		
Change the frequency .....	xiv		
Chapter 1 Basic Operation .....	1-1		
1.1 How to use the key .....	1-1		
How to remove the hard cover... 1-2			
When removing the			
CVS-128/128B Display unit .....	1-2		
The clean of CVS-128/128B			
Display unit .....	1-2		
1.2 Power On/Off .....	1-3		
Power on.....	1-3		
Power off.....	1-3		
Alarm of Power Voltage .....	1-3		
1.3 LCD Brilliance Adjustment .....	1-4		
Adjustment of LCD Brilliance .....	1-4		
Brightness Adjustment of Panel			
Brilliance .....	1-4		
1.4 Switch-over of Display mode .....	1-4		
Normal Image (Low frequency,			
High frequency).....	1-4		
Dual frequency.....	1-5		
Zoom (Low frequency, High			
frequency) .....	1-5		
Navigation Menu (NAV1, NAV2) 1-7			
1.5 Selection of NAV Display .....	1-8		
Type of NAV Display .....	1-8		
Selection of NAV Menu .....	1-8		
1.6 Switch-over of Range .....	1-9		
		Setting the range switching to auto	
		range.....	1-9
		Setting the range switching to	
		Manual range .....	1-9
1.7	Setting of Shift.....		1-9
	Setting of Manual Shift.....		1-9
	Release of manual Shift.....		1-10
	Setting of Auto Shift .....		1-10
1.8	Gain Adjustment.....		1-10
	Basic Operation of Gain.....		1-11
	Selecting the auto gain .....		1-11
	Adjusting the gain by auto .....		1-11
	Selecting the manual gain .....		1-11
	Manual adjustment of the gain. 1-11		
1.9	Use of [EVENT] key.....		1-12
	Selecting the event key function1-12		
	Presetting the waypoint .....		1-12
	Store the image.....		1-13
	Fishing hot spot.....		1-13
1.10	Use of [F1] / [F2] key.....		1-14
	Selecting the		
	[F1] / [F2] key .....		1-14
	Preset of [F1] / [F2] key .....		1-14
1.11	Operation of VRM .....		1-15
1.12	Display of fish information.....		1-15
	Display the fish symbol /Stop the		
	display of fish symbol.....		1-16
	Selecting the symbol info.....		1-16
	Fish symbol detection		
	adjustment .....		1-16
	Size adjustment .....		1-16
	Big fish / Big fish color .....		1-17
	Points to note in use of fish		
	symbol.....		1-17
	Chapter 2 How to use the Menu .....		2-1
2.1	How to operate the menu .....		2-1



Display the menu / Stop the display of menu .....	2-1	Switch-over of Sona-Tone™ .....	2-12
Menu Operation .....	2-1	Connection of External Speaker .....	2-12
2.2 Changing of Image Speed.....	2-2	2.17 Explanation of Menu Item .....	2-12
2.3 Rejection of Interference .....	2-2	Inner-hull .....	2-12
Interference Rejection .....	2-2	TVG .....	2-13
2.4 Color Rejection of Weak Echo ...	2-3	Change the TX power .....	2-13
Color Rejection.....	2-3	Change the Pulse width .....	2-13
2.5 Rejection of Noise .....	2-3	Change the Bandwidth.....	2-14
Noise Rejection .....	2-3	D. Range .....	2-14
2.6 Setting of Shift step .....	2-3	Display Width .....	2-14
2.7 Selection of Zoom .....	2-3	Display the A scope / Stop the display of A scope .....	2-14
2.8 Setting of Zoom Range .....	2-4	Change the display color of echo sounder image .....	2-14
2.9 Setting of Zoom Start .....	2-4	Change the depth value .....	2-15
2.10 Preset of Range .....	2-4	Display the depth unit / Stop the display of depth unit .....	2-15
Easy registration method of the range .....	2-5	Display the water temp graph / Stop the display of water temp graph .....	2-15
2.11 Setting of Background Color .....	2-5	Setting of the background color of NAV display .....	2-15
2.12 Setting of White Line .....	2-5	Setting of the echo sounder display at NAV display.....	2-15
2.13 Setting of Alarm.....	2-6	Image Swap .....	2-15
Stopping the alarm sound .....	2-6	Display the Operation guide / Stop the display of Operation guide.....	2-15
Setting the alarm .....	2-7	Display the detection area / Stop the display of detection area .....	2-16
Release the alarm .....	2-7	Setting of Scale display.....	2-16
Confirm the alarm state.....	2-7	Change the scale value.....	2-16
2.14 Preset/ WPT edit/ WPT delete of Waypoint.....	2-8	Change the image direction .....	2-16
NAV Start.....	2-8	Setting of Depth measurement	2-16
Cancel the NAV.....	2-8	Change the display color.....	2-16
Edit the destination.....	2-8	Setting of Key lock .....	2-17
Delete the waypoint.....	2-9	Change the scale type .....	2-17
Recall the stored image and preset it as a destination .....	2-9		
2.15 Store/Recall/Deletion of Image	2-10		
Store the image .....	2-10		
Recall the stored image .....	2-10		
Delete the stored image .....	2-11		
Add the comment to the stored image.....	2-11		
2.16 Explanation of Sonar.....	2-12		

Change the bottom color .....	2-17	All WPTs deletes .....	3-4
Change the image partition.....	2-17	All stored image deletes .....	3-4
Display the frequency / Stop the display of frequency .....	2-17	Bottom start.....	3-4
Selecting a display area of fish symbol indication .....	2-17	Past image .....	3-4
Chapter 3 How to use the menu2 .....	3-1	Inner-hull .....	3-4
3.1 Display of Menu .....	3-1	TD select.....	3-4
Display the menu .....	3-1	3.6 Setting of Adjust2 Item.....	3-4
Return to the normal menu .....	3-1	STC strength adjust Low / High.	3-4
3.2 Setting of External Input/Output.	3-1	STC depth adjust Low / High .....	3-4
Buzzer Setting.....	3-1	Color adjust.....	3-5
Temp Source .....	3-1	Image speed adjust.....	3-5
Speed Source .....	3-1	Bottom limit .....	3-5
Baud Rate .....	3-1	Sounding.....	3-5
NMEA Monitor.....	3-2	3.7 Frequency select.....	3-5
NMEA Output Data .....	3-2	Frequency select (Low / High) ...	3-5
3.3 Setting of Correction Item .....	3-2	Power frequency adjustment .....	3-5
Draft Set.....	3-2	Chapter 4 Maintenance and Inspection ..	4-1
Sonic Speed.....	3-2	4.1 Inspection.....	4-1
Water Temp.....	3-2	4.2 Cleaning.....	4-1
Boat Speed .....	3-2	CVS-128/128B Display unit .....	4-1
Directivity angle (Low/High) .....	3-2	Transducer .....	4-1
Bubble .....	3-3	4.3 Fuse Replacement.....	4-2
Bubble time set .....	3-3	4.4 If you suspect a trouble.....	4-2
3.4 Setting of Basic Set Item .....	3-3	4.5 Diagnostic Test.....	4-3
Language .....	3-3	Diagnose .....	4-3
Range & Speed Unit .....	3-3	Confirm the version.....	4-3
Depth Unit .....	3-3	Return to the menu .....	4-3
Temperature Unit .....	3-3	Chapter 5 Installation .....	5-1
Local time Offset .....	3-3	5.1 Items of Caution on Installation .	5-1
GPS select .....	3-3	Unpacking the components .....	5-1
GPS initialize.....	3-3	Inspection of components and accessories .....	5-1
3.5 Maintenance Menu .....	3-3	Decision of Installing Location ...	5-1
Simulation .....	3-3	Laying and Connection of Cable	5-2
Slide show.....	3-4	Confirmation after Installation ....	5-2
Initialize .....	3-4	5.2 Installation of CVS-128/128B	
System Check.....	3-4	Display unit.....	5-3
		Desk-top Installation .....	5-3

	Flush-mount Installation .....	5-5
5.3	Installation of Transducer .....	5-6
	In case of Inner-hull.....	5-6
	In case of Through hull.....	5-7
5.4	Wiring .....	5-8
	Connection of Cable to CVS-128/128B Display unit.....	5-8
	Pin Assignment of Rear Connector.....	5-8
	Connection of Power Cable .....	5-9
	Connection of Transducer .....	5-10
	Connection with external equipment.....	5-11
	Connection with GPS-20A .....	5-11
	Connection with Speed Sensor or Water Temperature Sensor (Optional) .....	5-12
	Connection of External Speaker for Sona-Tone™ (Prepared by a customer) .....	5-13
	Connection of External Monitor (J7) (Prepared by a customer) .	5-13
5.5	Serial Data.....	5-14
	Input Data.....	5-14
	Output Data .....	5-14
Chapter 6 Table Attached.....		6-1
6.1	Menu List.....	6-1
6.2	Specification .....	6-5
6.3	Appearance .....	6-7

## Introduction

The CVS-128/128B is a Dual frequency Color LCD display echo sounder.

This unit equipped with digital process displays the circumstance in the water under all conditions, matching with the high luminance 8.4 inch LCD.

The main features of this unit are as follows:

- With the digital reception process, the compatibility of the high resolution in a shallow depth and the noise rejection capability in a deep depth are established. The auto mode function provides the best image.
- The high-performance LCD maintains high visibility under any conditions.
- The unit can be installed in an open bridge and is highly waterproof.
- Sona-Tone (Sonar sound) function is equipped with for catching situations schools of fish and others by sound.
- Up to 10 images can be stored. If you connect the optional GPS, the fishing hot spot function, that directs your boat to navigate easily to the location desired, is available by marking the event mark when recalling the stored image.
- With the adoption of a specific filter (AR coat), an image can be seen clearly, refusing sunshine. The countermeasures against the reflection on the LCD screen and dew are provided.
- The various alarm functions are available. (Bottom, school of fish, water temperature\*, boat speed\*, arrival\*, XTE\*, power) (Note: The mark \* denotes that the connection of option is mandatory)
- When flush-mounting, the unit can be easily installed from front side.
- The RGB output for an external monitor is provided as standard equipment. The use of the external monitor enables you to observe easily the echo sounder screen at a location which is remote from a main unit. (External monitor: Prepared by a customer)
- CVS-128B is the high sensitivity model with broadband transducer. This model can be used at your optimum frequencies within the specification of the broadband transducer. You can set 2 frequencies depending on a target fish or intended purpose during operation.

# System Configuration

## Connection Diagram

CVS-128/128B Display unit  
With mounting bracket and hard cover

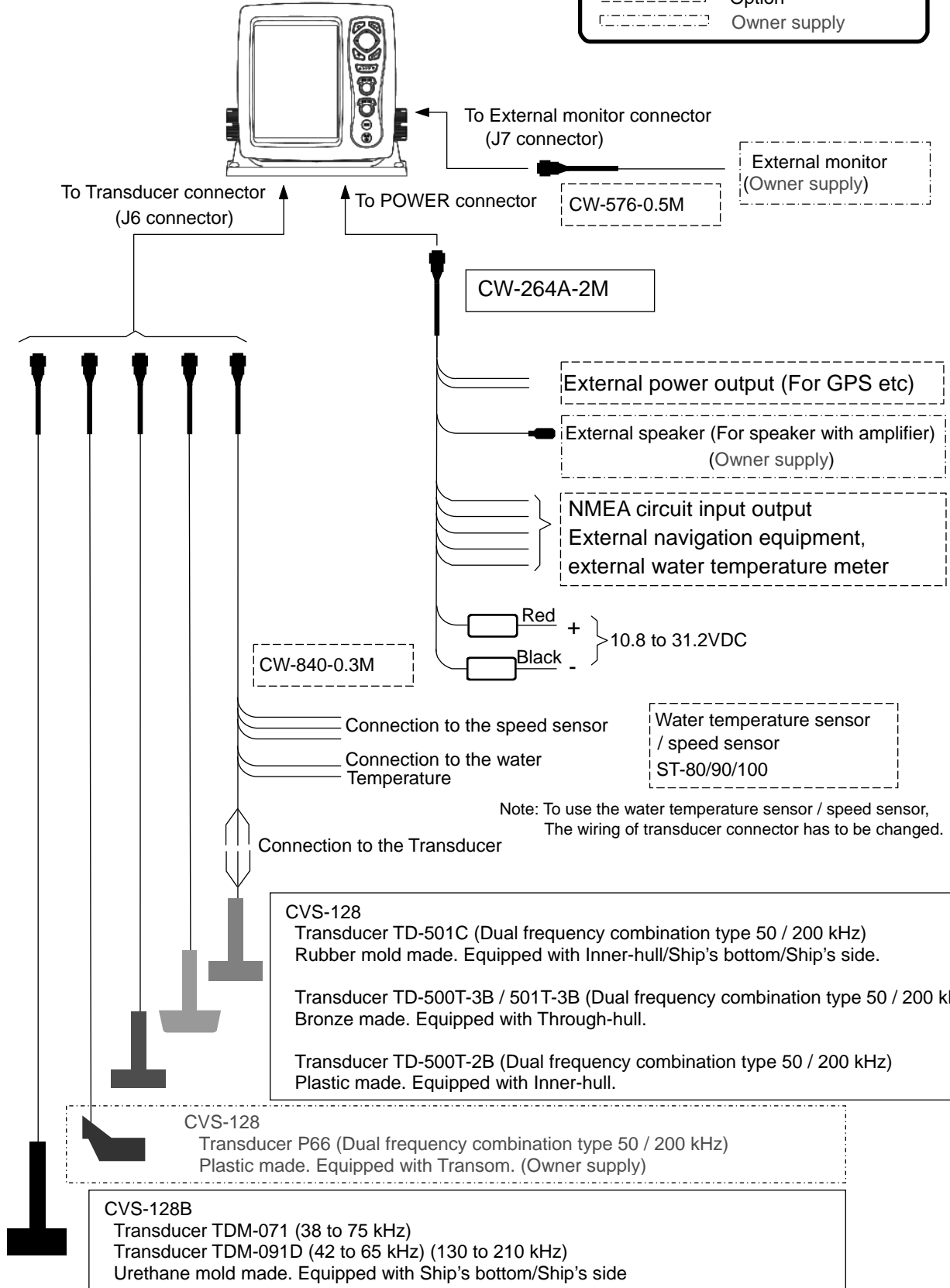

**Legend**

- Standard configuration
- Option
- Owner supply



## Configuration of Equipment

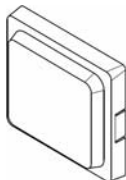
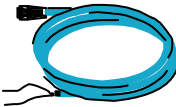

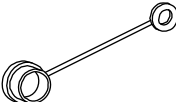
### Standard Equipment Configuration List

No.	Name of item	Type	Remark	Weight/ Length	Quantity
1	Display unit 	CVS-128/128B	With mounting bracket and knob	3.2 kg	1
2	Hard cover 	E57MB11060		250 g	1
3	DC power cable (Combined cable) 	CW-264A-2M	With 12 connector at one end/ un-treated at the other end	2 m	1
4	Fuse 	F-7161-3A Cylinder (ø 6.4x30)	Normal fusion type for main power		2
5	Cap 	LTWCAP-DABCFXC1	For transducer cable connector		1
6	Operation Manual	CVS-128.OM.E	English		1
7	Quick Reference	CVS-128.QR.E	English		1
8	Cautionary Note	CVS-SER.RM.E	English		1

### Essential Option

No.	Name of item	Type	Remark	Weight/ Length	Quantity
1	Transducer	Type of transducer	transducer cable (with connector at one end)		1

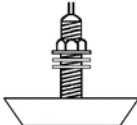
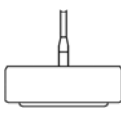
Type of transducer

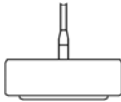
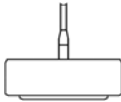
No.	Specification	Frequency	Material / Length of the cable	Mounting method	Beam width (Right and left x back and forth)
1	 <p>TD-500T-2B</p>	<p>CVS-128</p> <p>50/200 kHz 600 W</p>	<p>Plastic</p> <p>9m</p>	<p>Inner-hull</p>	<p>50kHz 50°x50° (-6dB)</p> <p>200kHz 17°x17° (-6dB)</p>
2	 <p>TD-500T-3B</p>	<p>CVS-128</p> <p>50/200 kHz 600 W</p>	<p>Bronze</p> <p>9m</p>	<p>Through-hull</p>	<p>50kHz 50°x50° (-6dB)</p> <p>200kHz 17°x17° (-6dB)</p>
3	 <p>TD-501C</p>	<p>CVS-128</p> <p>50/200 kHz 1 kW</p>	<p>Rubber mold</p> <p>10m</p>	<p>Inner-hull/ Ship's bottom/ Ship's side (The CW-840-0.3M is needed)</p>	<p>50kHz 58°x20° (-6dB)</p> <p>200kHz 17°x 6° (-6dB)</p>
4	 <p>TD-501T-3B</p>	<p>CVS-128</p> <p>50/200 kHz 1 kW</p>	<p>Bronze</p> <p>9m</p>	<p>Through-hull</p>	<p>50kHz 20°x22° (-6dB)</p> <p>200kHz 5°x 5° (-6dB)</p>
5	 <p>TDM-071</p>	<p>CVS-128B</p> <p>38 to 75 kHz</p>	<p>Urethane mold</p> <p>15m</p>	<p>Through-hull Ship's bottom/ Ship's side</p> <p>With water temperature sensor.</p>	<p>38kHz 30°x20° (-6dB)</p> <p>75kHz 16°x 10° (-6dB)</p>
6	 <p>TDM-091D</p>	<p>CVS-128B</p> <p>42 to 65 kHz 130 to 210kHz</p>	<p>Urethane mold</p> <p>15m</p>	<p>Through-hull Ship's bottom/ Ship's side</p> <p>With water temperature sensor.</p>	<p>42kHz 35° (-6dB)</p> <p>65kHz 22° (-6dB)</p> <p>130kHz 14° (-6dB)</p> <p>210kHz 8° (-6dB)</p>

 **Caution: For Inner-hull installation, an Inner-hull kit is necessary.**

AIRMAR's Transducer model P66 is also applicable. (Owner supply)

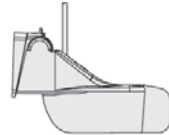
1	 <p>P66</p>	<p>CVS-128</p> <p>50/200 kHz 600 W</p>	<p>Plastic</p> <p>10m</p>	<p>Transom</p> <p>With water temperature sensor and speed sensor. (The CW-840-0.3M is needed)</p>	<p>50kHz 69°x69° (-6dB)</p> <p>200kHz 16°x16° (-6dB)</p>
---	--	--	---------------------------	---	--



## Option List

No.	Name of Item	Specification	Remark	Weight/Length
1	Water temperature sensor/speed sensor	ST-80	For transom mounting Plastic made (with cable)	0.3 kg / 9 m
		ST-90	For through-hull mounting Plastic made (with cable)	0.6 kg / 9 m
		ST-100	For through-hull mounting Bronze made (with cable)	1.2 kg / 9 m
2	GPS sensor	GPS-20A-10M-B [KODEN]	For GPS measuring (With power & signal cable)	0.25 kg / 10 m
3	Inner-hull kit	MFB-04	Plastic made for installing the transducer TD-500T-2B	1.3 kg
		MFB-04W	Plastic made for installing the transducer TD-501C	1.3 kg
4	Cable for transducer	CW-840-0.3M	Needed when using the optional water temperature sensor / speed sensor.	30 cm
5	Connector for GPS sensor	LTWBD-06PMMP-LC	Needed when using the GPS-20A (Type B) sensor.	
6	Cable for external monitor	CW-576-0.5M	Junction cable for connection of external monitor	0.5 m



## Change the frequency

CVS-128B is used with the other transducer please make sure to set the below items manually in line with the transducer installed.

-  **Caution: The transducer may be damaged if the settings are wrong.**
-  **Caution: There are occasions too much noise is generated in a particular frequency to be connected.**
-  **Caution: Fish symbol operation cannot be generated at the other frequencies than the high frequency of 200 kHz and the low frequency of 50 kHz.**

### Setting of Output Frequency (CVS-128B)

- 1 Press the [MENU] key.
- 2 Select [Freq] → [Freq select (L)]. (See [2.1 How to operate the menu])
- 3 Press the [▶] key.
- 4 Set the output frequency at the low frequency side. (Press the [▲] key or [▼] key)
- 5 Set the high frequency also in the same way as for the low frequency side, in reference to the step 2 to 4.
- 6 Press the [MENU] key. Then, the edit is finished.

-  **Caution: When single transducer is connected, set the same frequencies for low and high.**

### Setting of Power Frequency (CVS-128B)

- 1 Press the [MENU] key.
- 2 Select [Freq] → [Power freq adj]. (See [2.1 How to operate the menu])
- 3 Press the [▶] key.
- 4 Set the power supply frequency. (Press the [▲] key or [▼] key)

The recommended power supply frequency for Dual frequency (50 kHz/200 kHz): 107.0 kHz

Transmit frequency	Recommended power supply frequency	Transmit frequency	Recommended power supply frequency
28 kHz	115.0 kHz	70 kHz	106.5 kHz
38 kHz	105.0 kHz	75 kHz	103.5 kHz
40 kHz	123.0 kHz	120 kHz	109.0 kHz
55 kHz	107.0 kHz	-	-

-  **Caution: There may be much noise on the screen even for the recommended power supply frequency depending on the transducer. In this case, set the power supply frequency to reduce the noise on the screen.**

-  **Caution: Set the power supply frequency to reduce the noise on the screen, when the other transmission frequency than above is used.**

- 5 Press the [MENU] key. Then, the edit is finished.

### Adjustment of bottom detection

When the bottom can't be detected or when the bottom is of mud pool or seaweed, [Gain (TD)] shall be turned up. When transfer to fish schools, etc. frequently occurs, [Gain (TD)] shall be turned down.

- 1 Press the [MENU] key.
- 2 Select [Adjust] → [Gain(TD)]. (See [2.1 How to operate the menu])
- 3 Press the [▶] key. The image displays bottom only. It may show very strong fish targets.
- 4 Set a value to display the sea bottom continuously without interruption. For high frequency, turn [GAIN (HF) knob] and for low frequency, turn [GAIN (LF) knob]

After the alteration of setting, please confirm the condition for some time.

Those adjustments are recommended to be performed at the site of use.

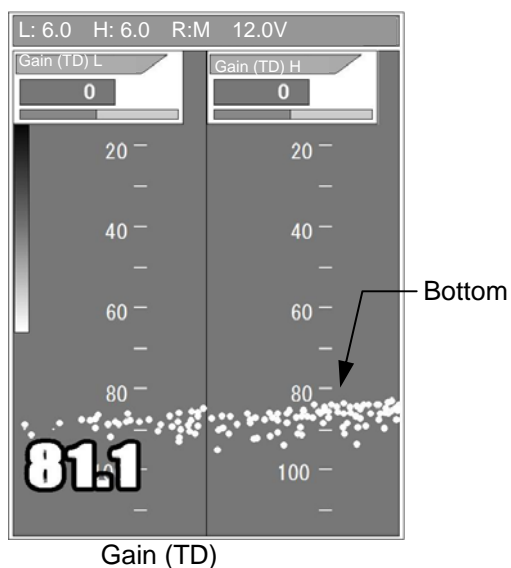

- 5 Press the [MENU] key. Then, the edit is finished.

# Chapter 1 Basic Operation

## 1.1 How to use the key

CVS-128/128B Display unit

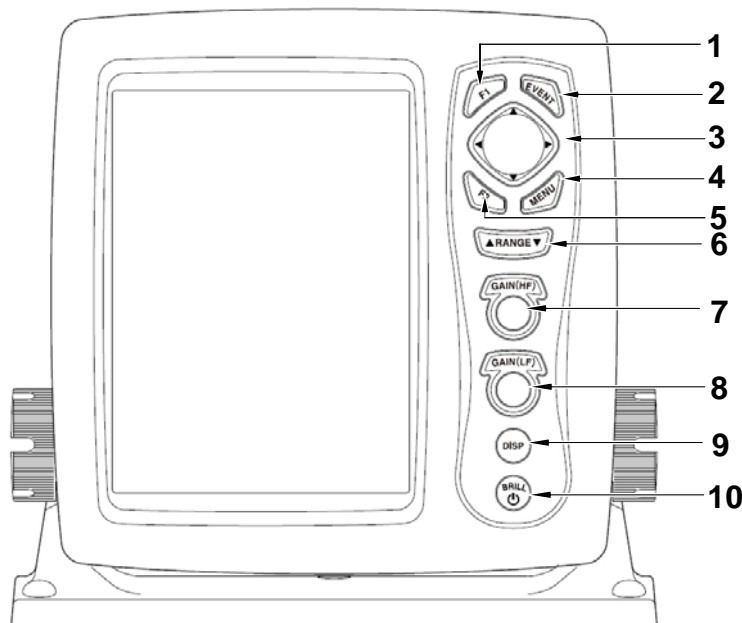

Various setting can be done directly. The menu list closes automatically after the key operation of the other keys than [menu].

No.	Key Name	Explanation
1	[F1]	Recalls directly the item preset.
2	[EVENT]	Notifies the external equipment of the present position. Presets the menu. It begins a fishing hot spot.
3	[Cursor] ▲▼◀▶	Selects the menu item. Changes the set value. Moves the VRM marker. Moves the marker for notifying the event.Changes the shift.
4	[MENU]	Opens or closes the menu.
5	[F2]	Recalls directly the item preset.
6	[▲RANGE▼]	Changes the range setting.
7	[GAIN(HF) Knob]	Rotate: Changes the gain value. Press: Recalls the gain select.
8	[GAIN(LF) Knob]	Rotate: Changes the gain value. Press: Recalls the gain select.
9	[DISP]	Switches to the High frequency or Low frequency of echo sounder image, zoom and navigation menu.
10	[BRILL⓪]/ Power	Press: Power on. Adjusts the brilliance and brightness of panel. Long-press: Power off.

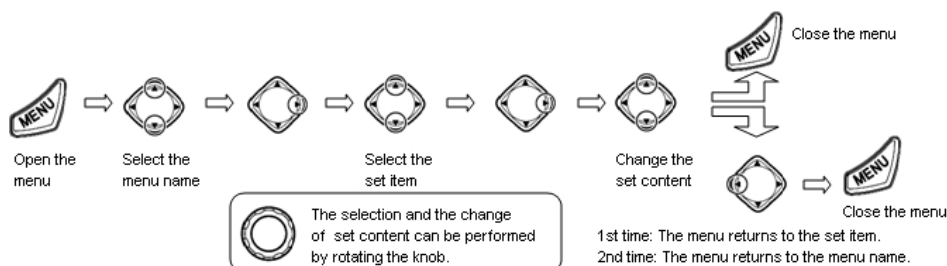

### How to remove the hard cover

While widening the claws at right and left sides of hard cover, draw the hard cover towards you.

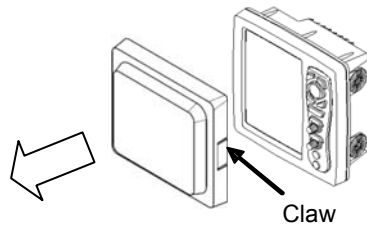

### When removing CVS-128/128B Display unit

To prevent dust from entering, cap the connector at the rear of CVS-128/128B Display unit and the power cable with caps.

Install the supplied cap to the transducer cable as shown in the figure and cap it.

**! Caution: Do not pull the cable strongly. If you do so, it will be broken.**

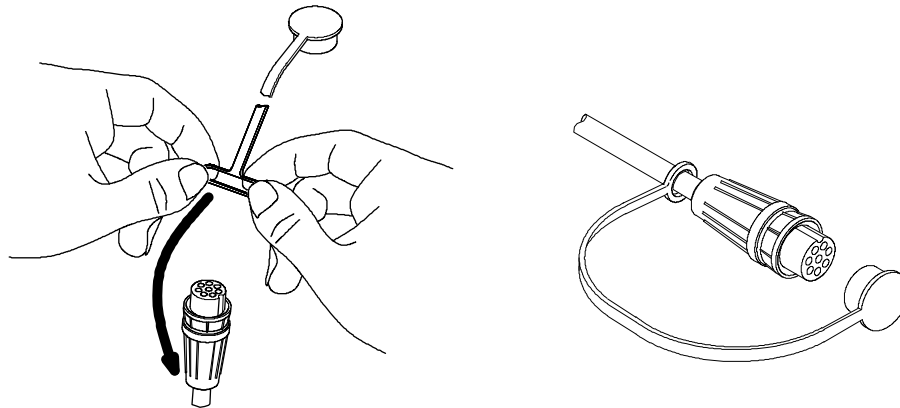

### The clean of CVS-128/128B Display unit

The cleaning of the display unit goes after removing the front-frame. After removing the front-frame, use a synthetic detergent and OA cleaner and wipe the display unit lightly. Then dry sufficiently, and return the front- frame to original position.

**! Caution: The display unit has a special coating. Do not use a solvent such as paint thinner, acetone, alcohol, and benzene, etc.**

**! Caution: Strong rubbing may cause bruising and scratching.**

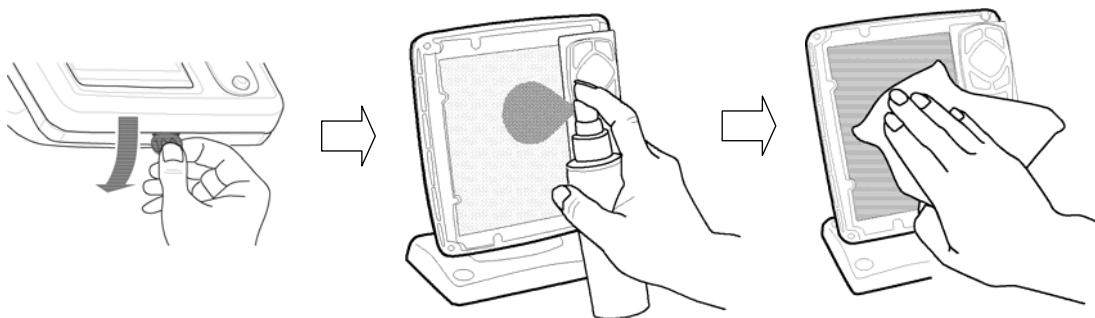

## 1.2 Power On/Off

### Power on

- 1 Press the [BRILLÖ] key to power on. The startup menu is displayed. When started up, the internal memories (ROM, RAM) are automatically checked. When checking is normally finished, the menu below is displayed.

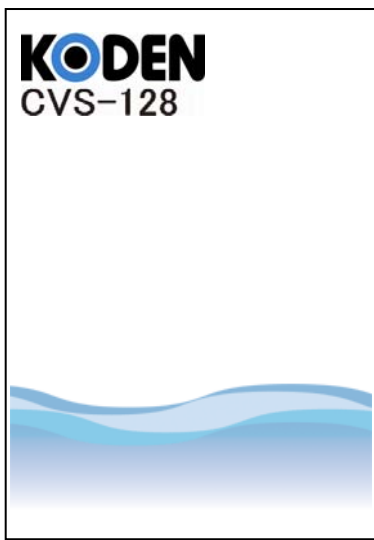

**Caution:** If an error occurs in the memory check, the LED on the operation panel blinks. The unit may be not function normally. If you suspect trouble, contact the dealer of your purchase or our company.

- 2 Language Selection at Initial Startup.

When powering on first, the [Language] menu is displayed.



Select the language with [▲] key or [▼] key. (The language can be selected by rotating the [GAIN (HF) Knob] or [GAIN (LF) Knob].)

- 3 When the installation of a transducer is [Inner-hull], select the [Yes].

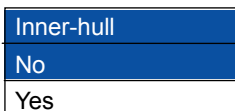

Press [▶] and [▼] keys in sequence, and select the [Yes].

- 4 Press the [MENU] key to decide the language and the inner-hull.
- 5 After a few seconds, the menu sets the screen as selected in [DISP].

**Caution:** In addition to English, Japanese, there are several compatible languages.

Explanation of the display:

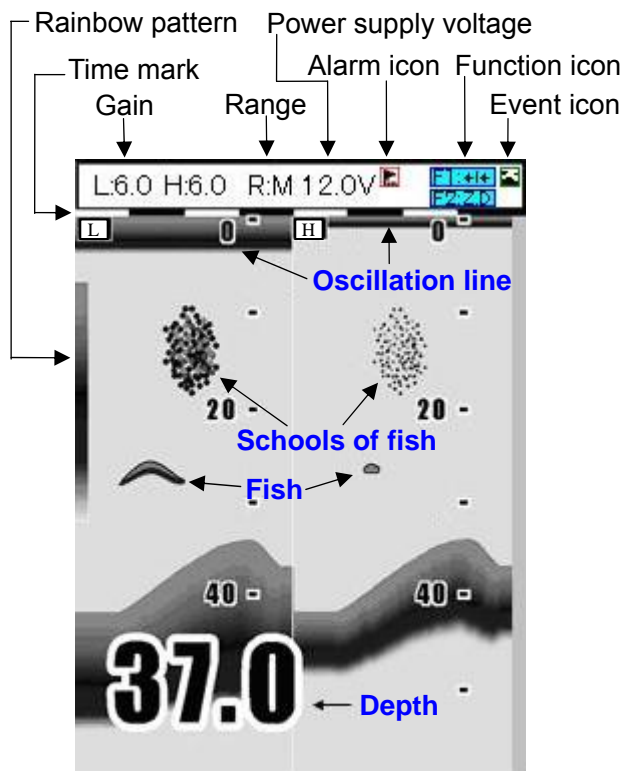

Type of Gain  
 H: High frequency gain  
 L: Low frequency gain

Type of Range  
 R: M: Manual Range  
 R: A: Auto Range  
 R: AS: Auto Shift

### Power off

- 1 When powering off, keep pressing the [BRILLÖ] key for 3 seconds. The remaining time for the power to shut off is displayed on the menu.

### Alarm of Power Voltage

If detecting the malfunction of the voltage, the icon blinks and the alarm beeps.

**Caution:** In case of the low voltage or the high voltage, it shuts down. The precision of Power Voltage is ± 0.5 V.

### 1.3 LCD Brilliance Adjustment

#### Adjustment of LCD Brilliance

The brilliance of the display can be adjusted to facilitate visualization.

The [Lcd brill] and [Panel brill] can be switched every time when pressing the [BRILLÖ] key.

- 1 Press the [BRILLÖ] key for a short period of time to display the menu ([Lcd brill]).
- 2 Rotate the [GAIN (HF) Knob] or [GAIN (LF) Knob]. When "1" is selected, it is darkest. When "10" is selected, it is brightest.

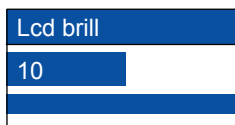

- 3 Press the [MENU] key to close the menu.

#### Brightness Adjustment of Panel Brilliance

The brightness of panel can be adjusted.

The [Lcd brill] and [Panel brill] can be switched every time when pressing the [BRILLÖ] key.

- 1 Press the [BRILLÖ] key for a short period of time to display the menu ([Panel brill]).
- 2 Rotate the [GAIN (HF) Knob] or [GAIN (LF) Knob]. When "1" is selected, it is darkest. When "10" is selected, it is brightest.

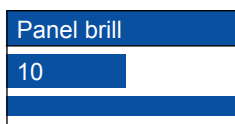

- 3 Press the [MENU] key to close the menu.

### 1.4 Switch-over of Display mode

7 kinds of displays are provided in all. Select the display suitable for your purpose.

- 1 Press the [DISP] key.
- 2 Select the display you desire to display. (Press the [▲] key or [▼] key.) (The set item can be selected by rotating the [GAIN (HF) Knob] or [GAIN (LF) Knob].)

Disp
NAV1
Normal (H)
Zoom (H)
Dual Freq
Zoom (L)
Normal (L)
NAV2

(H): High frequency

(L): Low frequency

NAV1: Navigation display1

NAV2: Navigation display2

- 3 Press the [MENU] key to close the menu.

#### Normal Image (Low frequency, High frequency)

##### Low frequency

Since the beam width is wide, the search range becomes wide so that the beam can search the deep depth.

##### High frequency

Since the beam width is narrow, it is hard to be interfered by noise and bubble in the sea so that the schools of fish can be searched in a high resolution.

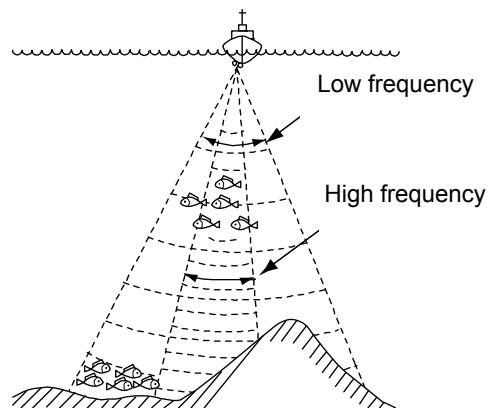

**Dual frequency**

The High frequency image can be displayed in the right half side and the Low frequency image can be displayed in the left half side. Since the beam width differs depending on frequency, the schools of fish and sea bottom look different.

**⚠ Caution: The low frequency screen can be displayed in the right half of the screen by replacing the screen and the high frequency screen is displayed in the left half. (See [2.17 Explanation of Menu Item, Image Swap])**

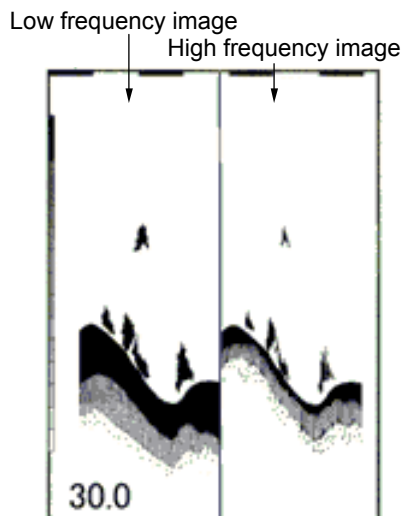

**Zoom (Low frequency, High frequency)**

The normal image is displayed in the right half of the screen and the zoom image is displayed in the left half. A part of normal image can be zoomed. (1) [BTM.] (Bottom), (2) [B.D.] (Bottom Discrimination), (3) [Zoom], (4) [B.Z.] (Bottom Zoom) and (5) [B.F.Z.] (Bottom Follow Zoom) are provided for zoom.

The unit is set to (1) [BTM.] at ex-factory. To change to other zoom display, set it in the menu. (See [2.7 Selection of Zoom])

**⚠ Caution: A right and left display can be switched. (See [2.17 Explanation of Menu Item, Image Swap])**

Zoom type	Purpose	Zoom start position	Zoomed range
Bottom	It is convenient to see the schools of fish near the bottom.	It displays the position of the bottom in the fixation in the display bottom part.	It displays the bottom and upper in the zoom.
Bottom Discrimination	It is convenient to see the schools of fish and a bottom quality near the bottom.	It displays the position of the bottom in the fixation in the position of 1/4 under the display.	It displays the bottom and upper in the zoom, it displays under the bottom in the ordinary. (Under the bottom, it doesn't display in the zoom).
Zoom	It is convenient to see the specified range in the zoom.	It displays a zoom start position in the fixation at the top of the display.	It displays in the zoom from the zoom start position to the range you set.
Bottom Zoom	It is convenient to see the schools of fish near the bottom and the form of the bottom.	It displays the position of the bottom in the position which is the same as the ordinary display.	It displays upper side of the bottom in the zoom except the bottom.
Bottom Follow Zoom	It is convenient to see the schools of fish near the bottom and the form of the bottom.	It always displays the position of the bottom in the lower part of the display.	It displays the bottom and upper and lower sides in the zoom.

**(1) Bottom**

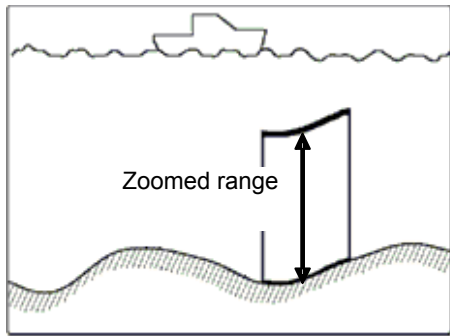

The display width of zoom is displayed in orange.

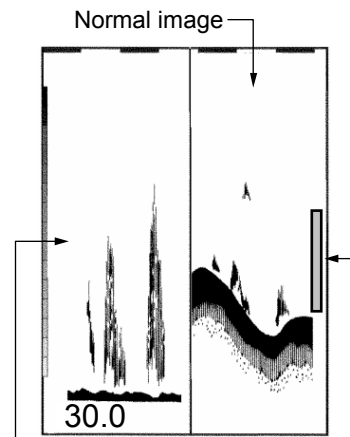

Zoom image

**(2) Bottom Discrimination**

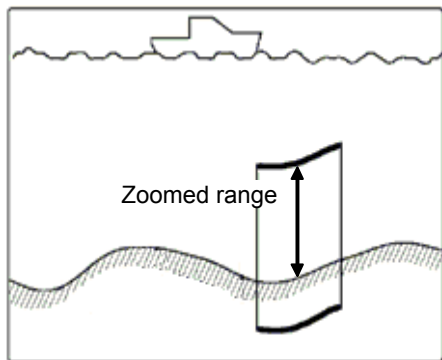

The display width of zoom is displayed in orange.

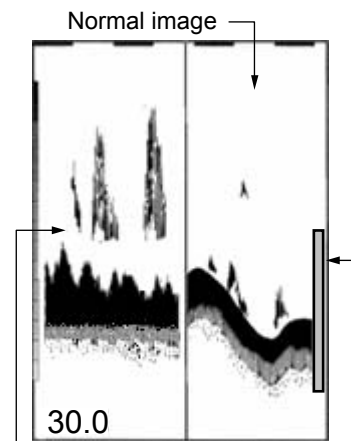

Zoom image

**(3) Zoom**

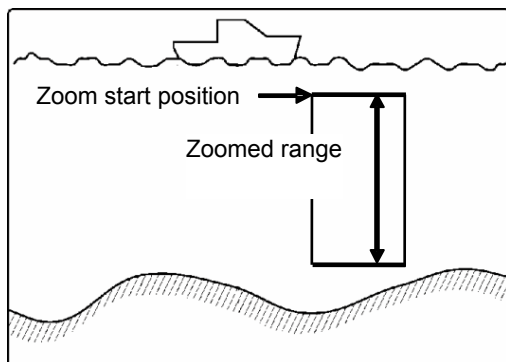

The display width of zoom is displayed in orange.

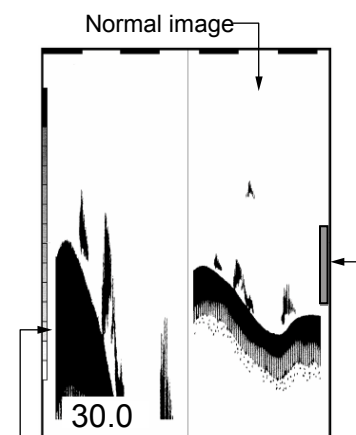

Zoom image



**(4) Bottom Zoom**

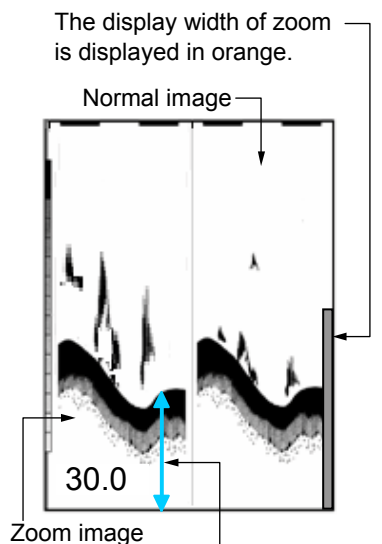
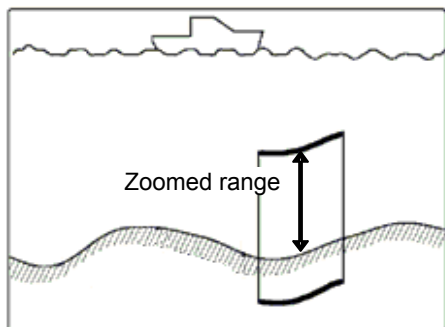

The display width of zoom is displayed in orange.

Normal image

Zoom image

The image below the bottom is not zoomed.

**(5) Bottom Follow Zoom**

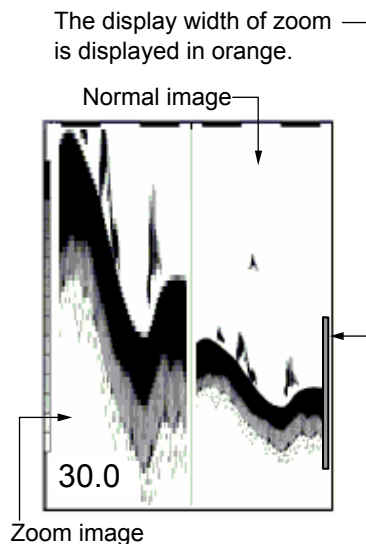
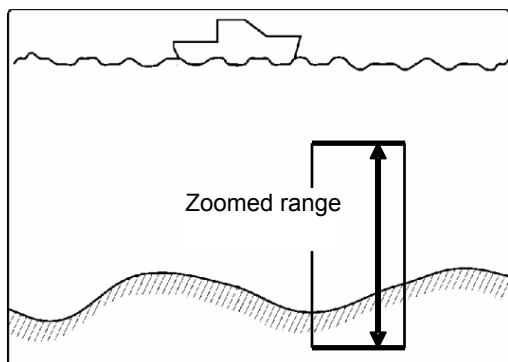

The display width of zoom is displayed in orange.

Normal image

Zoom image

**Navigation Menu (NAV1, NAV2)**

The navigation menu can be displayed on the left side of the display. To display the information other than depth, sensors need to be connected. (See [1.5 Selection of NAV Display])

**! Caution: Requires position data from GPS sensor.**

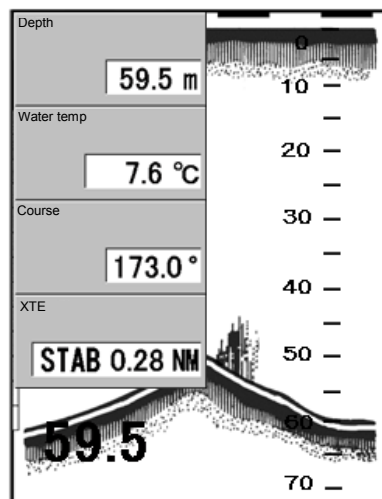
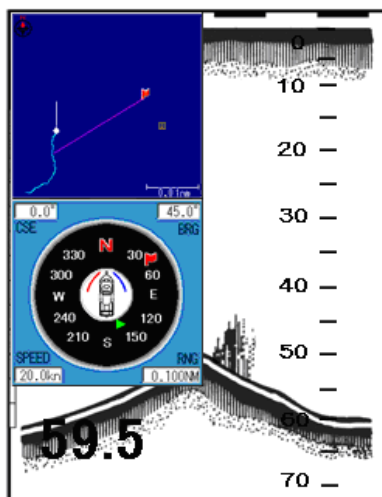

## 1.5 Selection of NAV Display

### Selection of NAV Display

The information can be displayed on the NAV display (NAV 1, NAV2).

**Caution:** Requires position data from GPS sensor.

### Type of NAV Display

The following images can be displayed on the NAV Display (NAV1, NAV2).

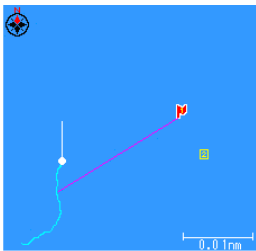

Simple plotter

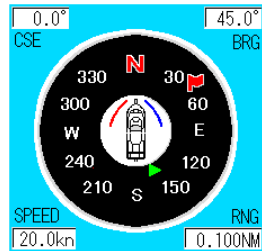

Compass

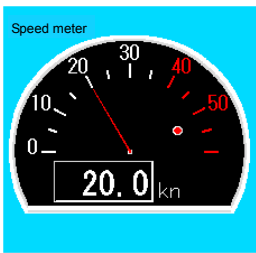

Speed meter

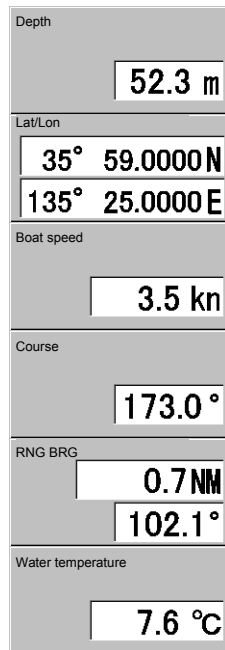

Heading, XTE, Time required, Wind dir., Wind speed, Depth, Lat/Lon, Boat speed, Course, RNG BRG, Water temp

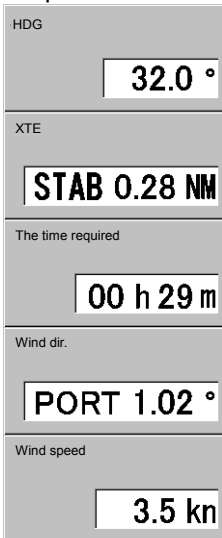

### Selection of NAV Menu

- 1 Press the [DISP] key.
- 2 Select the [NAV1] or the [NAV2]. (Press the [▲] key or [▼] key)
- 3 [NAV1] is displayed at the right side.

Disp	NAV1
NAV1	Display1
Normal (H)	Display2
Zoom (H)	Display3
Dual freq	Display4
Zoom (L)	
Normal (L)	
NAV2	

- 4 Press the [▶] key.
- 5 Select either one of [Display1] to [Display4] by operating [▲] or [▼] key. At the locations where Display of NAV is shown, a numerical figure ①, ②, ③ or ④ is indicated. (The figure below is the case where [Display 1] is selected).

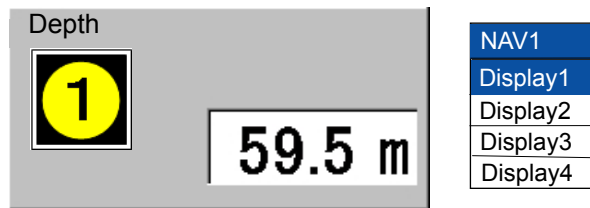

**Caution:** When simple plotter, speed meter or compass is displayed on the screen, [Display2] and [Display4] cannot be selected.

- 6 Press the [▶] key.
- 7 Select the [Display1]. (Press the [▲] key or [▼] key.)

Display1
Simple plotter
Compass
Speed meter
Depth
Lat/Lon
Boat speed
Course

- 8 Press the [MENU] key to close the menu.

## 1.6 Switch-over of Range

The range of measured depth displayed on the display can be changed.

To meet your purpose, select the range of measured depth.

### Setting the range switching to auto range

By following automatically the bottom, the image of echo sounder in the suitable range of measured depth can be displayed.

This mode is convenient to display always the range from sea level to bottom.

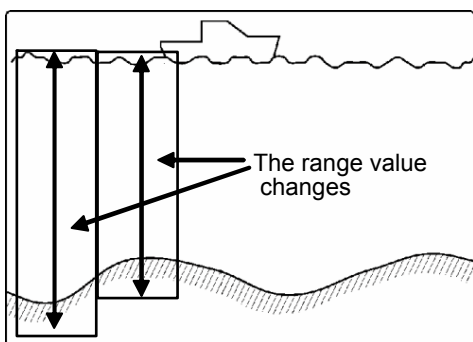

- 1 Press [▲] or [▼] key of [▲RANGE▼].
- 2 Select the [Auto Range]. (Press [▲] or [▼] key of [▲RANGE▼])

Range	
[▲]	Auto range
	5.0
	10.0
	20.0
	50.0
	100
	160
	300
	500
	Auto shift
	[▼]

- 3 Press [MENU] to close the menu. When [Auto Range] is set, the [R:A] is displayed at the upper side of menu.

**Caution:** At auto range, this sounder can sound the area up to the maximum sounding registered. The maximum range is 800 m. At the initial setup, the range is up to 200 m for CVS-128 and up to 500 m for CVS-128B. (See [3.6 Setting of Adujust2 Item, Sounding])

### Setting the range switching to Manual range

The range can be manually selected:

- 1 Press [▲] or [▼] key of [▲RANGE▼].
- 2 Select the range you desire to set. (Press [▲] or [▼] key of [▲RANGE▼])

Range	
[▲]	Auto range
	5.0
	10.0
	20.0
	50.0
	100
	160
	300
	500
	Auto shift
	[▼]

- 3 Press the [MENU] key to close the menu. When the [Manual] is set, the [R: M] is displayed at the upper side of menu.

## 1.7 Setting of Shift

The [Shift] (Manual Shift) and [Auto Shift] are provided.

### Manual Shift (Shift):

The image range is shifted up and down. (Setting: m, fm, l.fm: 0 ~ 300, ft: 0 ~ 1000)

**Caution:** Only when the [shift] is registered in [F1] key or [F2] key, it is effective. It is invalid when not registered. (See [1.10 Use of [F1] / [F2] key])

**Caution:** When the equipment is shipped from the factory, the [shift] is registered in the [F2] key.

### Auto Shift:

The image is automatically shifted so that the bottom is always displayed.

### Setting of Manual Shift

The scope of range starting with the shift value is displayed.

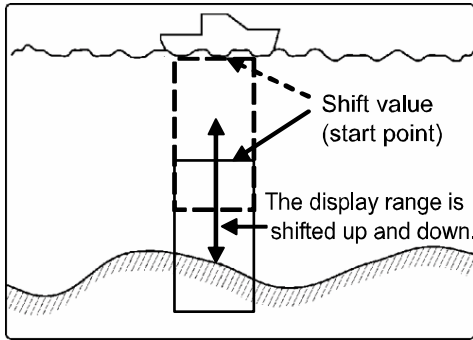

- 1 Press [F2] key twice. The shift function is turned on.

Shift
OFF
ON

- 2 Press the [MENU] key to close the menu.
- 3 Press the [▲] key or [▼] key.
- 4 Change the set value of [Shift]. (Press the [▲] key or [▼] key)

Shift
10

- 5 Press the [MENU] key to close the menu.

**Caution:** This operation cannot be done while an auto range or auto shift is working.

### Release of manual Shift

The shift function is released, and it returns it to former screen.

- 1 Press twice the [F2] key. The shift function is turned off.

Shift
OFF
ON

- 2 Press the [MENU] key to close the menu.

### Setting of Auto Shift

The image is automatically shifted so that the bottom is always displayed.

- 1 Press [▲] of [▼] key of [▲RANGE▼].
- 2 Select the [Auto shift] (Press [▲] of [▼] key of [▲RANGE▼])

Range
Auto range
5.0
10.0
20.0
50.0
100
160
300
500
Auto shift

Range
40.0

- 3 Press the [▶] key.

Range
Auto range
5.0
10.0
20.0
50.0
100
160
300
500
Auto shift

Range
40.0

- 4 Select a range at [Auto shift]. (Press the [▲] key or [▼] key)
- 5 Press the [MENU] key to close the menu. When the [Auto shift] is set, the [R : AS] is displayed at the upper side of menu.

## 1.8 Gain Adjustment

The gain can be adjusted in the auto mode [Cruising, Fishing] or manual mode.

### [Cruising]

Eliminating the weak echo, it displays clearly the sea bottom of strong echo. It is suitable for cruising to the fishery ground.

### [Fishing]

It displays clearly the weak echo reflected from the school of fish. It is suitable for searching the schools of fish.

### Basic Operation of Gain

When [GAIN (HF) Knob] or [GAIN (LF) Knob] is pressed twice, the screen of [Gain select] is displayed.

By rotating the [GAIN (HF) Knob] or [GAIN (LF) Knob], the gain adjustment or auto gain can be selected.

**Caution:** The high frequency can be set by [GAIN (HF) Knob] and the low frequency can be set by [GAIN (LF) Knob].

**Caution:** When only high frequency is displayed, no gain adjustment at low frequency is available. When only low frequency is displayed, no gain adjustment at high frequency is available.

### Selecting the auto gain

When the [Cruising] or [Fishing] is set, the gain can be fine-adjusted.

- 1 Press [GAIN (HF) Knob] twice, and [Gain select] is displayed. (The high frequency is explained below.)

**Caution:** The low frequency can be set by [GAIN (LF) Knob].

- 2 Select the [Cruising] or [Fishing] by rotating the [Knob].

Gain select
Manual
Cruising
Fishing

- 3 Press the [MENU] key to close the menu. When the [Cruising] is set, the [L: AC] [H: AC] is displayed at the upper side of menu. When the [Fishing] is set, the [L: AF] [H: AF] is displayed at the upper side of menu.

### Adjusting the gain by auto

The auto gain adjustment can be set to [Auto adjust high] or [Auto adjust low]. (Setting:-30 ~ 10)

- 1 Turn [GAIN (HF) Knob], and [Auto adjust high] is displayed. (The high frequency is explained below.)

**Caution:** The low frequency can be set by [GAIN (LF) Knob].

- 2 Fine-adjust the gain by rotating the [GAIN (HF) Knob]. The [Cursor] key menu position can be moved.

Auto adjust high
0

- 3 Every time when [GAIN (HF) Knob] is pressed, the [Gain select] and [Auto adjust high] are alternately displayed.
- 4 Press the [MENU] key to close the menu.

### Selecting the manual gain

Adjustment of gain can be done manually.

- 1 Press [GAIN (HF) Knob] twice, and [Gain select] is displayed. (The high frequency is explained below.)

**Caution:** The low frequency can be set by [GAIN (LF) Knob].

- 2 Select the [Manual] by rotating the [Knob].
- 3 Press the [MENU] key to close the menu.

### Manual adjustment of the gain

When only the image of High frequency is displayed, the High frequency gain can be adjusted. (Setting: 0 to 10)

When only the image of Low frequency is displayed, the Low frequency gain can be adjusted.

**Caution:** If you increase the gain too much, noise will appear on the entire image, resulting in an unclear image. Adjust properly the gain so that the optimum image can be always displayed.

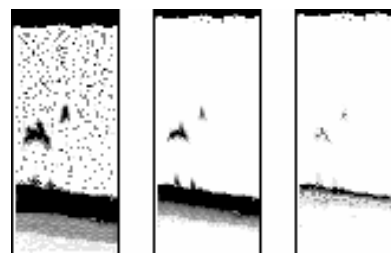

Over-gain      Optimum      Under-gain

- 1 Turn [GAIN (HF) Knob] to display [Auto adjust high]. (The high frequency is explained below.)

**Caution: The low frequency can be done by [GAIN (LF) Knob].**

- Adjust the gain by rotating the [Knob]. The [Cursor] key menu position can be moved.

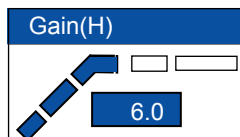

Stop increasing of the gain just before noise appears on the image.

- Every time when [GAIN (HF) Knob] is pressed, the [Gain select] and [Gain (H)] are alternately displayed.
- Press the [MENU] to close the menu.

The latest set value of frequency (High frequency or Low frequency) adjusted is displayed at the upper left side of menu.

Example:

The High frequency gain is 8.0 → H: 8.0.



### 1.9 Use of [EVENT] key

By pressing the [EVENT] key, three functions of [Store Position], [Store Image] and [Fishing hot spot] are available.

The fishing hot spot is the function to instruct your boat to navigate easily to a point where you desire to go back.

[Store pos]: The latitude and longitude of a point can be stored in the destination list.

[Store image]: An image of the echo sounder can be stored in the internal memory.

[Fishing hot spot]: The WPT navigation starts, using the latitude and longitude of a point which is set as a destination by pressing the [EVENT] key. Simultaneously, the latitude and longitude of the point can be stored in the destination list.

**Caution: Requires position data from GPS sensor.**

#### Selecting the event key function

Select the functions when pressing the [EVENT] key.

- Press the [MENU] key.
- Select [System] → [EVENT Key set]. (Press the [▶] key or [▲] key or [▼] key) (See [2.1

How to operate the menu))

- Press the [▶] key.
- Change the setting of [EVENT key set]. (Press the [▲] key or [▼] key)

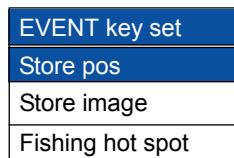

- Press the [MENU] to close the menu.

#### Presetting the waypoint

When you find the school of fish or tide, its location can be preset as a waypoint. (10 locations at maximum)

When presetting the waypoint, switch [System] → [EVENT Key set] → [Store pos]. (See [1.9 Use of [EVENT] key Selecting the event key function])

- In the state that no other key is pressed, press the [◀] key or [▶] key.
- Move the cursor (red line) with the [◀] key or [▶] key to the location to be preset as a waypoint.

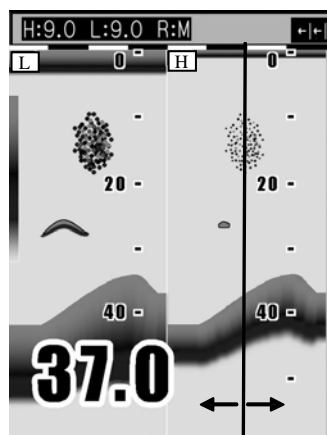

Cursor (Red line)

- Press the [EVENT] key. When decided, the red line is drawn at the designated location on the echo sounder menu and the latitude and longitude of designated location are registered in the waypoint list. At this moment, the list number of preset waypoint is displayed.

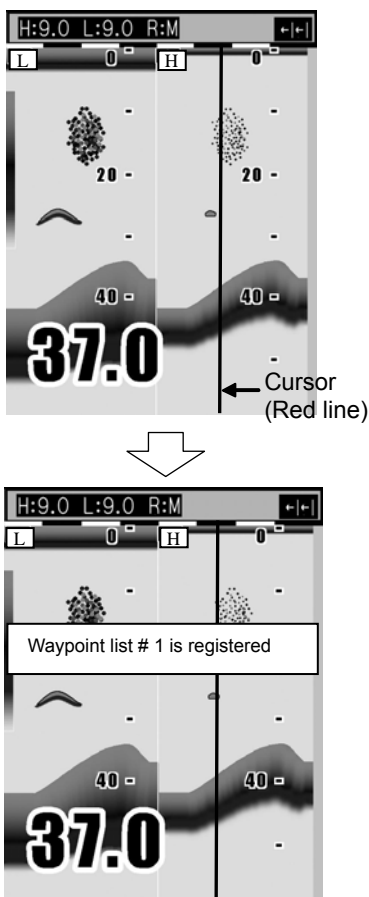

- 4 After a certain time passes, the message disappears and presetting the waypoint is finished.

**Caution:** When pressing the [EVENT] key, if [In out] → [NMEA output data] → [TLL] is set to ON, the latitude and longitude of location above-designated is output to the navigation system connected.

**Caution:** If the waypoint list is full, the preset destination list is not deleted, showing the message that the list is fully filled. After a certain time passes, the message disappears.

A waypoint list is full.  
Registration is not completed

**Caution:** If the waypoint list is full, delete an unnecessary waypoint from the waypoint list.

### Store the image

When you find the schools of fish, its location can be stored as a waypoint. (10 locations at maximum)

When storing the image, switch [NAV] → [EVENT Key set] → [Store pos]. (See [1.9 Use of [EVENT] key Selecting the event key function].)

- 1 Press the [EVENT] key.

Processing is displayed.

- 2 After a certain time passes, the image of echo sounder presently displayed is stored and the list number of stored image is displayed.

Image data list # 1 is registered

- 3 After a certain time passes, the message disappears and storing the image is finished.

**Caution:** If the waypoint list is fully filled, the preset destination list is not deleted, showing the message that the image is fully filled. After a certain time passes, the message disappears.

A list of Pic is full.  
Registration is not completed.

**As for deletion and recall of images, see [2.15 Store/Recall/Deletion of image].**

### Fishing hot spot

Leads you back to your favorite fishing hot spots or other previously stored positions in memory with input from optional GPS sensor. (See [2.14 Preset/ WPT edit/ WPT delete of Waypoint])

To perform the fishing hot spot, it is necessary to select [System] → [EVENT key set] → [Fishing hot spot]. (See [1.9 Use of [EVENT] key Selecting the event key function].)

- 1 In the state that no other key is pressed, press the [◀] key or the [▶] key.
- 2 Move the cursor (red line) to a point you desire to go back with the [◀] key or [▶] key.



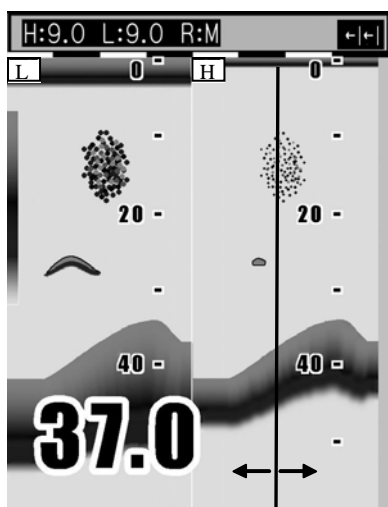

Cursor (Red line)

- 3 Press the [EVENT] key.  
When you decide, the red line is drawn on the image of the echo sounder at the point you designate and the latitude and longitude of the point you designate is stored in the destination list.  
At this moment, the number of the stored destination list is displayed.
- 4 The navigation display (NAV1) is displayed and the WPT navigation starts.

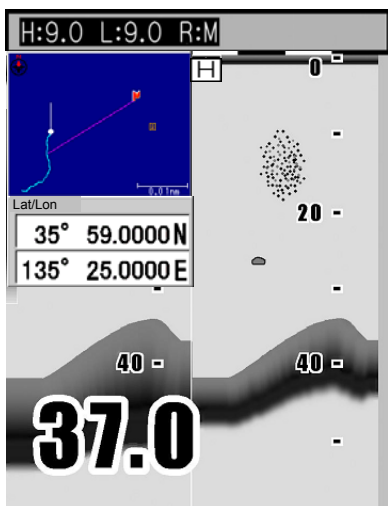

**Note:** The display of NAV1 is displayed.

- 5 To stop the fishing hot spot, cancel destination navigation. (See: [2.14 Preset/ WPT edit/ WPT delete of Waypoint], [Cancel the NAV].)

## 1.10 Use of [F1] / [F2] key

At ex-factory, the [Image Speed] is assigned to the [F1] key, and the [Shift] is assigned to the [F2] key. The function settable to the [F1]/[F2] key can be selected among [Image Speed], [IR], [Color Rejection], [Noise Rejection], [Shift], [Zoom Range], [Zoom Start], [A scope], [White line], [Background color], [Disp width], [Nav start], [NAV1], [NAV2], [Image swap], [Image recall] and [Sona-tone]. Set the function frequently used for your convenience.

### Selecting the [F1]/[F2] key

- 1 Press the [F1] key or [F2] key.
- 2 Select the setting with [▲] key or [▼] key.

#### Example [Image speed]

Image speed
Speed1
Speed2
Speed3
Speed4
Stop
Speed5 (1/1)
Speed6
Speed7
Speed8
Speed9

**! Caution:** When the fish symbol function is made effective, the image speed becomes two kinds ([Speed5 (1/1)] or [Stop]).

- 3 Press the [MENU] key to close the menu.

















### Preset of [F1] / [F2] key

- 1 Press the [MENU] key.
- 2 Select [System] → [F1 key set] or [F2 key set]. (Press the [▶] key or [▲] key or [▼] key.) (See [2.1 How to operate the menu])
- 3 Press the [▶] key.
- 4 Select the function. (Press the [▲] key or [▼] key)



F1 key set
Image Speed
IR
Color Rejection
Noise Rejection
Shift
Zoom Range
Zoom Start
A scope
White line
Background Color

- 5 Press the [MENU] key to close the menu. The icons of functions preset are displayed at the upper right side on the menu.

	← Image speed		← Image recall
	← IR		← Image swap
	← Color rejection		← NAV1
	← Noise rejection		← NAV2
	← Shift		← Disp width
	← Zoom Range		← Sona-tone
	← Zoom Start		
	← A scope		
	← White Line		
	← Background color		

Other than the above operation method. When keep pressing the [F1] key or [F2] key for few second, the key set menu is displayed.

### 1.11 Operation of VRM



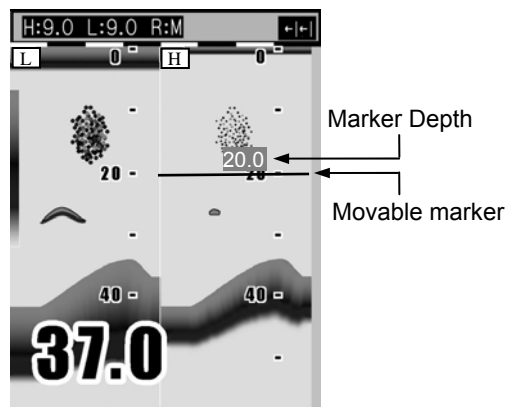

The VRM (movable marker) shown by the green line can be moved up and down.

It is convenient to measure the depth by aligning with the target such as school of fish.

- 1 Press the [▲] key or [▼] key. The movable marker (straight line) is displayed.
- 2 Press the [▲] key or [▼] key. The movable marker moves up and down. The movable marker and the numerical of marker depth are simultaneously highlighted.



When displaying dual images, if the [◀] key or [▶] key is pressed, the movable marker moves to the neighboring image.

-  **Caution: When several seconds pass after finishing the VRM operation, the numerical of marker depth becomes normal display.**
-  **Caution: If VRM is moved to the top of the display, the VRM can be disappeared.**
-  **Caution: VRM can be operated by turning [GAIN (LF) Knob] at the high frequency screen.**
-  **Caution: VRM can be operated by turning [GAIN (HF) Knob] at the low frequency screen.**

### 1.12 Display of fish information





When transducer TD-501C is connected, specific response can be displayed as [Fish symbol].

For detection of fish information, 2 frequencies, 200 kHz and 50 kHz are used.

Only in case echo comes up in both frequencies, the detection can be made.

By [Symbol info], the magnitude and the value of depth of the response can be displayed.

-  **Caution: Fish information is to display the specific responses in an easy way to watch. Displays of [Fish symbol] do not always mean that there is fish there.**

-  **Caution:** The area where [Fish symbol] can be displayed is from 3 m to 100 m. (ft: 10 to 330, fm: 2 to 54, l.fm:2 to 60)
-  **Caution:** [Fish symbol] is not displayed in the range that is deeper than 120m. (ft: 350, fm:60, l.fm:70)
-  **Caution:** When the fish symbol function is made effective, the image speed becomes 2 kinds ([Speed5 (1/1)] or [Stop]).
-  **Caution:** Adjustment is necessary when equipped with Inner-hull. (See [2.17 Explanation of Menu Item, Inner-hull].)

**Display the fish symbol/Stop the display of fish symbol**

- 1 Press the [MENU] key.
- 2 Select [Display1] → [Fish symbol]. (Press the [▶] key or [▲] key or [▼] key.) (See [2.1 How to operate the menu])
- 3 Press the [▶] key.
- 4 Select the symbol to be displayed on the screen. (Press the [▲] key or [▼] key)

Fish symbol
Symbol 1

- 5 Press the [MENU] key to close the menu.
- When this function is effective, the icon  is displayed at the top of the screen.



 **Caution:** When [Fish symbol] on the screen does not always mean that the response shows fish.

**Selecting the symbol info**

[Symbol info] is effective only when [Fish symbol] is displayed.

- 1 Press the [MENU] key.
- 2 Select [Display1] → [Symbol info]. (Press the [▶] key or [▲] key or [▼] key.) (See [2.1 How to operate the menu])
- 3 Press the [▶] key.
- 4 Select the information associated with [Fish symbol] (Press the [▲] key or [▼] key.)

Symbol info
OFF
Depth
Size
Bottom↔Fish



-  **Caution:** The display of [Size] is expressed in cm.
- 5 Press the [MENU] key to close the menu.
-  **Caution:** The magnitude by [Symbol info] would not be always the response from fish. And it may be incorrect due to various environmental conditions. Please take these as reference.
-  **Caution:** The value of depth by [Symbol info] would not be always the response from fish. That shows the point that there was specific response.

**Fish symbol detection adjustment**

Detection of fish marks can be adjusted.

Select [Correct] → [Detect adjust f].

Fish marks are hardly displayed. (Error in detection is less)	← 1 2 3 4 5 6 →	Fish marks are easily displayed. (More possible false detections)
---	-----------------	---

-  **Caution:** If the larger the set values become, the more fish marks can be displayed with more false detections.
-  **Caution:** For Through-hull installation, adjust between 1 and 4. For Inner-hull installations, adjust between 3 and 6.

**Size adjustment**

The indicated size of fish marks can be adjusted.

Please correct the size when the indicated value is different from the fish that actually caught.

Select [Correct] → [Size adjust].

Values of indicated size will be decreased.	← 1 2 3 4 5 6 7 8 9 10 →	Values of indicated size will be increased.
---	--------------------------	---

The indicated size will change by approximately 10 to 20 percent of the value, per one setting value.

 **Caution:** When the value of [Detect adjust f] is set at 5 or 6, the size of fish can not be specified and there may be cases where no numerical figures are displayed or only "----" is displayed. When there is no display of numerical figures, it is judged that fish are too small. When "---" is displayed, it is judged that fish is too big.

### Big fish / Big fish color

The fish bigger than the set value [cm] is specified as big fish.

Select keys of [Display2] → [Big fish].

Colors for values of big fish can be assigned.

Select keys of [Display2] → [Color table 2] → [Big fish color].

### Points to note in use of fish symbol

The values displayed by this function may be incorrect depending on various environmental conditions. In use of these values, please understand the following factors of error, and use them as reference:

#### **[Factors of error]**

- 1** When there are overlapping responses, all of them may be displayed to show the magnitude of a point.
- 2** The strength of reflection may depend on the output of transducer unit and may result in a factor of error.
- 3** The strength of reflection may depend on the kind of fish and may result in a factor of error. As for the fish such as the squid which don't have an air bladder, the error is big.
- 4** Fish banks, fishing net, fishing equipment, air bubbles and floating objects, etc. may be detected and displayed.
- 5** When the transducer unit is mounted in inner-hull, there may be cases where response cannot be detected depending on attenuation, and large error may be generated.
- 6** The strength of reflection may depend on the difference of ship handling such as stoppage and cruising, and may result in a factor of error.
- 7** Each transducer unit may have difference in transmission/receiving performance to cause error.
- 8** When there is dirt in the sea and the plankton layers have been generated, it becomes the factor of the error margin.

## Chapter 2 How to use the menu

### 2.1 How to operate the menu

#### Display the menu/Stop the display of menu

- 1 Press the [MENU] key.  
The menu and explanation of operation are displayed.

Name of menu selected	Menu column	Setting item	Cursor column	Setting value
Adjust	Image speed	Speed	5	
D.range	IR		Strong	
Display1	Color rejection		0%	
Display2	Noise rejection		0	
Alarm1	TVG		Medium	
Alarm2	TX power		Auto	
NAV	Gain (TD)			
Image	Pulse width*		Middle	
System	Band width*		Middle	
Freq*	D.Range*		24dB	
Next	Return			

\* For CVS-128B

Guide
-------

It is displayed when the [Operation Guide] is set to ON.

(See [2.17 Explanation of Menu Item Display the operation guide / Stop the display of operation guide].)

- 2 Press the [MENU] key.  
The menu and explanation of operation close.

#### Menu Operation

- 1 When the menu is displayed, press the [▲] key or [▼] key to select the menu name. Depending on the selected menu name, the content in the set item column at the right side changes. (The menu name can be selected by rotating the [GAIN (HF) Knob] or [GAIN (LF) Knob].)

Adjust	Shift step	1m
D.range	Zoom type	Bottom
Display1	Zoom range	10.0m
Display2	Zoom start	0m
Alarm1	Disp width	Center
Alarm2	Range preset	
NAV	Return	
Image		
System		
Freq*		
Next		

\* For CVS-128B

- 2 Press the [▶] key.  
The cursor appears in the set item column. (The cursor appears by pressing the [GAIN (HF) Knob] or [GAIN (LF) Knob].)
- 3 Select the set item you desire to change with the [▲] key or [▼] key. (The set item can be selected by rotating the [GAIN (HF) Knob] or [GAIN (LF) Knob].)

Adjust	Shift step	1m
D.range	Zoom type	Bottom
Display1	Zoom range	10.0m
Display2	Zoom start	0m
Alarm1	Disp width	Center
Alarm2	Range preset	
NAV	Return	
Image		
System		
Freq*		
Next		

\* For CVS-128B

- 4 Press the [▶] key.  
The set menu corresponding to the selected item is displayed. (It can be displayed by rotating the [GAIN (HF) Knob] or [GAIN (LF) Knob].)

Zoom range
10.0
m

- 5 Change the set content with the [▲] key or [▼] key. (It can be changed by rotating the [Knob])
- 6 Press the [◀] key.  
The cursor returns to the set item column.

(It can be displayed by rotating the [GAIN (HF) Knob] or [GAIN (LF) Knob])

- 7 To select the other menu item, press the [◀] key.  
The cursor returns to the menu column.
- 8 Press the [MENU] key to close the menu.

## 2.2 Changing of Image Speed

The image speed of echo sounder can be changed. Even if the schools of fish and bottom are same, the image changes depending on the image speed.

The image speed becomes slow in the order of [Speed1] → [Speed2] → … → [Speed9].  
When [stop] is selected, the image stops.

**⚠ Caution: When the fish symbol function is made effective, the image speed becomes 2 kinds ([Speed5 (1/1)] or [Stop]).**

- 1 Press the [MENU] key.
- 2 Select the [Adjust] → [Image Speed]. (See [2.1 How to operate the menu].)
- 3 Press the [▶] key.
- 4 Change the setting of [Image Speed]. (Press the [▲] key or [▼] key.)

Image speed
Speed 1
Speed 2
Speed 3
Speed 4
Stop
Speed 5 (1/1)
Speed 6
Speed 7
Speed 8
Speed 9

- 5 Press the [MENU] key to close the menu.

## 2.3 Rejection of Interference

### Interference Rejection

The interference noise from the echo sounder of other boats can be reduced.

If a neighboring boat uses the echo sounder having the same frequency and pulse transmission rate as those your boat has, the interference noise may be displayed. If you set the interference rejection, the interference noise can be reduced. In the order of weak → strong, the noise rejection capability becomes high.

The difference of images based on the different settings of [Interference reduction]

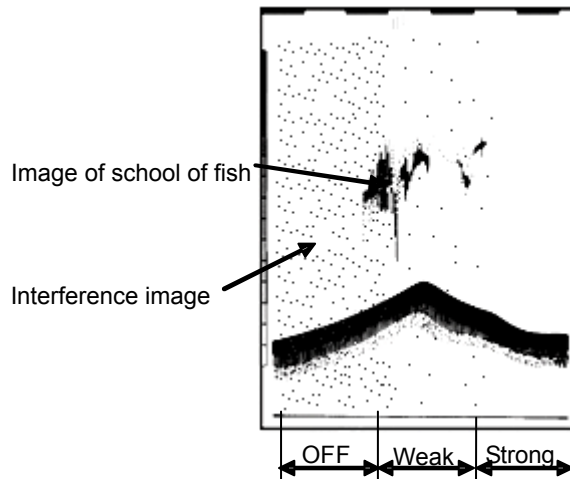

- 1 Press the [MENU] key.
- 2 Select the [Adjust] → [Interference Rejection]. (See [2.1 How to operate the menu].)
- 3 Press the [▶] key.
- 4 Change the setting of [Interference Rejection]. (Press the [▲] key or [▼] key.)

IR
OFF
Weak
Strong

- 5 Press the [MENU] key to close the menu.

## 2.4 Color Rejection of Weak Echo

### Color Rejection

The color of weak echo can be rejected.

Rejecting noise on the entire image and weak echo around the school of fish makes it easier to see the school of fish. It is the convenient function when displaying the echo stronger than the specific signal. (Setting: 0 to 50 %)

- 1 Press the [MENU] key.
- 2 Select the [Adjust] → [Color Rejection]. (See [2.1 How to operate the menu])
- 3 Press the [▶] key.
- 4 Change the setting of [Color Rejection]. (Press the [▲] key or [▼] key.)

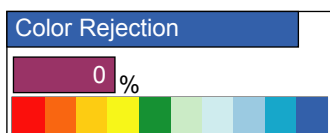

- 5 Press the [MENU] key to close the menu.

## 2.5 Rejection of Noise

### Noise Rejection

The influence of noise can be reduced.

Due to echo reflected from plankton and trash, the speck-like noise may appear on the entire image. Setting the [Noise rejection] reduces the speck-like noise and makes it easier to see the image of school of fish. (Setting: 0 to 10)

The greater the set value becomes, the stronger the effect of noise rejection becomes.

- 1 Press the [MENU] key.
- 2 Select [Adjust] → [Noise rejection]. (See [2.1 How to operate the menu])
- 3 Press the [▶] key.
- 4 Change the setting of [Noise rejection]. (Press the [▲] key or [▼] key)

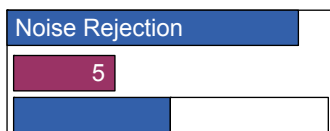

- 5 Press the [MENU] key to close the menu.

## 2.6 Setting of Shift step

The shifting range is set by pressing the [▲] key or [▼] key one time. (Setting range: 1m, 10m, 1/8, 1/4)

- 1 Press the [MENU] key.
- 2 Select the [D.range] → [Shift step]. (See [2.1 How to operate the menu])
- 3 Press the [▶] key.
- 4 Change the setting of [Shift step]. (Press the [▲] key or [▼] key.)

Shift step
1m
10m
1/8
1/4

- 5 Press the [MENU] key to close the menu.

**Caution:** When the shift is set to 1/4 with 100m range, it shifts by 25m.

## 2.7 Selection of Zoom

Set the zoom display with the display mode ([zoom (H)] or [zoom (L)]).

The [Bottom], [Bottom Discrimination], [Zoom], [[Bottom Zoom] and [Bottom Follow Zoom] are provided. (See [1.4 Switch-over of Menu])

- 1 Press the [MENU] key.
- 2 Select [D.range] → [Zoom type]. (See [2.1 How to operate the menu])
- 3 Press the [▶] key.
- 4 Select the zoom type. (Press the [▲] key or [▼] key)

Zoom type
<b>BTM.</b>
B.D.
Zoom
B.Z.
B.F.Z.

5 Press the [MENU] key to close the menu.

For each zoom display, refer to [1.4 Switch-over of Display mode].

## 2.8 Setting of Zoom Range

Set the zoom range in each mode of [BTM], [Bottom Discrimination], [Zoom], [Bottom Zoom] and [Bottom Follow Zoom]

The zoom range of each mode is identical.

(See [1.4 Switch-over of Display mode])

(Setting: m: 2.5 to 200, fm, l.fm: 2.5 to 150, ft:10.0 to 650)

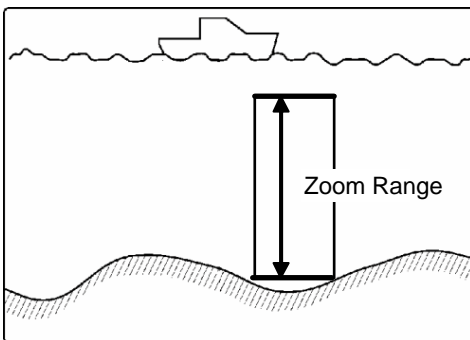

- 1 Press the [MENU] key.
- 2 Select [D. range] → [Zoom range]. (See [2.1 How to operate the menu])
- 3 Press the [▶] key.
- 4 Change the set value of [Zoom range]. (Press the [▲] key or [▼] key)

Zoom Range
<b>10.0</b> ▲▼
m

5 Press the [MENU] key to close the menu.

## 2.9 Setting of Zoom Start

Select the zoom start in the [Zoom].

(See [1.4 Switch - over of Display mode])

(Setting: m: 0 to 800, fm, l.fm: 0 to 500, ft: 0 to 2600)

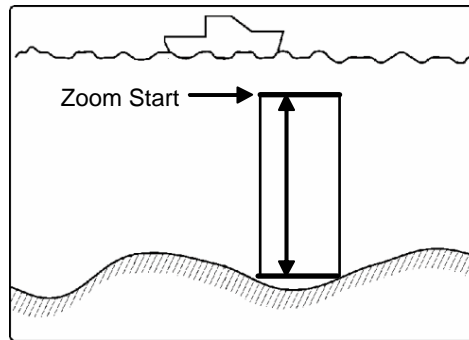

- 1 Press the [MENU] key
- 2 Select [D. range] → [Zoom start] (See [2.1 How to operate the menu])
- 3 Press the [▶] key.
- 4 Change the set value of [Zoom start]. (Press the [▲] key or [▼] key)

Zoom start
<b>10</b> ▲▼
0-800 m

5 Press the [MENU] to close the menu.

## 2.10 Preset of Range

The range switched with the [▲RANGE▼] key can be set.

Preset the set value suitable for your purpose.

(Setting range: m: 2.5 to 1200, fm, l.fm: 2.5 to 700, ft: 10 to 3600)

- 1 Press the [MENU] key.
- 2 Select [D.range] → [Range preset] → [Range 1 to 8]. (See [2.1 How to operate the menu])
- 3 Press the [▶] key.

- 4 Select [Range 1 to 8]. (Press the [▲] key or [▼] key)

Adjust	Prev	
D.range	Range 1	5.0 m
Disp1	Range 2	10.0 m
Disp2	Range 3	20.0 m
Alarm1	Range 4	50.0 m
Alarm2	Range 5	100 m
NAV	Range 6	160 m
Image	Range 7	300 m
System	Range 8	500 m
Freq*	Return	
Next		

\* For CVS-128B

**Caution:** Select [Forward], and press [▶] key to return to the previous menu.

- 5 Press the [▶] key.
- 6 Select the set value of [Range 1 to 8]. (Press the [▲] key or [▼] key)

Range1	5.0	▲▼
		m

- 7 Press the [MENU] key to close the menu.

### Easy registration method of the range

- 1 Press [▲] or [▼] key of [▲RANGE▼].
- 2 Change the range you desire to set. (Press [▲] or [▼] key of [▲RANGE▼])

	Range	
[▲]	Auto range	
▲	5.0	
	10.0	
	20.0	
	50.0	
	100	
	160	▼
	300	
	500	
	Auto shift	

- 3 Press the [▶] key.
- 4 Select the set value of Range. (Press the [▲] key or [▼] key)

Range1	5.0	▲▼
		m

- 5 When the [◀] key is pressed, it returns to the [range]. Other detecting range can be continuously changed.
- 6 Press the [MENU] key to close the menu.

### 2.11 Setting of Background Color

Responding to the ambient brightness, the background color of display can be changed.

- 1 Press the [MENU] key.
- 2 Select [Display1] → [Background color]. (See [2.1 How to operate the menu])
- 3 Press the [▶] key.
- 4 Change the setting of [Background color]. (Press the [▲] key or [▼] key)

Background color
Pale blue
Marine blue
Blue
Dark blue
Black
Darkkhaki
Mediumseagreen
Light grey
White
Night mode

- 5 Press the [MENU] to close the menu.

### 2.12 Setting of White Line

As the surface of bottom is marked with the white line of constant width, the school of fish at the bottom can be easily identified.



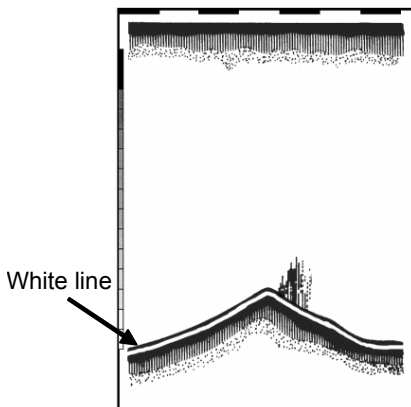

- 1 Press the [MENU] key
- 2 Select [Display1] → [White line]. (See [2.1 How to operate the menu])
- 3 Press the [▶] key.
- 4 Change the setting of [White line].  
 "1" is narrowest. "5" is widest.  
 In the auto mode, responding to the strength of echo reflected from the bottom, the width of white line changes. (Press the [▲] key or [▼] key)

White line
OFF
1
2
3
4
5
Auto

- 5 Press the [MENU] key to close the menu.

## 2.13 Setting of Alarm

6 alarms of bottom alarm, fish alarm, water temp alarm, speed alarm, arrival alarm and XTE alarm can be set.

They are notified by alarm sound and alarm display.

[Bottom alarm] issues the alarm when the position recognized as the bottom is shallower than the upper limit or deeper than the lower limit. It is convenient when keeping the specific depth. (Setting: m: 0 to 800, fm, l.fm: 0 to 700, ft: 0 to 2800)

[Fish alarm] issues the alarm when an echo recognized as school of fish exists in the set

range. It is convenient for you to judge whether the echo of school of fish is present or not. (Setting: m: 1 to 800, fm, l.fm: 1 to 700, ft: 1 to 2800)

**⚠ Caution: In the [Level], select the strength of echo reflected from the schools of fish in the [Fish alarm].**

[Water temp alarm] issues when the water temp is within or out of the set range. It is convenient to keep the specific water temp region. (Setting: - 5 to 45 °C, 23 to 113 °F)

[Speed alarm] issues when the boat speed is faster or slower than the set range. It is convenient when the speed limit is obliged. (Setting: 0 to 80 kn, 0 to 148 km/h)

[Arrival alarm] can be used in the state that the destination is set. The alarm is issued when your boat arrives within a certain range of destination. A certain range is set in the [NAV alarm range]. (See [1.9 Use of [EVENT] key.]

[XTE alarm] can be used in the state that the destination is set. The alarm is issued when your boat is off a certain distance from the course on the line drawn straightly from destination to the location when setting the destination. A certain distance is set in the [NAV alarm range].

**⚠ Caution: In the [NAV alarm range], select the alarm range of [Arrival alarm] and [XTE alarm]. (Setting: 5 to 999 m)**

**⚠ Caution: The setting range of [Arrival alarm] and [XTE alarm] can not be separately set.**

### Stopping the alarm sound

To stop the alarm sound and the alarm display, press [MENU] key.

### Setting the alarm

Adjust	Bottom alarm	OFF
D.range	Upper depth	5m
Disp1	Lower depth	50m
Disp2	Fish alarm	OFF
Alarm1	Position	5m
Alarm2	Range	50m
NAV	Level	Medium
Image	Return	
System		
Freq*		
Next		

Adjust	Water temp alarm	OFF
D.range	Upper temp alarm	20.0°C
Disp1	Lower temp alarm	15.0°C
Disp2	Speed alarm	OFF
Alarm1	Speed limit	0kn
Alarm2	Arrival alarm	OFF
NAV	XTE alarm	OFF
Image	NAV alarm range	10m
System	Return	
Freq*		
Next		

\* For CVS-128B

- 1 Press the [MENU] key.
- 2 Select your desired alarm from [Alarm 1] or [Alarm 2]. (See [2.1 How to operate the menu].)
- 3 Press the [▶] key.
- 4 Select the [ON] of alarm you desire. (Press the [▲] key or [▼] key)
- 5 If the setting of [Alarm range] is provided in the alarm desired, select the alarm range. (See [2.1 How to operate the menu])
- 6 Change the set value of alarm range. (Press the [▲] key or [▼] key)
- 7 Press the [MENU] key to close the menu.

### Release the alarm

- 1 Press the [MENU] key.
- 2 Select the alarm to be released from [Alarm 1] or [Alarm 2]. (See [2.1 How to operate the menu])
- 3 Press the [▶] key.
- 4 Select the [OFF] of alarm to be released. (Press the [▲] key or [▼] key)
- 5 Press the [MENU] key to close the menu.

### Confirm the alarm state

The set state of [Bottom alarm] and [Fish alarm] can be confirmed on the bar at the right corner of display. However, when the display is out of the range, they are not displayed.

When [Water temp alarm], [Speed alarm], [Arrival alarm] or [EXT alarm] is ON, the corresponding icon is displayed at the upper side of the screen.

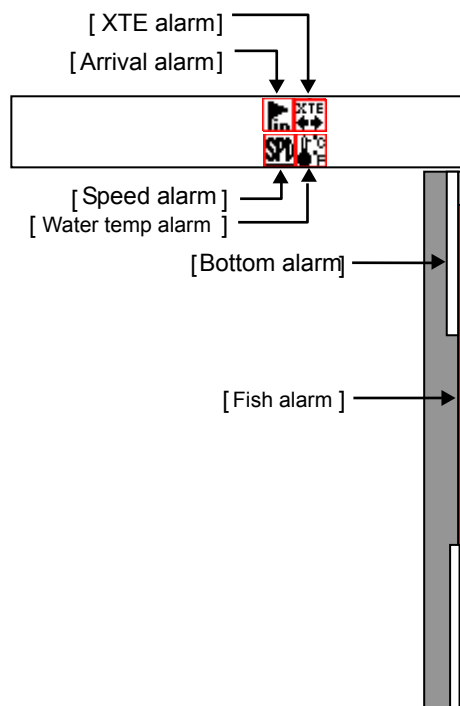

## 2.14 Preset/WPT edit/WPT delete of Waypoint

### NAV Start

The NAV can be started by selecting the destination from the destination list.

To perform the NAV start, the destination must be preset. (See [1.9 Use of [EVENT] key])

**Caution: Requires position data from GPS sensor.**

- 1 Press the [MENU] key.
- 2 Select [NAV] → [NAV start]. (See [2.1 How to operate the menu])
- 3 Press the [▶] key.
- 4 Select the [Destination list] preset. (Press the [▲] key or [▼] key)

NAV start			
No.	Comment	Lat	Lon
1	WPT00001	XX° XXXX.XXXXN	XXX° XXXX.XXXX E
2	WPT00002	XX° XXXX.XXXXN	XXX° XXXX.XXXX E
3	WPT00003	XX° XXXX.XXXXN	XXX° XXXX.XXXX E
4	WPT00004	XX° XXXX.XXXXN	XXX° XXXX.XXXX E
5	WPT00005	XX° XXXX.XXXXN	XXX° XXXX.XXXX E
6	WPT00006	XX° XXXX.XXXXN	XXX° XXXX.XXXX E
7	WPT00007	XX° XXXX.XXXXN	XXX° XXXX.XXXX E
8	WPT00008	XX° XXXX.XXXXN	XXX° XXXX.XXXX E
9	WPT00009	XX° XXXX.XXXXN	XXX° XXXX.XXXX E
10	WPT00010	XX° XXXX.XXXXN	XXX° XXXX.XXXX E

**Caution: The list No. selected is reversed in yellow.**

- 5 Press the [▶] key.
- 6 Select the [Yes] in the confirmation menu. (Press the [▲] key or [▼] key)

NAV starts
Yes
No

- 7 Press the [MENU] key. Then, the NAV starts.

### Cancel the NAV

The NAV started can be cancelled halfway.

- 1 Press the [MENU] key
- 2 Select [NAV] → [NAV cancel]. (See [2.1 How to operate the menu])
- 3 Press the [▶] key.
- 4 Press the [Yes]. (Press the [▲] key or [▼] key)

NAV cancel
Yes
No

- 5 Press the [MENU] key. Then, the NAV is released.
- 6 To return the display to the original one, the display mode shall be switched over. (See: [1.4 Switch-over of Display mode])

### Edit the destination

By entering the latitude and longitude, the destination can be preset.

The list preset in the past can be edit.

- 1 Press the [MENU] key.
- 2 Select [NAV] → [WPT edit]. (See [2.1 How to operate the menu])
- 3 Press the [▶] key.
- 4 Select the list No. to be edited from the [WPT edit] list. (Press the [▲] key or [▼] key)

WPT edit			
No.	Comment	Lat	Lon
1	WPT00001	XX° XXXX.XXXXN	XXX° XXXX.XXXX E
2	WPT00002	XX° XXXX.XXXXN	XXX° XXXX.XXXX E
3	WPT00003	XX° XXXX.XXXXN	XXX° XXXX.XXXX E
4	WPT00004	XX° XXXX.XXXXN	XXX° XXXX.XXXX E
5	WPT00005	XX° XXXX.XXXXN	XXX° XXXX.XXXX E
6	WPT00006	XX° XXXX.XXXXN	XXX° XXXX.XXXX E
7	WPT00007	XX° XXXX.XXXXN	XXX° XXXX.XXXX E
8	WPT00008	XX° XXXX.XXXXN	XXX° XXXX.XXXX E
9	WPT00009	XX° XXXX.XXXXN	XXX° XXXX.XXXX E
10	WPT00010	XX° XXXX.XXXXN	XXX° XXXX.XXXX E

- 5 Press the [▶] key.
- 6 Select the character with the [▲] key or [▼]

key. (Character: A ~ Z, blank, 0 ~ 9, +, -./  
Lat/Lon: 0~9,N,S,E,W)

WPT edit			
No.	Comment	Lat	Lon
1	WPT00001	XX° XXXX.XXXXN	XXX° XXXX.XXXX E
2	WPT00002	3X° XXXX.XXXXN	XXX° XXXX.XXXX E
3	WPT00003	XX° XXXX.XXXXN	XXX° XXXX.XXXX E
4	WPT00004	XX° XXXX.XXXXN	XXX° XXXX.XXXX E
5	WPT00005	XX° XXXX.XXXXN	XXX° XXXX.XXXX E
6	WPT00006	XX° XXXX.XXXXN	XXX° XXXX.XXXX E
7	WPT00007	XX° XXXX.XXXXN	XXX° XXXX.XXXX E
8	WPT00008	XX° XXXX.XXXXN	XXX° XXXX.XXXX E
9	WPT00009	XX° XXXX.XXXXN	XXX° XXXX.XXXX E
10	WPT00010	XX° XXXX.XXXXN	XXX° XXXX.XXXX E

- 7 Move the position of characters to be reversed with the [◀] key or [▶] key.

WPT edit			
No.	Comment	Lat	Lon
1	WPT00001	XX° XXXX.XXXXN	XXX° XXXX.XXXX E
2	WPT00002	35° XXXX.XXXXN	XXX° XXXX.XXXX E
3	WPT00003	XX° XXXX.XXXXN	XXX° XXXX.XXXX E
4	WPT00004	XX° XXXX.XXXXN	XXX° XXXX.XXXX E
5	WPT00005	XX° XXXX.XXXXN	XXX° XXXX.XXXX E
6	WPT00006	XX° XXXX.XXXXN	XXX° XXXX.XXXX E
7	WPT00007	XX° XXXX.XXXXN	XXX° XXXX.XXXX E
8	WPT00008	XX° XXXX.XXXXN	XXX° XXXX.XXXX E
9	WPT00009	XX° XXXX.XXXXN	XXX° XXXX.XXXX E
10	WPT00010	XX° XXXX.XXXXN	XXX° XXXX.XXXX E

**Caution:** If the values of latitude and longitude are not entered, they are registered as 0.

- 8 To end editing, press [GAIN (HF) Knob] or [GAIN (LF) Knob].  
9 After finishing the edit work, press the [MENU] key.  
10 Select the [registered] in the confirmation menu.

Edit end
Registered
Not registered

- 11 Press the [MENU] key. Then, the edit is finished.

### Delete the waypoint

The destination list preset in the past can be deleted.

The deletion takes some time.

- 1 Press the [MENU] key.
- 2 Select [NAV] → [WPT delete]. (See [2.1 How to operate the menu])
- 3 Press the [▶] key.
- 4 Select the list number of destination to be deleted from the [WPT delete]. (Press the [▲] key or [▼] key)

WPT delete			
No.	Comment	Lat	Lon
1	WPT00001	XX° XXXX.XXXXN	XXX° XXXX.XXXX E
2	WPT00002	XX° XXXX.XXXXN	XXX° XXXX.XXXX E
3	WPT00003	XX° XXXX.XXXXN	XXX° XXXX.XXXX E
4	WPT00004	XX° XXXX.XXXXN	XXX° XXXX.XXXX E
5	WPT00005	XX° XXXX.XXXXN	XXX° XXXX.XXXX E
6	WPT00006	XX° XXXX.XXXXN	XXX° XXXX.XXXX E
7	WPT00007	XX° XXXX.XXXXN	XXX° XXXX.XXXX E
8	WPT00008	XX° XXXX.XXXXN	XXX° XXXX.XXXX E
9	WPT00009	XX° XXXX.XXXXN	XXX° XXXX.XXXX E
10	WPT00010	XX° XXXX.XXXXN	XXX° XXXX.XXXX E

- 5 Press the [▶] key.
- 6 Select the [Yes] in the confirmation menu. (Press the [▲] key or [▼] key)

WPT delete
Yes
No

- 7 Press the [MENU] key. Then, the destination is deleted and the menu closes.

### Recall the stored image and preset it as a destination

Recall the stored image in the past and it can be preset as a destination. (See [1.9 Use of [EVENT] key])

- 1 Press the [MENU] key.
- 2 Select [Image] → [Image recall]. (See [2.1 How to operate the menu].)
- 3 Press the [▶] key.
- 4 Select the image No. from the [Image

recall] list. (Press the [▲] key or [▼] key)

Image recall	
No.	Comment
1	PIC00001
2	PIC00002
3	PIC00003
4	PIC00004
5	PIC00005
6	PIC00006
7	PIC00007
8	PIC00008
9	PIC00009
10	PIC00010

**Caution:** Chosen list NO. becomes yellow.

- 5 Press the [▶]key.
- 6 Move the cursor to the location preset as a destination with the[◀] key or [▶] key and select it.

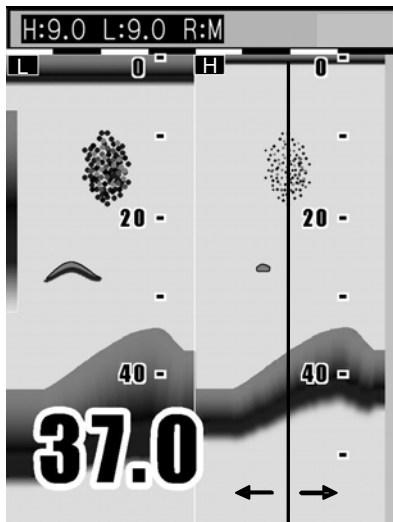

Cursor (red line)

**Caution:** You can switch to other stored image with the [▲] or [▼] key.

- 7 When starting the NAV, press the [EVENT] key. When not starting the NAV, press the [MENU] key.

## 2.15 Store / Recall / Deletion of Image

### Store the image

The present image of echo sounder can be stored.

To memorize, it takes some time.

To memorize the image, the [EVENT] key must be switched to the [Store image].

- 1 Press the [MENU] key.
- 2 Select [System] → [EVENT key set]. (See [2.1 How to operate the menu])
- 3 Press the [▶] key.
- 4 Select the [Store image]. (Press the [▲] key or [▼] key)

EVENT key set
Store pos
Store image
Fishing hot spot

- 5 Press the [MENU] key to close the menu.
- 6 When the echo sounder image to be stored appears, press the [EVENT] key.
- 7 When the stored image is fully filled, it shows that the [Store image] is fully filled. After deleting the unnecessary image, try it again.

### Recall the stored image

The stored image in the past can be recalled.

During recalling, the image cannot be stored.

- 1 Press the [MENU] key.
- 2 Select [Image] → [Image recall]. (See [2.1 How to operate the menu])
- 3 Press the [▶] key.
- 4 Select the number of image to be recalled from the [Image recall] list. (Press the [▲] key or [▼] key)

Image recall	
No.	Comment
1	PIC00001
2	PIC00002
3	PIC00003
4	PIC00004
5	PIC00005
6	PIC00006
7	PIC00007
8	PIC00008
9	PIC00009
10	PIC00010

**Caution:** Chosen list NO. becomes yellow.

5 Press the [▶] key.

**Caution:** When other stored image exists beside the recall image, switch to other image with the [▲] and [▼] key.

6 Press the [MENU] key to return to the normal menu.

### Delete the stored image

The stored image in the past can be deleted.

To delete, it takes some time.

- 1 Press the [MENU] key.
- 2 Select [Image] → [Image delete]. (See [2.1 How to operate the menu])
- 3 Press the [▶] key.
- 4 Select the number of image to be deleted from the [Image delete] list. (Press the [▲] key or [▼] key)

Image delete	
No.	Comment
1	PIC00001
2	PIC00002
3	PIC00003
4	PIC00004
5	PIC00005
6	PIC00006
7	PIC00007
8	PIC00008
9	PIC00009
10	PIC00010

5 Press the [▶] key.

6 Select the [Yes] in the confirmation menu.

Image delete	
Yes	
No	

7 Press the [MENU] key.  
Then, the preset image is deleted.

### Add the comment to the stored image

It is convenient to judge the stored image.

- 1 Press the [MENU] key.
- 2 Select [Image] → [Image comment]. (See [2.1 How to operate the menu])
- 3 Press the [▶] key.
- 4 Select the number of image to which the comment is added from the [Image comment]. (Press the [▲] key or [▼] key)

Image comment	
No.	Comment
1	PIC00001
2	PIC00002
3	PIC00003
4	PIC00004
5	PIC00005
6	PIC00006
7	PIC00007
8	PIC00008
9	PIC00009
10	PIC00010

5 Press the [▶] key.

6 Select the character with the [▲] key or [▼] key. (Character: A ~ Z, blank, 0 ~ 9, +, -/)

Image comment	
No.	Comment
1	PIC00001
2	PIC00002
3	PIC00003

7 Select the comment position with the [◀] key or [▶] key.

Image comment	
No.	Comment
1	PIC00001
2	PIC00002
3	PIC00003

- 8 To stop editing, press [GAIN (HF) Knob] or [GAIN (LF) Knob].
- 9 After finishing the edit, press the [MENU] key.
- 10 Select the [register] in the confirmation menu.

Edit end
Registered
Not registered

- 11 Press the [MENU] key. Then, the edit is finished.

## 2.16 Explanation of Sonar

### Switch-over of Sona-Tone™

The Sona-Tone™ can be output to the built-in speaker by selection.

The schools of fish and condition of bottom on the display of echo sounder can be confirmed by hearing the sonar.

- 1 Press the [MENU] key.
- 2 Select the [System] → [Sona-tone]. (See [2.1 How to operate the menu])
- 3 Press the [▶] key.
- 4 Select the [ON] or [OFF] of [Sona-tone]. (Press the [▲] key or [▼] key)

Sona-tone
OFF
ON

- 5 Press the [MENU] key to close the menu.

### Connection of External Speaker

Connect the external speaker with amplifier (option) so that you can hear the sonar easily.

**Caution:** The Sona-Tone™ is always output. Adjust the speaker volume with the volume provided on the speaker.

**Caution:** The external speaker is an option.

## 2.17 Explanation of Menu Item

The various items in the menu are explained.

### Inner-hull

The reduction in sensitivity due to signal attenuation in inner-hull use can be corrected. (Setting: - 50 ~ 50: through-hull: 0)

- 1 Press the [MENU] key.
- 2 Select the [Adjust] → [Gain (TD)]. (See [2.1 How to operate the menu])
- 3 Press the [▶] key. The image displays bottom only. It may show very strong fish targets.
- 4 Set a value to display the sea bottom continuously without interruption. For high frequency, turn [GAIN (HF) knob] and for low frequency, turn [GAIN (LF) knob].

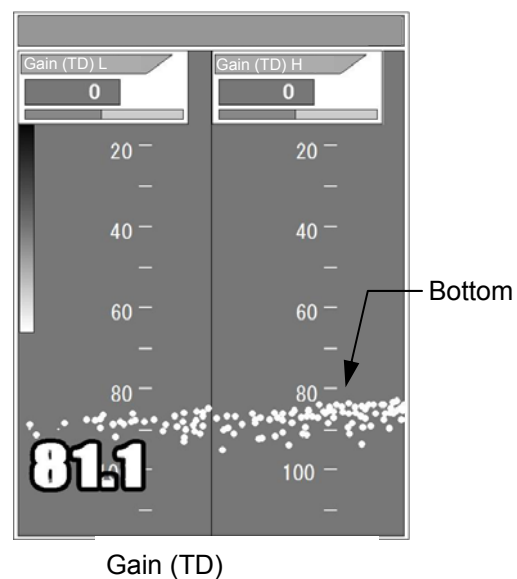

- 5 Press the [MENU] key to close the menu.



**! Caution: Gain (TD) setting value widely varies upon installation conditions such as material of hull and installation method. Low frequency (50 kHz) may not be used due to large signal attenuation in some cases.**

## TVG

The TVG adjusts the difference of strength between echoes reflected from the shallower depth and echoes reflected from deeper depth so that the reflection can be uniformed.

The deeper the depth is, the weaker the reflected signal of echo sounder becomes due to attenuation. Thus, comparing the signal reflected from the fish of the same size, the signal reflected from the fish in the shallower depth is stronger than that in the deeper depth. The TVG adjusts the echo signal reflected from the shallower depth to be equal to that reflected from deeper depth by decreasing the receiver gain so that the effect that the strength of echo signal reflected from the shallower depth looks the same as that reflected from the deeper depth provided. The level of adjustment due to the depth increases in the order of weak → medium → strong. When set to "Strong", the TVG provides strongest effect that reduces various noises around oscillation line.

- 1 Press the [MENU] key.
- 2 Select the [Adjust] → [TVG]. (See [2.1 How to operate the menu])
- 3 Press the [▶] key.
- 4 Select the [weak], [medium], [strong]. (Press the [▲] key or [▼] key)

TVG
Weak
Medium
Strong

- 5 Press the [MENU] key to close the menu.

**! Caution: When the setting of [Gain select] is either one of [Cruising] or [Fishing], it cannot be selected.**

## Change the TX power

The strength of transmission output (power) can be changed.

When the noise of interference with the neighboring echo sounder occurs, if the powers of transmission outputs at both sides are weakened, the interference noise can be suppressed.

- 1 Press the [MENU] key.
- 2 Select the [Adjust] → [TX power]. (See [2.1 How to operate the menu])
- 3 Press the [▶] key.
- 4 Select the [TX power]. (Press the [▲] key or [▼] key.)

TX power
20
30
40
50
60
70
80
90
100
Auto

- 5 Press the [MENU] key to close the menu.

**! Caution: In [Auto] setting, it controls transmission power automatically.**

## Change the Pulse width

Resolution and the detection distance change by changing the transmission pulse width. As for [Super short], the detection distance shortens though resolution goes up. As for [Long], the detection distance becomes long though resolution falls.

- 1 Press the [MENU] key.
- 2 Select the [Adjust] → [Pulse width]. (See [2.1 How to operate the menu])
- 3 Press the [▶] key.
- 4 Change the setting of [Pulse width]. (Press the [▲] key or [▼] key.)
- 5 Press the [MENU] key to close the menu.





**Caution: When the fish symbol function is made effective, this function becomes invalid.**

For CVS-128B

### Change the Bandwidth

The bandwidth is automatically set according to the transmission pulse width. Please make it to [Narrow] when you decrease the noise. Please make it to [Super narrow] when you decrease more.

- 1 Press the [MENU] key.
- 2 Select the [Adjust] → [Bandwidth]. (See [2.1 How to operate the menu])
- 3 Press the [▶] key.
- 4 Change the setting of [Bandwidth]. (Press the [▲] key or [▼] key.)
- 5 Press the [MENU] key to close the menu.



**Caution: When the fish symbol function is made effective, this function becomes invalid.**

For CVS-128B

### D.Range

D.Range is to expand and narrow down the signal range from blue to red in images.

When the value is small, the expression range of strong and weak signal change is narrow, weaker signal will become undistinguished. When the value is larger, the expression range is wider and the weaker signals become distinct. (Setting: 12 to 30dB)

- 1 Press the [MENU] key.
- 2 Select the [Adjust] → [D.Range]. (See [2.1 How to operate the menu])
- 3 Press the [▶] key.
- 4 Change the setting of [D.Range]. (Press the [▲] key or [▼] key.)
- 5 Press the [MENU] key to close the menu.

For CVS-128B

### Display Width

When the image is zoomed or dual frequency displayed, the display width can be changed.

- 1 Press the [MENU] key.
- 2 Select the [D.range] → [Disp. width]. (See [2.1 How to operate the menu])
- 3 Press the [▶] key.
- 4 Select the width of image. (Press the [▲] key or [▼] key)
- 5 Press the [MENU] key to close the menu.

### Display the A scope/Stop the display of A scope

The echo strength of latest echo can be displayed at the right side of echo sounder display.

The strength of echo sounder image is expressed by the horizontal width. This expression is called [A scope].

The width for strong echo is wide and the width for weak echo is narrow. This makes it easier for you to see the echo.

- 1 Press the [MENU] key.
- 2 Select the [Display1] → [A scope]. (See [2.1 How to operate the menu])
- 3 Press the [▶] key.
- 4 To display the A scope, select the [ON]. To stop the display of A scope, select the [OFF]. (Press the [▲] key or [▼] key)
- 5 Press the [MENU] key to close the menu.

### Change the display color of echo sounder image

The [Monochrome], [8 color], [16 color] and [64 color] can be selected.

- 1 Press the [MENU] key.
- 2 Select the [Display1] → [Color tone]. (See [2.1 How to operate the menu])
- 3 Press the [▶] key.
- 4 Select the [Color tone]. (Press the [▲] key or [▼] key)
- 5 Press the [MENU] key to close the menu.

### Change the depth value

The display size of depth value can be changed.

- 1 Press the [MENU] key.
- 2 Select the [Display1] → [Depth value]. (See [2.1 How to operate the menu])
- 3 Press the [▶] key.
- 4 Select the size of display. (Press the [▲] key or [▼] key)
- 5 Press the [MENU] key to close the menu.

### Display the depth unit / Stop the display of depth unit

The depth unit can be displayed.

- 1 Press the [MENU] key.
- 2 Select the [Display1] → [Unit display]. (See [2.1 How to operate the menu])
- 3 Press the [▶] key.
- 4 To display the depth unit, select the [ON]. To stop the display of depth unit, select the [OFF]. (Press the [▲] key or [▼] key)
- 5 Press the [MENU] key to close the menu.

### Display the water temp graph/Stop the display of water temp graph

The latest water temp value and the graph of past water temp data can be displayed.

- 1 Press the [MENU] key.
- 2 Select the [Display1] → [Water temp graph]. (See [2.1 How to operate the menu])
- 3 Press the [▶] key.
- 4 To display the water temp graph, select the [ON]. To stop the display of water temp graph, select the [OFF]. (Press the [▲] key or [▼] key)
- 5 Press the [MENU] key to close the menu.

### Setting of the background color of NAV display

The color of background of navigation display (NAV1, NAV2) can be changed.

- 1 Press the [MENU] key.
- 2 Select the [NAV] → [Background color]. (See [2.1 How to operate the menu].)
- 3 Press the [▶] key.
- 4 Select the [Background color]. (Press the [▲] key or [▼] key)
- 5 Press the [MENU] key to close the menu.

### Setting of the echo sounder display at NAV display

The sounder display can be selected at NAV (NAV 1, NAV 2) to be displayed.

- 1 Press the [MENU] key.
- 2 Select the [NAV] → [NAV1 (2)]. (See [2.1 How to operate the menu])
- 3 Press the [▶] key.
- 4 Select the echo sounder display at [NAV 1] or [NAV 2] to be displayed. (Press the [▲] key or [▼] key)
- 5 Press the [MENU] key to close the menu.

### Image Swap

The images of echo sounder at the right and left sides can be swapped.

- 1 Press the [MENU] key.
- 2 Select the [Image] → [Image swap]. (See [2.1 How to operate the menu])
- 3 Press the [▶] key.
- 4 Select the swap state [A|B],[B|A]. (Press the [▲] key or [▼] key)
- 5 Press the [MENU] key to close the menu.

### Display the Operation guide/Stop the display of Operation guide

When displaying the menu, it sets whether or not the operation guide is displayed at the lower part on the display.

When setting to “No display of operation guide”, the echo sounder image can be easily seen at the menu operation.

- 1 Press the [MENU] key.
- 2 Select the [System] → [Operation guide]. (See [2.1 How to operate the menu])
- 3 Press the [▶] key.
- 4 To display the Operation guide, select [ON]. To stop the display of Operation guide, select [OFF]. (Press the [▲] key or [▼] key)
- 5 Press the [MENU] key to close the menu.

### Display the detection area/Stop the display of detection area

The range of the search that can be detected in the angle of beam spread of the transducer used can be displayed.

- 1 Press the [MENU] key.
- 2 Select the [Display2] → [Detection area]. (See [2.1 How to operate the menu])
- 3 Press the [▶] key.
- 4 To display the Detection area, select [ON]. To stop the display of Detection area, select [OFF]. (Press the [▲] key or [▼] key)
- 5 Press the [MENU] key to close the menu.

 **Caution: The beam angle of transducer is different depending on the transducer. (See [3.3 Setting of Correct Item, Directirity angle (Low/High)].)**

### Setting of Scale display

The set of the scale display

- 1 Press the [MENU] key.
- 2 Select the [Display2] → [Scale display]. (See [2.1 How to operate the menu])
- 3 Press the [▶] key.
- 4 Select the [Scale display]. (Press the [▲] key or [▼] key)
- 5 Press the [MENU] key to close the menu.

### Change the scale value

The display size of the scale value can be changed.

- 1 Press the [MENU] key.
- 2 Select the [Display2] → [Scale]. (See [2.1 How to operate the menu])
- 3 Press the [▶] key.
- 4 Select the [Scale]. (Press the [▲] key or [▼] key)
- 5 Press the [MENU] key to close the menu.

### Change the image direction

The direction of display image can be changed.

- 1 Press the [MENU] key.
- 2 Select the [Display2] → [Image direction]. (See [2.1 How to operate the menu])
- 3 Press the [▶] key.
- 4 Select the [Image direction]. (Press the [▲] key or [▼] key)
- 5 Press the [MENU] key to close the menu.

### Setting of Depth measurement

Select the method for depth measurement, which is shown on the display.

- 1 Press the [MENU] key.
- 2 Select the [Display2] → [Bottom detection]. (See [2.1 How to operate the menu])
- 3 Press the [▶] key.
- 4 Select the [Bottom detection]. (Press the [▲] key or [▼] key)
- 5 Press the [MENU] key to close the menu.

### Change the display color

The display color can be changed.

- 1 Press the [MENU] key.
- 2 Select the [Display2] → [Color table 1] or [Color table 2]. (See [2.1 How to operate the menu])
- 3 Press the [▶] key.
- 4 Select the [Color table]. (Press the [▲] key

or [▼] key)

- 5 Press the [▶] key.
- 6 Select the color. (Press the [▲] key or [▼] key)
- 7 Press the [MENU] key to close the menu.

### Setting of Key lock

Disable the functions of controls and keys to avoid deviation of these settings by unintentionally touching them during operation.

- 1 Press the [MENU] key.
- 2 Select the [System] → [Key lock]. (See [2.1 How to operate the menu])
- 3 Press the [▶] key.
- 4 Select the [Key lock]. (Press the [▲] key or [▼] key)
- 5 Press the [▶] key.
- 6 Select the [ON] or [OFF]. (Press the [▲] key or [▼] key)
- 7 Press the [MENU] key to close the menu.

### Change the scale type

The interval of indications of scale can be changed.

- 1 Press the [MENU] key.
- 2 Select the [Display2] → [Scale type]. (See [2.1 How to operate the menu])
- 3 Press the [▶] key.
- 4 Select the [Scale type]. (Press the [▲] key or [▼] key)
- 5 Press the [MENU] key to close the menu.

### Change the bottom color

The dark red color of sea bottom can be changed.

- 1 Press the [MENU] key.
- 2 Select the [Display2] → [Color table 2] → [Bottom color]. (See [2.1 How to operate the menu])
- 3 Press the [▶] key.
- 4 Select the [Bottom color]. (Press the [▲]

key or [▼] key)

Black ← 0, , , 176, , , 255 → Red

- 5 Press the [MENU] key to close the menu.

### Change the image partition

The image partition of echo sounder can be change to "Horizontal split" or "Vertical split".

- 1 Press the [MENU] key.
- 2 Select the [Image] → [Image partition]. (See [2.1 How to operate the menu])
- 3 Press the [▶] key.
- 4 Select the [Image partition]. (Press the [▲] key or [▼] key)
- 5 Press the [MENU] key to close the menu.

### Display the frequency / Stop the display of frequency

The frequency of the transducer currently in use can be displayed.

- 1 Press the [MENU] key.
- 2 Select the [Display2] → [Freq display]. (See [2.1 How to operate the menu])
- 3 Press the [▶] key.
- 4 To display the Freq display, select the [ON]. To stop the display of Freq display, select the [OFF]. (Press the [▲] key or [▼] key)
- 5 Press the [MENU] key to close the menu.

For CVS-128B

### Selecting a display area of fish symbol indication

The fish symbol can be displayed either on side A or on side B, or on both sides, by the following operation.

- 1 Press the [MENU] key.
- 2 Select the [Image] → [Fish image]. (See [2.1 How to operate the menu])
- 3 Press the [▶] key.
- 4 Select the [A|B], [A ], [ |B]. (Press the [▲] key or [▼] key)
- 5 Press the [MENU] key to close the menu.

## Chapter 3 How to use the menu2

### 3.1 Display of Menu

After powering on, besides the menu displayed first with the [MENU] key, there are the other menus as follows, of which setting does not need to be frequently changed.

[In out], [Correct], [Setting], [Maintain]

#### Display the menu

- 1 Press the [MENU] key.
- 2 Select the [Next].

Adjust	In out
D.range	Correct
Display1	Setting
Display2	Maintain
Alarm1	Adjust2
Alarm2	
NAV	
Image	
System	
Freq*	
Next	

\* For CVS-128B

- 3 Press [▶] key to display the system menu.

Prev	Adjust
In out	D.range
Correct	Display1
Setting	Display2
Maintain	Alarm1
	Alarm2
	NAV
	Image
	Freq*
	System

\* For CVS-128B

#### Return to the normal menu

- 1 Select the [Prev].
- 2 Press the [▶] key to display the normal menu.

### 3.2 Setting of External Input / Output

Set the setting related to the input/output.

Prev	Buzzer setting	OFF
In out	Temp source	InsideSensor
Correct	Speed source	InsideSensor
Setting	Baud rate	4800
Maintain	NMEA monitor	OFF
	NMEA output data	
	NMEA output data	
	Return	

#### Buzzer Setting

Set the buzzer sound to ON/OFF.

#### Temp Source

Switch the Sensor/NMEA.

For setting of [SENSOR], use an internal water thermometer connected to the water temperature sensor with J6 connector.

For setting of [NMEA], use the input value from outside connected with NMEA of power connector.

#### Speed Source

Switch the Sensor/NMEA.

Use the built-in speed meter for sensor.

Use the external input value for NMEA.

#### Baud Rate

Change the transmission speed of external input/output.

Match the transmission speed with that of external equipment connected. (Setting: 4800, 9600, 19200, 38400)

### NMEA Monitor

The external input data can be displayed.

To return to the original menu, press the [MENU] key.

**Caution:** When [GAIN (HF) Knob] is pressed, the displayed data will stop.

### NMEA Output Data

The output of NMEA sentence can be set to ON/OFF.

- 1 Select [In out] → [NMEA output data]. (See [2.1 How to operate the menu].)
- 2 Press the [▶] key.
- 3 Select the sentence name.
- 4 Press the [▶] key.

Prev	Prev	
In out	DBT	ON
Correct	DPT	ON
Setting	GGA	OFF
Maintain	MTW	OFF
	TLL	ON
	VHW	OFF
	VTG	OFF
	ZDA	OFF
	Return	

- 5 Select the ON/OFF.

DBT
OFF
ON

- 6 Press the [◀] key to turn to the display to select the sentence name.
- 7 Further pressing of [◀] key turns to the display to select the NMEA output.
- 8 Press the [MENU] key to close the menu.

### 3.3 Setting of Correction Item

Prev	Draft set	0.0m
In out	Sonic speed	Seawater
Correct	Water temp	0.0°C
Setting	Boat speed	0%
Maintain	Beam width H	17°
	Beam width L	50°
	Size adjust	6
	Detect adjust f	4
	Bubble	OFF
	Bubble time set	5 minutes
	Return	

#### Draft Set

The tolerance of depth can be corrected.

Set the depth from the sea level to the set depth of your transducer. Normally set draft value of your boat. (Setting: expect ft: - 10.0 to 10.0, ft: -30.0 to 30.0)

#### Sonic Speed

Set the [Seawater] or [Freshwater].  
Change to meet the usage.

#### Water Temp

The error of water temp value can be corrected.  
(Setting: - 10.0 to 10.0 °C, - 10.0 to 10.0 °F)

#### Boat Speed

The tolerance of boat speed value can be corrected.

When the [Speed source] is set to [Sensor], it is corrected by %. (Setting: - 50 to 50 %)

When the [Speed source] is set to [NMEA], it is corrected by numeral. (Setting: - 10.0 to 10.0)

#### Directivity angle (Low/High)

Directivity angle of transducer which you use should be input for high and low frequency respectively.

### Bubble

Bubble-prevention process can be activated by setting [Weak] or [Strong].

### Bubble time set

While auto-range or auto-shift is in use, and if the missing image is caused by bubble, range and shift continues changes until sea bottom is detected by auto mode.

Setting the bubble time duration holds the range or shift at the level when bubble started.

If bubble disappears and sea bottom is detected, range or shift returns to auto mode.

This makes the time shorter until the image comes back to normal. After the specified time, the mode returns to the previous auto-range or auto-shift. (Setting: OFF, 1minutes to 10minutes)

## 3.4 Setting of Basic Set Item

Prev	Language	English
In out	Range&Speed unit	NM, kn
Correct	Depth unit	m
Setting	Temperature unit	°C
Maintain	Localtime offset	0.0
	GPS select	Others
	GPS initialize	No
	Return	

### Language

Switch to the language to be displayed.

 **Caution: [Language] is displayed in red characters.**

### Range & Speed Unit

It switches the display unit to [NM, kn] or [km, km/h].

### Depth Unit

It switches the unit of depth to m, fm, l.fm and ft.

### Temperature Unit

It switches the unit of temperature to °C, °F.

### Local time Offset

The local time offset can be set by 0.5 hours (30 minutes) unit. (Setting: - 11.0 to 14.0 h) (UTC: 0.0)

### GPS select

It selects whether the GPS sensor is the KODEN made one or not.

 **Caution: Only when connecting the Kodan GPS sensor to the equipment directly, select [KODEN GPS]. When connecting the GPS sensor even Kodan one) via Plotter etc to the equipment, select [Other].**

### GPS initialize

It is valid only when KODEN GPS is connected.

The GPS sensor is initialized.

 **Caution: When connecting the GPS sensor other than KODEN GPS, do not use this item.**

## 3.5 Maintenance Menu

Prev	Simulation	OFF
In out	Slideshow	OFF
Correct	Initialize	No
Setting	System check	
Maintain	All WPTs:DLT	
	All IMG DT:DLT	
	Bottom start	1.5
	Past image*	ON
	Inner-hull	No
	TD select*	TDM-091D
	Return	

\* For CVS-128B

### Simulation

When the [Simulation] is set ON, the pseudo image of echo sounder is displayed.

**Slide show**

The slide show of the images stored in [Image] → [Image recall] is available. The time intervals for image changeover can be selected from 15 seconds and 30 seconds.

**⚠ Caution: To perform slide show, registration in the list of image memory is required. When it is not registered, slide show cannot be selected.**

**Initialize**

It returns all the settings in the menu to the factory settings. However, the memorized data of display remains unchanged.

**⚠ Caution: It returns to the factory settings and the power is automatically shut down.**

**System Check**

It is used for diagnostic test.

(See [4.5 Diagnostic Test])

**All WPTs deletes**

All WPT lists can be deleted.

**All stored image deletes**

All stored image lists can be deleted.

**Bottom start**

Set up the starting depth of the seabed detection. Once set, the fish echo or the seabed shallower than set up depth will not be detected.

**Past image**

When the [Past image] is set to ON, the gain control is effective for all screens including the past image.

When the [Past image] is set to OFF, the gain control is effective for current image only.

For CVS-128B

**Inner-hull**

When the installation of a transducer is [Inner-hull], select the [Yes].

**⚠ Caution: When a setting is altered, the value of Gain (TD) will be initialized.**

**TD select**

Choose the installed transducer (TD) in the menu list.

**⚠ Caution: When transducer is chosen by model name, [Beam angle] value (directivity angle) is changed automatically depending on the transducer.**

For CVS-128B

**3.6 Setting of Adjust2 Item**

Prev	STC strength H	0.0
In out	STC depth H	50
Correct	STC strength L	0.0
Setting	STC depth L	50
Maintain	Color adjust	
Adjust2	Image speed adj	0
	Bottom limit	1.0
	Return	

The visibility of the fish school echo can be adjusted by STC setting.

Adjustment can be done for high-frequency and low-frequency independently.

**STC strength adjust Low / High**

Set smaller values for higher sensitivity.

**STC depth adjust Low / High**

Depth limitation of STC adjustment.

Unit: Meter

STC can be operated from 0 to the setting depth.



### Color adjust

Rainbow pattern of the echo image can be changed.

Set the value of each color in the range from 0 to 99%. Confirm color distribution by the rainbow pattern of the left side of the screen.

Prev	Prev	
In out	Red	95
Correct	Orange	90
Setting	Yellow	60
Maintain	Green	30
Adjust2	Sea green	20
	Light blue	15
	Marine blue	5
	Return	

**EXAMPLE:**

When the yellow value is change from 60 to 80 in the setting, the Rainbow pattern becomes as shown below.

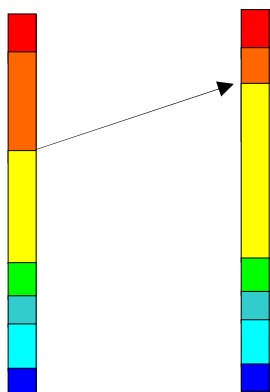

Before the change      After the change

### Image speed adjust

The image speed can be adjusted.

The image speed becomes faster in a minus direction, and slower in a plus direction.

**Caution:** Image speed cannot set faster than the maximam speed value.

### Bottom limit

The detection of sea bottom can be changed.

Sea bottom can be detected up to the range of display multiplied by the setting value.

**EXAMPLE:**

Displayed 20 m, setting value: 2.0, a bottom can be detected up to approximetry 40m.

**Caution:** If the setting value is increased, the image speed becomes slower.

### Sounding

Sounding is performed up to the maximum depth set during auto range is in operation.

The maximum range is 800 m. At the initial setup, the range is up to 200 m for CVS-128 and up to 500 m for CVS-128B. (Setting: m: 10 to 800, l.fm: 10 to 600, fm: 10 to 400, ft: 10 to 2800)

## 3.7 Frequency Select

Adjust	Freq select (L)*	42.0
D.range	Freq select (H)*	210.0
Display1	Power freq adj*	107.0
Display2	Return	
Alarm1		
Alarm2		
NAV		
Image		
System		
Freq*		
Next		

\* For CVS-128B

### Frequency select (Low / High)

The frequency of the connected transducer (low frequency and high frequency) is chosen.

**Caution:** Do not choose a frequency different from the frequency of the connected transducer.

**Caution:** When the frequency out of the specified range is choosen, the setting value is displayed in a faded color.

For CVS-128B

### **Power frequency adjustment**

It is necessary to adjust power frequency when noise appears on the image. The value for adjustment depends on the frequency of the transducer.

 **Caution: Power frequency adjustment is for internal noise, so there is no effect for external noise.**

For CVS-128B

## Chapter 4 Maintenance and Inspection

### 4.1 Inspection

The daily maintenance and inspection extends the life of equipment. To always keep the equipment in the best condition, implement periodically the inspection shown in the table below.

Item	Content of Inspection
Connector at the rear of CVS-128/128B Display unit	Check the looseness.
Wiring of cables	Check the wiring of cables connecting the equipment and the damage of cable.
Grounding of display unit	Scrape the rust off the ground terminal and make its contact well.

### 4.2 Cleaning

#### CVS-128/128B Display unit

Contamination on the screen may cause faint images. For cleaning the screen, wipe the screen with soft and clean cloth dipped with diluted neutral detergent. Pay full attention as the screen is easily getting scratched. No thinner shall be used.



Caution

The display unit has a special coating. Do not use a solvent such as paint thinner, acetone, alcohol, and benzene, etc. Strong rubbing may cause bruising or scratching.

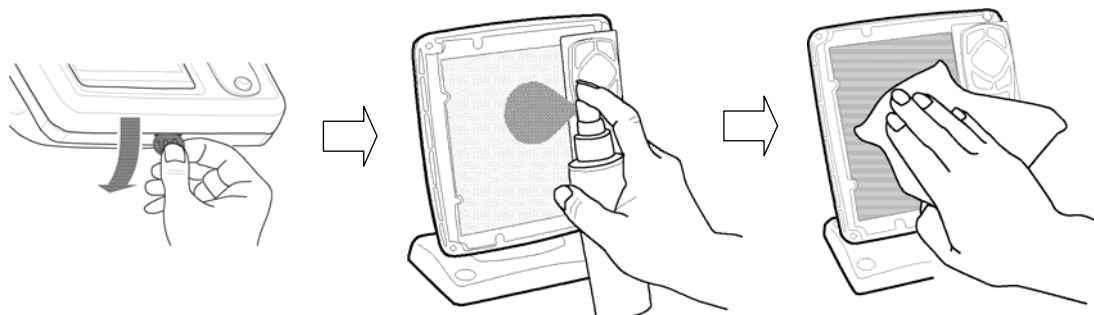

For cleaning the housing, do not use plastic solvent such as thinner or alcohol. Painting on the surface and characters at the operating portion may melt. After wiping with soft and clean cloth dipped with diluted neutral detergent, wipe away with dry soft and clean cloth.

#### Transducer

In case of through-hull equipped transducer, check the surface of opening of transducer (portion from which the ultra-sonic is emitted). If shells and oil are stuck, scrub the surface with a wooden or bamboo knife with caution not to damage the surface and remove stuck materials. If you scrub strongly, the surface will be damaged, resulting in deteriorated performance of transducer.

### 4.3 Fuse Replacement



**Warning** Use the specified fuse. If you use a fuse other than specified one, it may lead to a serious accident.

If the input voltage is too high, the over-current flows or a trouble occurs inside, the fuse will blow out. The fuse is housed in the power cable.

### 4.4 If you suspect a trouble

Symptom	Possible cause of trouble	Countermeasure
Even if the power is powered on, nothing is displayed.	<ul style="list-style-type: none"> <li>• Blown fuse.</li> <li>• The power voltage is out of specification (10.8 to 31.2 VDC).</li> <li>• Poor connection between power cable and battery.</li> </ul>	<ul style="list-style-type: none"> <li>• Exchange a fuse.(See [4.3 Fuse Replacement])</li> <li>• Use a proper power as per specification.</li> <li>• Confirm a connection between the power cable and the battery.</li> </ul>
The unit starts up. But, nothing is displayed on the display.	<ul style="list-style-type: none"> <li>• Connection between transducer and display unit.</li> <li>• Defect of LCD display block.</li> </ul>	<ul style="list-style-type: none"> <li>• Confirm a connection between Transducer and Display unit.</li> <li>• Consult a repair shop or the distributor in your market.</li> </ul>
Too much interference and noise.	<ul style="list-style-type: none"> <li>• Installed position of transducer.</li> <li>• Interference from the echo sounder on other boat.</li> </ul>	<ul style="list-style-type: none"> <li>• Confirm the position of transducer. (See [5.3 Installation of Transducer])</li> <li>• Apply the interference rejection. (See [2.3 Rejection of Interference])</li> </ul>
The display of water temperature / boat speed is abnormal or not displayed.	<ul style="list-style-type: none"> <li>• Connection of sensor connector.</li> <li>• Input source of water temperature sensor / speed sensor.</li> </ul>	<ul style="list-style-type: none"> <li>• Confirm the connection of the sensor connector.</li> <li>• Confirm the input source.</li> </ul>
The display of present location/course is abnormal or not displayed.	<ul style="list-style-type: none"> <li>• Connection between this unit and navigation equipment.</li> </ul>	<ul style="list-style-type: none"> <li>• Confirm a connection between Display unit and the navigation equipment.</li> </ul>

### 4.5 Diagnostic Test

Perform the operation diagnosis.

To check the operation diagnosis of panel key, the state of sensor inside and the version of software.

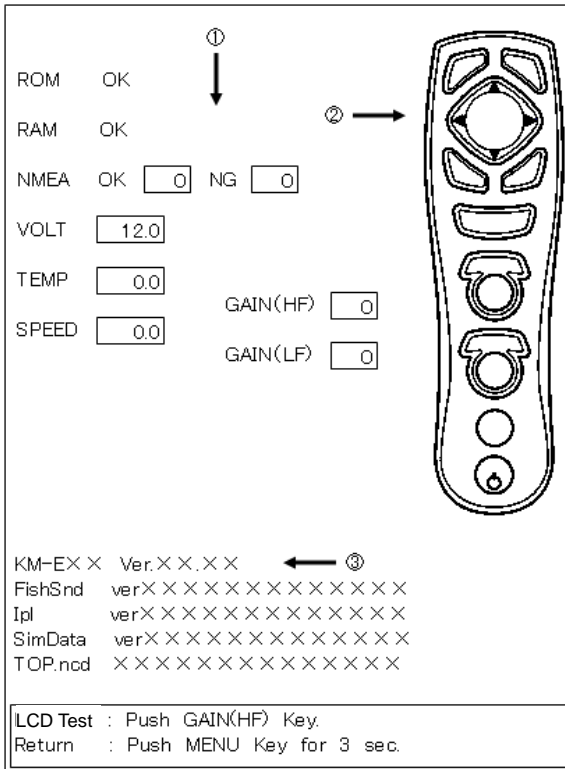

### Diagnose

① displays the diagnostic result.

The result of ROM and RAM check displays OK when normal and NG when abnormal.

**Caution:** To test the NMEA, TEMP and SPEED, the special checker is necessary.

② implements the key input test. When pressing the key, the color of a part corresponding to the pressed key changes.

When pressing the [GAIN (HF)], the LCD test is performed.

### Confirm the version

③ displays the information on the version of software.

When inquiring, inform us of Ver XX.XX.

KM-E79 Ver.xx.xx in case of CVS-128

KM-F22 Ver.xx.xx in case of CVS-128B

### Return to the menu

Press the [MENU] key for more than 3 seconds.

## Chapter 5 Installation

### 5.1 Items of Caution on Installation

To realize the full performance of echo sounder, the installation of CVS-128/128B must be performed by an engineer who is officially authorized by our company. The installation work includes the following content.

- (1) Unpacking the components
- (2) Inspection of configuration unit, spare, accessories and material for installation
- (3) Check of power voltage and capacity of current
- (4) Decision of installing location
- (5) Installation of Display unit and transducer
- (6) Installation of accessories
- (7) Plan and execution of cable laying and connection
- (8) Adjustment after completion of installation

#### Unpacking the components

Unpack the components and confirm that all of the items match with the contents on the equipment configuration list. If not matched, contact the dealer you purchased or our sales company.

#### Inspection of components and accessories

Inspect the appearance of each components and accessories and check that no dents or damage exist.

If any dents or damage exist and they are believed to be caused by accident during transportation, contact the transportation and insurance company and consult our sales company or our dealer nearest to you.

#### Decision of Installing Location

To realize the full performance of equipment, install the equipment, considering the points mentioned below.

- (1) Install the equipment at the location in the bridge so that its display can be easily seen.
- (2) Select a safe location where the equipment is not exposed to humidity, water splash, rain and direct sunshine.
- (3) Keep enough space for maintenance. Especially, secure enough space at the rear panel where many cables are concentrated.
- (4) Keep the equipment as far away from the wireless transmitter/receiver as possible.

 <b>Caution</b>	The equipment is not waterproof. Avoid excessively damp place. Do not install the equipment in the place suffering from excessive waterdrops. Otherwise, the corrosion may occur inside.
--	--

## Laying and Connection of Cable

- (1) Keep the transducer and power cable as far away from the cables of other electronic equipment as possible.
- (2) The cabinet of Display unit shall be securely grounded to the hull, using the ground terminal on the rear panel.

**⚠ Caution: The ground side of power input of this equipment is connected to the ground terminal.**

**In case of + (positive) ground, it cannot be used. The power may short-circuit.**

- (3) If you connect the power cable directly to the battery, the interference from other electronic equipment is not subject to occurrence. (See Fig. 5.1.)

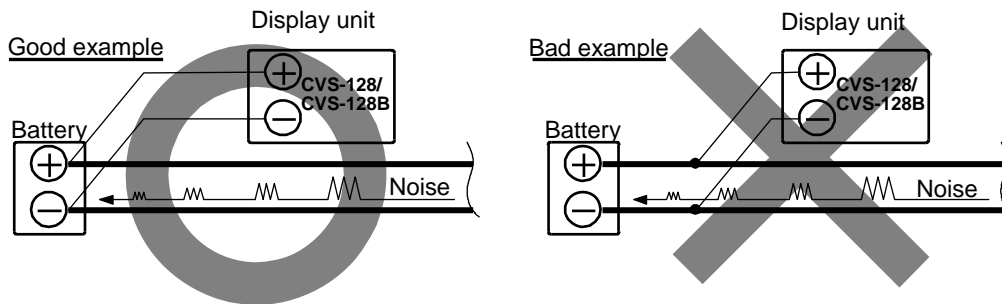

Fig. 5.1 Connection of Power Line

## Confirmation after Installation

Be sure to confirm the following items before starting up this equipment. The confirmation is mandatory to operate the equipment normally.

- (1) Is the power voltage in the boat within the appropriate voltage range? Is the current capacity enough?  
Voltage Range: 10.8 to 31.2 VDC when measured at the power connector input.
- (2) Is the electric current capacity sufficient? (Power consumption: 25 W)
- (3) Is the wiring of transducer cable correct? Is the wiring shorted?

## 5.2 Installation of CVS-128/128B Display unit

CVS-128/128B Display unit can be installed either on desk-top or flush-mounted.

Install in the following procedure.

### Desk-top Installation

- (1) Remove two knob bolts fixing the display unit to the bracket.
- (2) Remove the display unit from the bracket and place it on the stable flat place.
- (3) Place the bracket on the position where the display unit will be installed and fix the bracket with five 5 mm screws.
- (4) Place the display unit on the installation bracket and fix the display unit with two knob bolts removed in step 1.

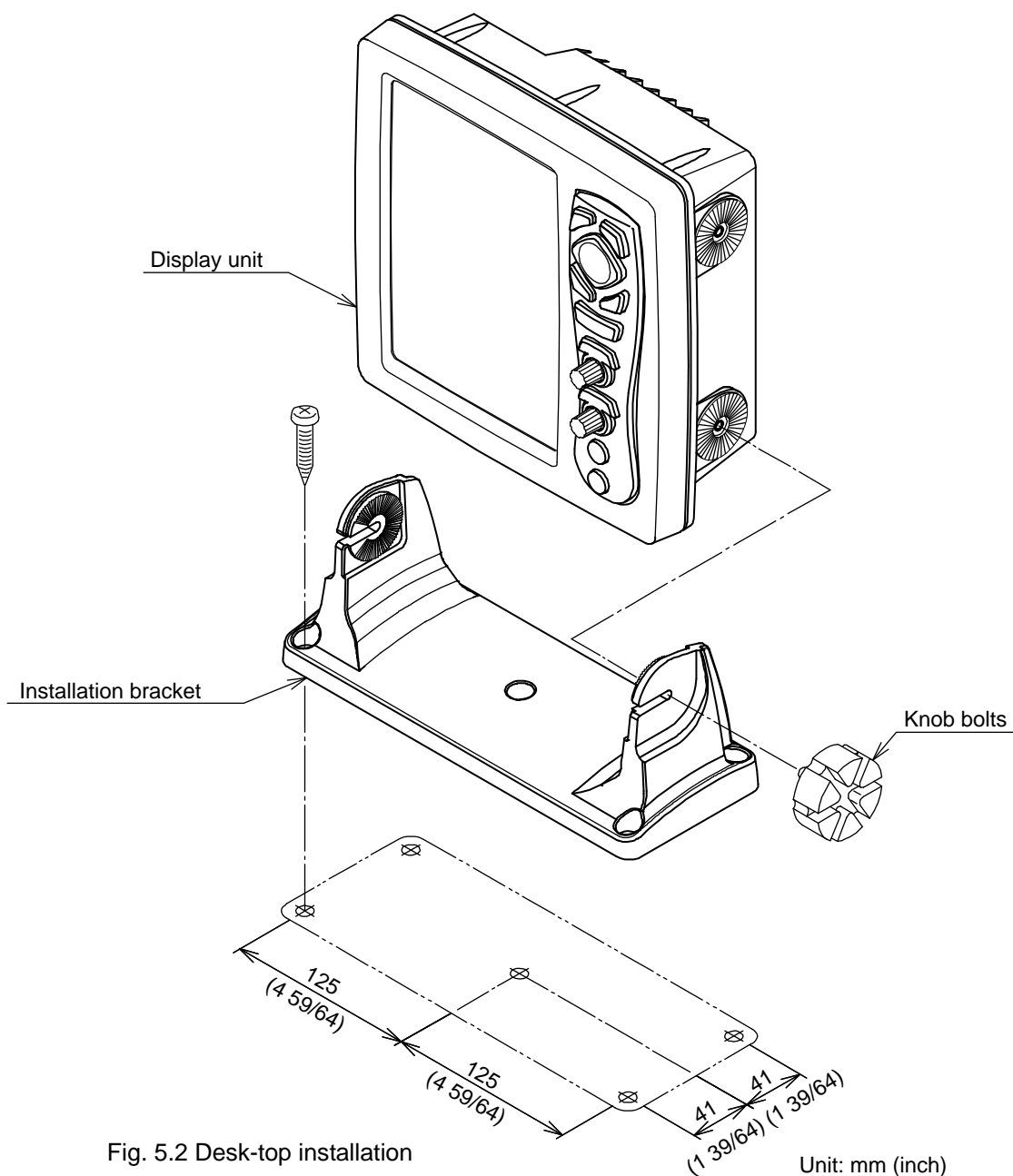

Fig. 5.2 Desk-top installation

Unit: mm (inch)



**⚠ Caution:** When installing on the desktop, the maintenance space shown in the illustration below is required for cable lay-out, plugging-in/out of connector, fuse replacement and bolt tightening.

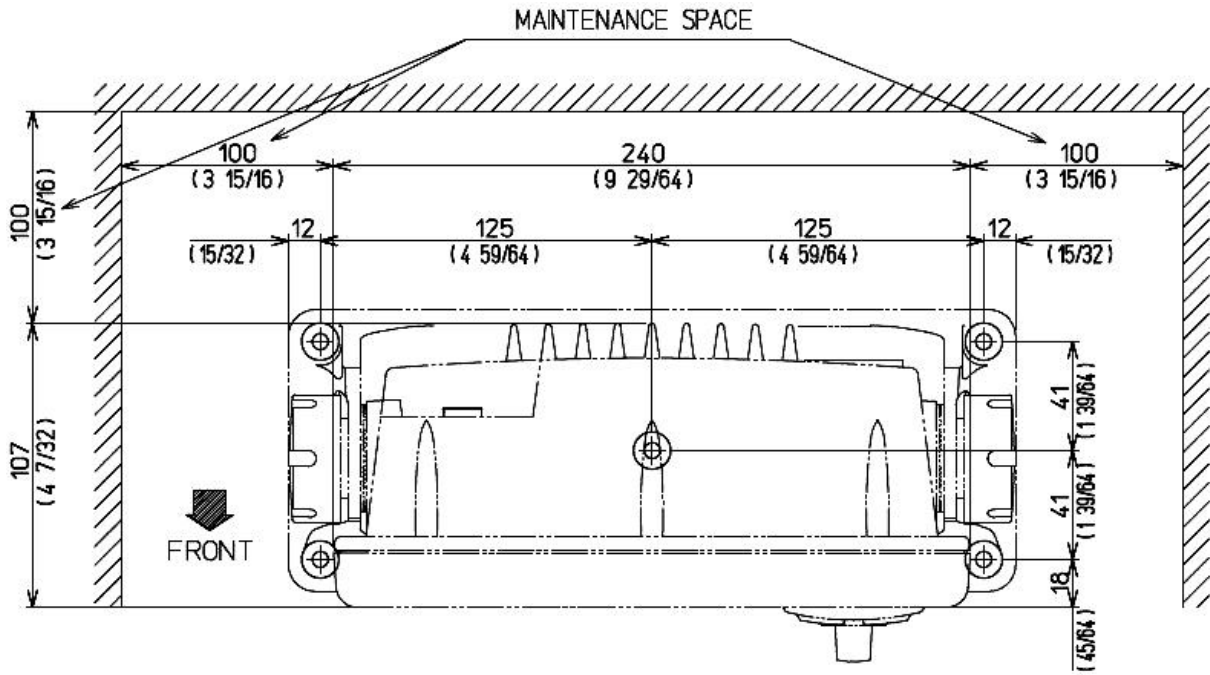

Fig. 5.3 Maintenance space

## Flush-mount Installation

- (1) Make a square hole at the location to be installed. (See Fig. 5.5.)
- (2) Turn counter-clockwise the knob bolt fixing the display unit to the mounting bracket to loosen it, push the unit to the left side and pull the unit upward. The mounting bracket and knob bolt are not used.
- (3) Confirm that the unit matches with the square holes. If not matched, correct the square hole.
- (4) Remove the front frame of the display unit, pulling it toward you. (See Fig. 5.4.)
- (5) Connect the connectors for power and transducer to the unit respectively.
- (6) Install the display unit in the installing location (square hole) and fix it with four tapping screws (4mm) (M4 or pan-head). (Prepare 4mm screws suitable for thickness of installing location.)
- (7) Install the front frame removed in step (4).

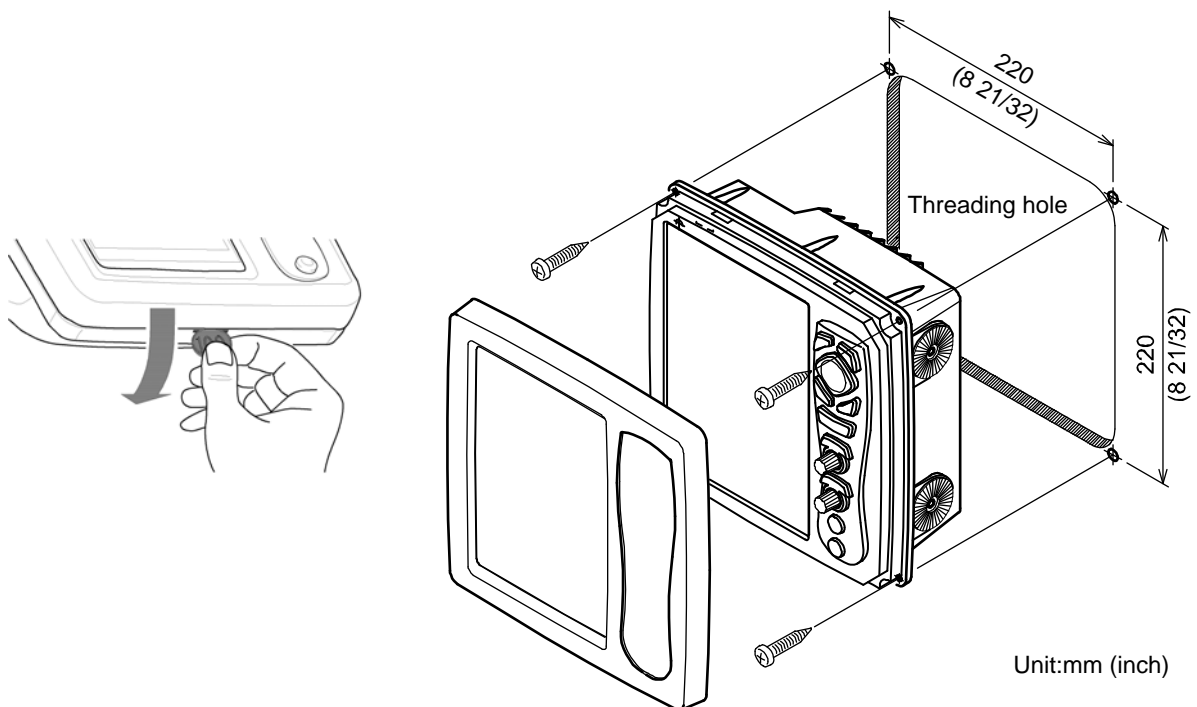

Fig. 5.4 Flush-mount Installation

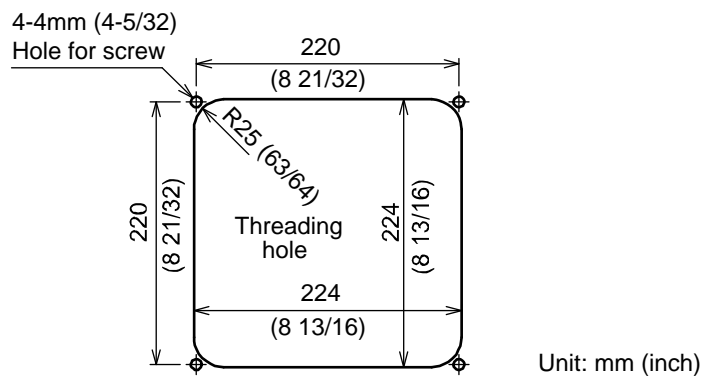

Fig. 5.5 Work of flush-mount installation hole

## 5.3 Installation of Transducer

The standard installation of the transducer is shown in figure 5.6.

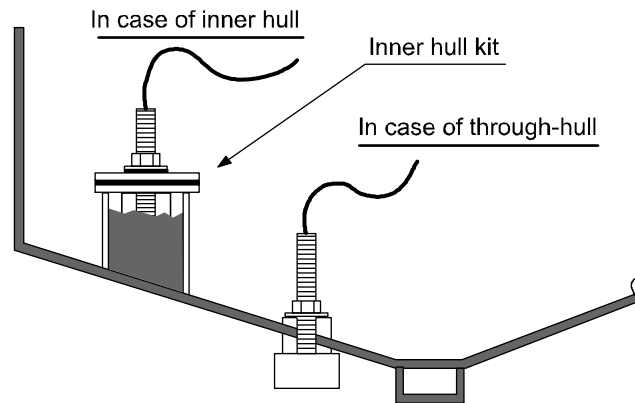

Figure 5.6 Installation of Transducer

### In case of Inner-hull

Using the optional inner-hull kit (MFB-04), install the transducer to the inner side of ship's bottom.

#### Caution on installation

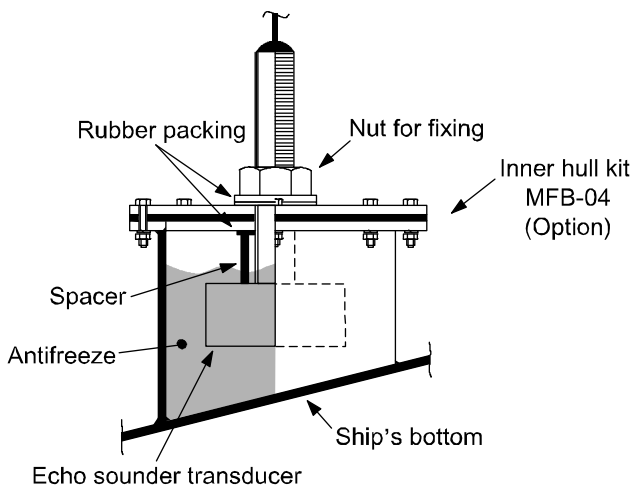

Figure 5.7 Inner-Hull installation

- (1) Select the location where no bubble is generated during navigation.
- (2) Select the relatively thin location of ship's bottom.
- (3) Be sure to remove oil on the contact surface. File the contact surface with sand paper (#400) so that the adhesive strength will increase.
- (4) The adhered surface will dry in about two hours.
- (5) Leave the unit for a whole day and fill in the coolant. More than 80 % of the transducer should be submerged in the coolant.

**⚠ Caution:** It is strongly recommended to confirm the location of the installation of Inner-hull with the ship manufacturer. The Inner-hull device is more simplified method. The gain falls dramatically in comparison with the Through-hull performance. Low frequency (50 kHz) may not be used due to large signal attenuation in some cases. Depth range performance using 200 kHz Transducer in case of Inner-hull can be less about 50% than that of Through-hull.

**⚠ Caution:** Fishing boats may have structure with FRP contained air bubbles and foamed materials that would prevent ultrasound from penetration. Therefore, the location convenient for installation may not be locations where attenuation of ultrasound is low enough.

## In case of Through hull

Install the transducer directly to the ship's bottom

### Installation Procedure

- (1) Select the installing location.
- (2) Remove the fixing nut and one piece of rubber packing.
- (3) If the slope of ship's bottom is greater than  $5^\circ$ , make a wooden base to fit to the slope of ship's bottom. To reduce the water resistance, cut the bow direction tip of wooden base at the outer side of ship's bottom in the triangle shape.
- (4) Make holes at the installing location. If the wooden base is used, make holes in the wooden base.
- (5) Thread the rubber packing in the transducer and then the cable.
- (6) To prevent water from seeping through the gap between the transducer and the hole, fill out the gap with FRP or silicon glue. (Glue the wooden base likewise.)
- (7) Thread the rubber packing and fix it with the fixing nut firmly.
- (8) Connect the transducer cable to the connector of Display unit.

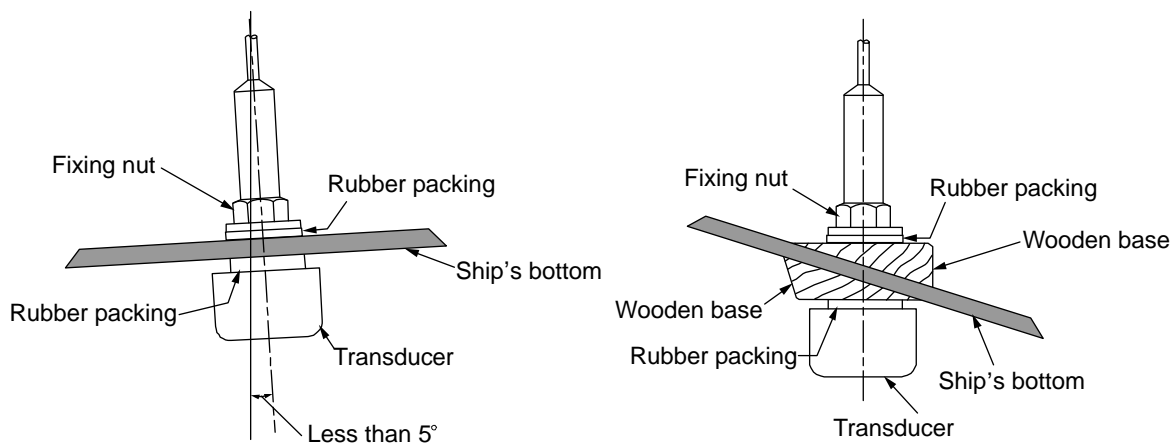

In case that the slope of ship's bottom is less than  $5^\circ$

In case that the slope of ship's bottom is greater than  $5^\circ$

Figure 5.8 Through-hull Installation

## 5.4 Wiring

### Connection of Cable to CVS-128/128B Display unit

Connect the power cable and transducer to the connectors of CVS-128/128B Display unit.

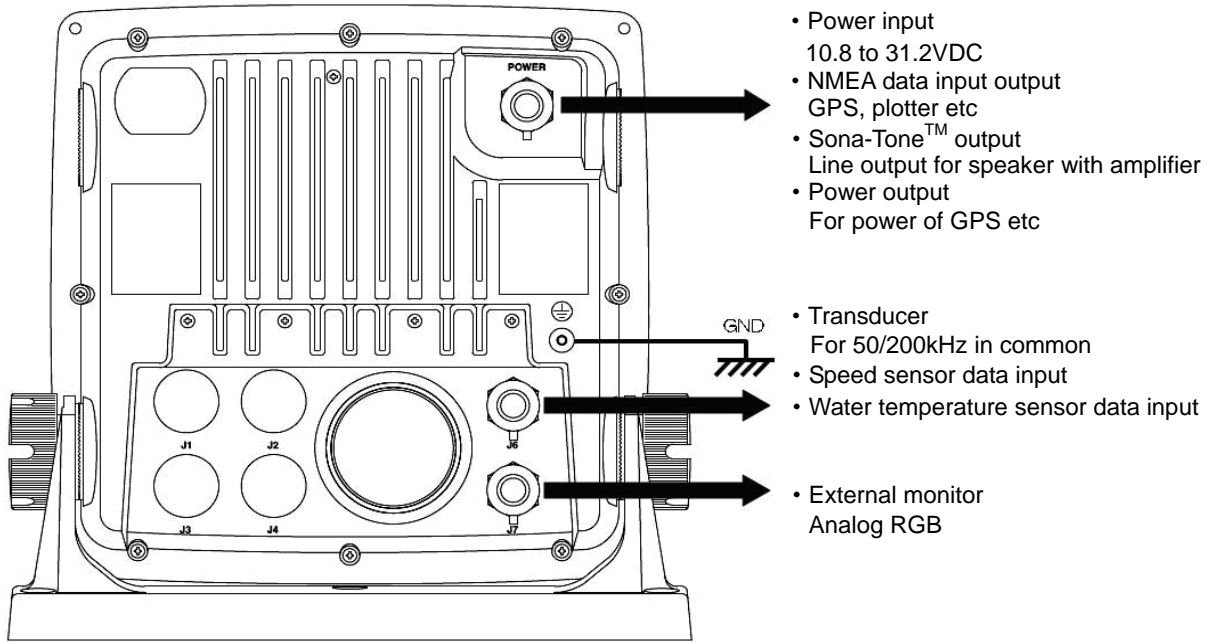

### Pin Assignment of Rear Connector

Pin assignment viewed from the rear of Display unit.

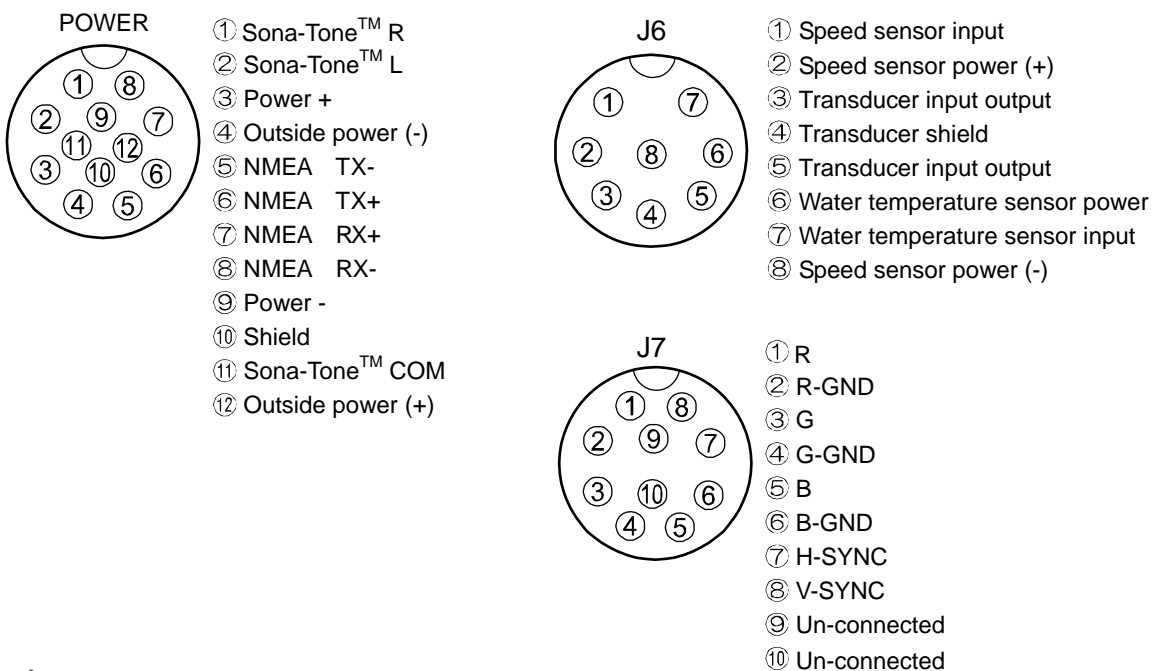

**Caution: Do not connect each wire to ship's earth.**

## Connection of Power Cable

Connect the power cable to the [POWER] connector and the transducer to the [J6] at the rear of Display unit connector.

### Connection of DC power cable (CW-264A-2M)

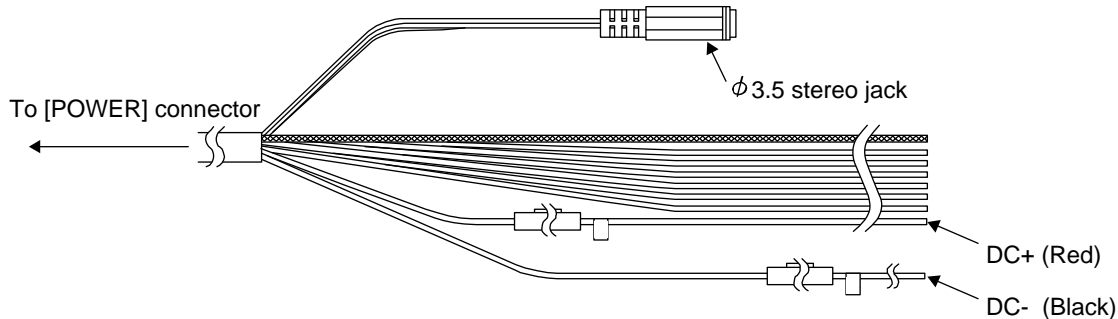

**Caution:** Wind the insulation tape around the un-used lead wire for core-wires not to contact each other.

### Grounding

- Use heavy gauge cable for grounding wire.
- Connect the grounding wire to the grounding material in a short distance.
- When connecting the external equipment of which positive polarity is connected to the ground line, do not connect the ground of signal line to the cabinet ground.

**Connection of Transducer**

At the end to the transmission/receiving cable for TD-500T-2B, TD-500T-3B, TD-501T-3B, TDM-071 and TDM-091D a water proof connector with 8-core is provided.

At the end to the transducer for TD-501C is plain.

- 1) TD-500T-2B/500T-3B/501T-3B/TDM-071/TDM-091D  
Connect to the J6 connector on the back of the receiver display unit.

- 2) TD-501C

**The user must have the cable, CW-840-0.3M for the transducer.**

Solder the transducer to CW-840-0.3M while referring to the table on connecting transducers.

After soldering is completed, please be sure to add water-resistance and insulation by applying electrical tape (or other such tape) onto the soldered part of the cable.

Transducer Connection Table

Transducer Cable		Transducer
2 lead shield wire number	2 lead shield wire color	TD-501C
③	orange	black
④	shield	shield
⑤	white	white

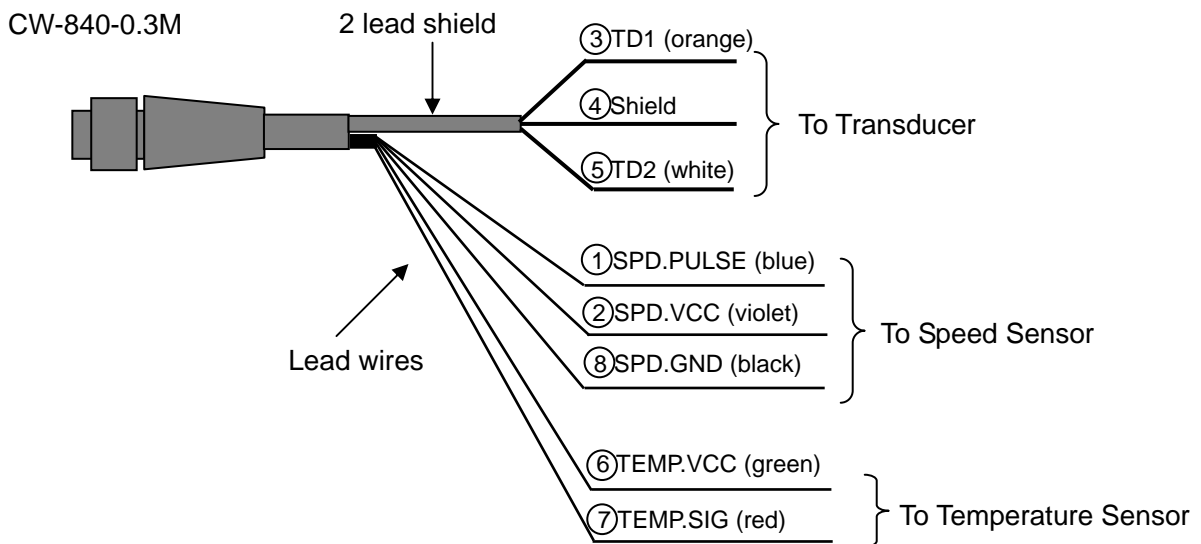

**⚠ Caution: Wind the insulation tape around the un-used lead wire for core-wires not to contact each other.**

### Connection with external equipment

The DC power cable contains the connection cables for external equipment such as navigation equipment and KODEN GPS sensor.

Color	Pin	Remark
Red	③	Power +
Black	⑨	Power -
Orange	⑥	NMEA TX +
Blue	⑤	NMEA TX -
White	⑦	NMEA RX +
Green	⑧	NMEA RX -

Color	Pin	Remark
White	②	Sona-Tone™
Red	①	External speaker output (with ø3.5 stereo jack)
Black	⑪	
Yellow	⑫	Outside power (+)
Gray	④	Outside power (-)
Shield	⑩	

### Connection with GPS-20A

After soldering, implement the waterproof and insulation treatment on the connected part with the self-melting tape.

CVS-128/128B DC power cable (CW-264A-2M)		GPS-20A (No Type) Connecting up without using a connector	GPS-20A (Type B) Connecting up using a connector*
Color	Remark	Color	Pin
Orange	NMEA TX +	Orange	②
Blue	NMEA TX -	Blue	③
White	NMEA RX +	White	④
Green	NMEA RX -	Green	⑤
Yellow	Outside power (+)	Red	⑥
Gray	Outside power (-)	Black	①

\*Optional connector (LTWBD-06PMMP-LC) is necessary.



**Connection with Speed Sensor or Water Temperature Sensor (Option)**

When installing the optional speed sensor or water temperature sensor, connect to the [J6] connector together with the transducer via the transducer cable (Type: CW-840-0.3M). For wiring, see the figure below.

After soldering, implement the waterproof and insulation treatment on the connected part with the self-melting tape.

**Structure of Transducer Cable**

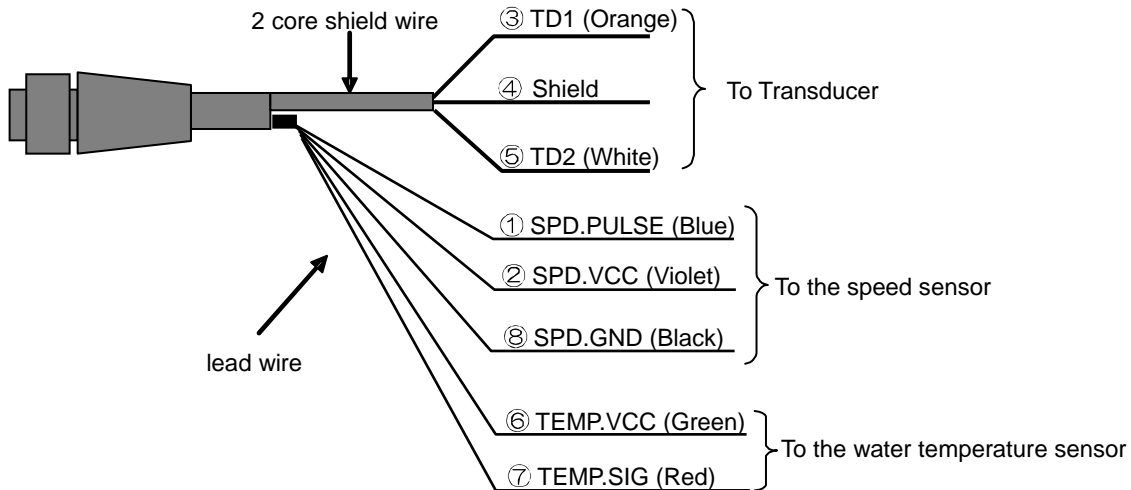

**⚠ Caution: Wind the insulation tape around the un-used lead wire for core-wires not to contact each other.**

**Connection Table of Transducer**

Transducer Cable		Transducer	
No. of 2 core shield	Color of 2 core shield	TD-500T-2B TD-500T-3B	TD-501T-3B TD-501C
③	Orange	Red	Black
④	Shield	Shield	Shield
⑤	White	White	White

**Connection Table of Speed Sensor and Water Temperature Sensor**

Transducer Cable		Water Temperature Sensor / Speed Sensor			
No. of lead wire	Color of lead wire	T-81	ST-80 ST-80-1	ST-90 ST-90-1	ST-100 ST-100-1
①	Blue	—	Green	Green	Green
②	Violet	—	Red	Red	Red
⑥	Green	Gray	White	White	White
⑦	Red	Gray	Brown	Brown	Brown
⑧	Black	—	Shield	Shield	Shield

**⚠ Caution: No.8, SPD.GND (Black), only use for speed sensor. Do not connect with other grounding wire.**

**Connection of External Speaker for Sona-Tone™ (Prepared by a customer)**

The ø3.5 stereo jack is provided to the power cable.

If you connect the speaker with the amplifier to the external, you can clearly hear the Sona-Tone™ sound.

Adjust the volume of speaker with the amplifier equipped to the speaker

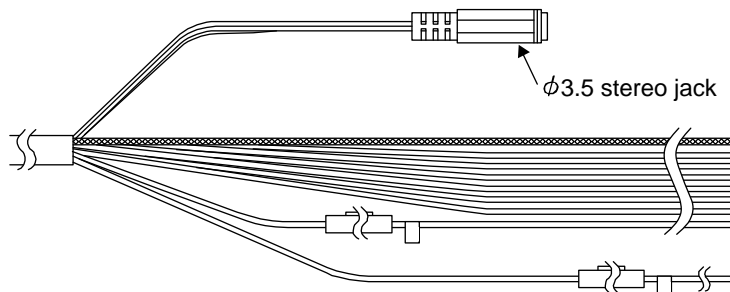

**Connection of External Monitor (J7) (Prepared by a customer)**

When installing an external monitor (VGA monitor, analog RGB input), connect it via CW-576-0.5M. For its wiring, refer to the illustration below.

**Structure of CW-576-0.5M**

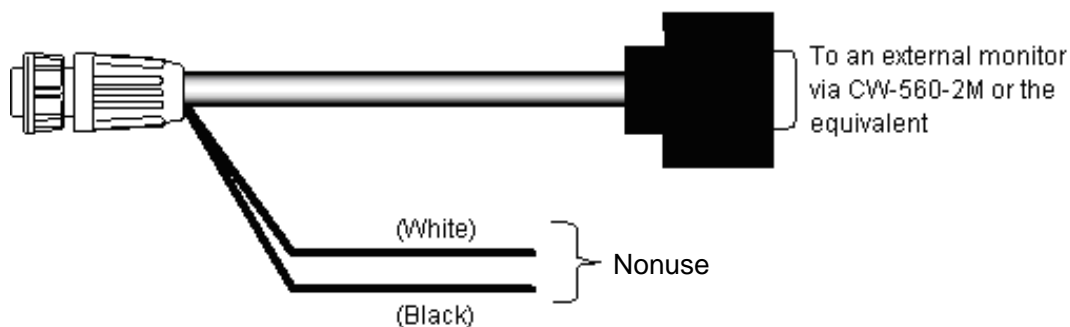

## 5.5 Serial Data

### Input Data

The sentences of GGA, GLL, HDT, MTV, MWV, RMC, VHW, VTG and ZDA can be received.

The type of NMEA0183 Ver.1.5, Ver.2.0 and Ver.3.0 can be input.

Information	Priority Order of Sentence	Information	Priority Order of Sentence
Latitude, Longitude	GGA > RMC > GLL	Wind Direction	MWV
Course	VTG > RMC	Wind Speed	MWV
Heading	HDT	Date	ZDA > RMC
Ground Speed	VTG > RMC	Time	ZDA > GGA
Water Speed	VHW	Water Temperature	MTW

### Output Data

The sentences of DBT, DPT, GGA, GLL, HDT, MTW, MWV, RMC, TLL, VHW, VTG and ZDA can be transmitted.

The output is performed in the type of NMEA0183 Ver.2.0. However, the DBT is performed in Ver.1.5.

Sentence	Information	Sentence	Information
DBT	Depth	MWV	Wind Direction, Wind Speed
DPT	Depth from the transducer	RMC	Latitude/Longitude, Course, Ground Speed, Date
GGA	Latitude/Longitude, Time	TLL	Target Position
GLL	Latitude/Longitude	VHW	Water Speed
HDT	Heading	VTG	Course, Ground Speed
MTW	Water Temperature	ZDA	Date, Time

## Chapter 6 Table Attached

### 6.1 Menu List

The factory set value is shown by the bold and underline.

[Disp] key

Disp NAV1, Normal (H), Zoom (H), **Dual freq**, Zoom (L), Normal (L), NAV2

[▲RANGE▼] key

RANGE **Auto range**, 5.0, 10.0, 20.0, 50.0, 100, 160, 300, 500, Auto shift

[GAIN(HF) ], [GAIN(LF) ]

Gain select Manual, Cruising, **Fishing**

Auto adjust - 30 to 10 (H): **0**, (L): **0**

Gain 0.0 to 10.0 (H): **6.0**, (L): **6.0**

[BRILL] key

LCD brill 1 to 10: **10**

Panel brill 1 to 10: **10**

[EVENT] key

**Store pos**, Store image, Fishing hot spot

[F1] key

**Image speed**, IR, Color rejection, Noise rejection, Shift, Zoom range, Zoom start, A scope, White line, Background color, Disp width, NAV start, NAV1, NAV2, Image swap, Image recall, Sona-tone

[F2] key

Image speed, IR, Color rejection, Noise rejection, **Shift**, Zoom range, Zoom start, A scope, White line, Background color, Disp width, NAV start, NAV1, NAV2, Image swap, Image recall, Sona-tone

[MENU] key

- Adjust
  - Image speed (Speed1, Speed2, Speed3, Speed4, Stop, **Speed5 (1/1)**, Speed6, Speed7, Speed8, Speed9)
  - IR (OFF, Weak, Strong : **Strong** (For CVS-128) , **Weak** (For CVS-128B))
  - Color rejection (0 to 50 %: **0%**)
  - Noise rejection (0 to 10: **0**)
  - TVG (Weak, **Medium**, Strong)
  - TX power (20, 30, 40, 50, 60, 70, 80, 90, 100, **Auto**)
  - Gain (TD) (-50 to 50)
 

Inner-hull : No H: <b>0</b> , L: <b>0</b>	Inner-hull : Yes H: <b>15</b> , L: <b>30</b>
--	---
  - Pulse width (Super short, Short, **Middle**, Long) (For CVS-128B)
  - Band width (Super narrow, Narrow, **Middle**) (For CVS-128B)
  - D.Range (12dB to 30dB: **24dB**) (For CVS-128B)
- D.range
  - Shift step (**1m**, 10m, 1/8, 1/4)
  - Zoom type (**Bottom**, Bottom Discrimination, Zoom, Bottom Zoom, Bottom Follow Zoom)
  - Zoom range (2.5 to 200 m: **10.0 m**)
  - Zoom start (0 to 800 m: **0m**)
  - Disp width (Left2, Left1, **Center**, Right1, Right2)
  - Range preset
 

Inner-hull : No	Inner-hull : Yes
Range 1 (2.5 to 1200 m: <b>5.0</b> )	Range 1 (2.5 to 1200 m: <b>5.0</b> )
Range 2 (2.5 to 1200 m: <b>10.0</b> )	Range 2 (2.5 to 1200 m: <b>10.0</b> )
Range 3 (2.5 to 1200 m: <b>20.0</b> )	Range 3 (2.5 to 1200 m: <b>20.0</b> )
Range 4 (2.5 to 1200 m: <b>50.0</b> )	Range 4 (2.5 to 1200 m: <b>50.0</b> )
Range 5 (2.5 to 1200 m: <b>100</b> )	Range 5 (2.5 to 1200 m: <b>80</b> )
Range 6 (2.5 to 1200 m: <b>160</b> )	Range 6 (2.5 to 1200 m: <b>100</b> )
Range 7 (2.5 to 1200 m: <b>300</b> )	Range 7 (2.5 to 1200 m: <b>160</b> )
Range 8 (2.5 to 1200 m: <b>500</b> )	Range 8 (2.5 to 1200 m: <b>200</b> )
- Display1
  - A scope (**OFF**, ON)
  - White line (**OFF**, 1, 2, 3, 4, 5, Auto)
  - Background color (Pale blue, Marine blue, Blue, **Dark blue**, Black, Darkkhaki, Mediumseagreen, Light grey, White, Night mode)
  - Color tone (Monochrome, 8 color, 16 color, **64 color**)
  - Depth value (OFF, Small, Middle, **Large**)
  - Unit display (**OFF**, ON)
  - Water temp graph (**OFF**, ON)
  - Fish symbol (**OFF**, Symbol 1 to Symbol 10)
  - Symbol info (**OFF**, Depth, Size, Bottom<=>Fish)
- Display2
  - Detection area (OFF, **ON**)
  - Scale display (OFF, One, **All**)
  - Scale (Small, Middle, **Large**)
  - Image direction (←|← , →|→ , ←|→)
  - Bottom detection (**Auto**, High frequency, Low frequency)
  - Color table1 (Header information, Header BG color, VRM, Depth, Scale, Scale line, Detection area H, Detection area L)
  - Color table2 (Symbol info, Menu BG color, Big fish color, Bottom color)
  - Scale type (**0**, 1)
  - Big fish (20 to 90: **50**)
  - Freq display (OFF, **ON**) (For CVS-128B)

A

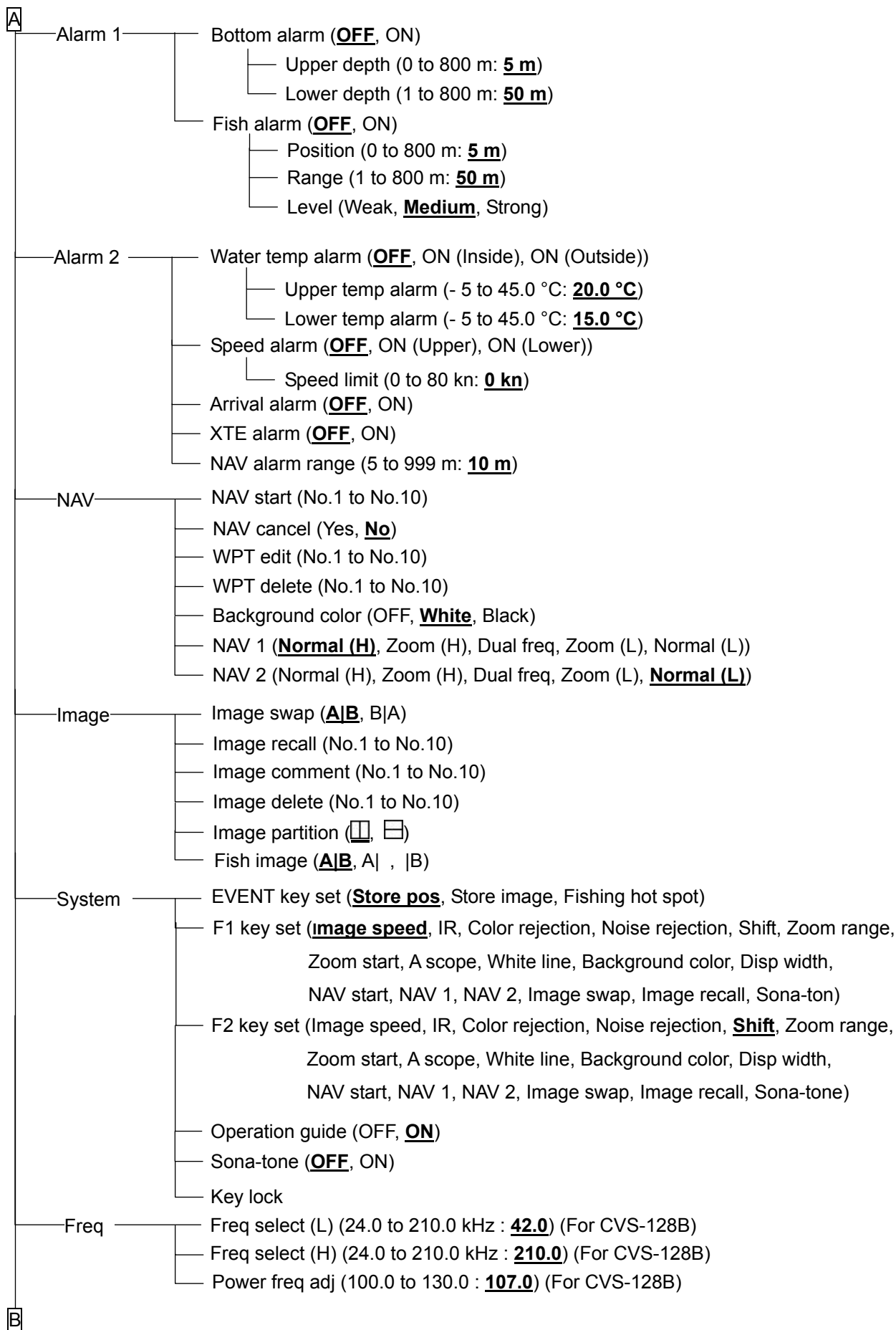

<b>B</b>	<ul style="list-style-type: none"> <li>In out                     <ul style="list-style-type: none"> <li>Buzzer setting (OFF, <b>ON</b>)</li> <li>Temp source: (<b>InsideSensor</b>, NMEA)</li> <li>Speed source (<b>InsideSensor</b>, NMEA)</li> <li>Baud rate (<b>4800</b>, 9600, 19200, 38400)</li> <li>NMEA monitor (<b>OFF</b>, ON)</li> <li>NMEA output data (ON : DBT, DPT, TLL OFF : GGA, MTW, VHW, VTG, ZDA)</li> <li>NMEA output data (ON : None OFF : GLL, HDT, MWV, RMC)</li> </ul> </li> <li>Correct                     <ul style="list-style-type: none"> <li>Draft set (- 10.0 to 10.0 m: <b>0.0 m</b>)</li> <li>Sonic speed (<b>Seawater</b>, Freshwater)</li> <li>Water temp (- 10.0 to 10.0 °C: <b>0.0 °C</b>)</li> <li>Boat speed (- 50.0 to 50.0 %: <b>0%</b>)</li> <li>Beam angle H (1 to 120: <b>17°</b>)</li> <li>Beam angle L (1 to 120: <b>50°</b>)</li> <li>Size adjust (1 to 10: <b>6</b>)</li> <li>Detect adjust f (1 to 6: <b>4</b>)</li> <li>Bubble (<b>OFF</b>, Weak, Strong)</li> <li>Bubble time set (OFF, 1 to 10minutes: <b>5minutes</b>)</li> </ul> </li> <li>Setting                     <ul style="list-style-type: none"> <li>Language (English, Japanese, etc)</li> <li>Range&amp;Speed unit (<b>NM, kn</b>, km, km/h)</li> <li>Depth unit (<b>m</b>, fm, l.fm, ft)</li> <li>Temperature unit (<b>°C</b>, °F)</li> <li>Localtime offset (- 11.0 to 14.0: <b>0.0</b>)</li> <li>GPS select (<b>Others</b>, KODEN GPS)                             <ul style="list-style-type: none"> <li>GPS initialize (<b>No</b>, Yes)</li> </ul> </li> </ul> </li> <li>Maintain                     <ul style="list-style-type: none"> <li>Simulation (<b>OFF</b>, ON)</li> <li>Slideshow (<b>OFF</b>, 15, 30)</li> <li>Initialize (<b>No</b>, Yes)</li> <li>System check</li> <li>All WPTs: DLT (<b>No</b>, Yes)</li> <li>All IMG DT: DLT (<b>No</b>, Yes)</li> <li>Bottom start (0.0 to 20.0: <b>1.5</b>)</li> <li>Past image (OFF, <b>ON</b>) (For CVS-128B)</li> <li>Inner-hull (<b>No</b>, Yes)</li> <li>TD select (TDM-071, <b>TDM-091D</b>, Others TD) (For CVS-128B)</li> </ul> </li> <li>Adjust2                     <ul style="list-style-type: none"> <li>STC strength H (-10.0 to 10.0: <b>0.0</b>)</li> <li>STC depth H (2 to 1000: <b>40</b>)</li> <li>STC strength L (-10.0 to 10.0: <b>0.0</b>)</li> <li>STC depth L (2 to 1000: <b>40</b>)</li> <li>Color adjust (Red:<b>90</b>, Orange:<b>78</b>, Yellow:<b>66</b>, Green:<b>53</b>, Sea green:<b>39</b>, Light blue:<b>25</b>, Marine blue:<b>12</b>)</li> <li>Image speed adj (-10 to 10: <b>0</b>)</li> <li>Bottom limit (1.0 to 3.0: <b>1.0</b>)</li> <li>Sounding (10 to 800m: <b>200m</b>(For CVS-128), <b>500m</b>(For CVS-128B))</li> </ul> </li> </ul>
----------	---

## 6.2 Specification

Item	Content
Model	CVS-128
Output power (RMS)	600W or 1kW
Output frequency	50 kHz and 200 kHz
Output method	Single or Alternate
TX rate	3000 times/minute at maximum (In case of single frequency, Range 2.5m and Interference rejection off)
Pulse width	50 $\mu$ s to 3.0 ms
Display size and type	8.4 inch color TFT LCD
Display resolution	640 x 480 pixels (VGA)
Basic range	2.5 to 1200 (m), 10 to 3600 (ft), 2.5 to 700 (fm / l. fm) (8 ranges can be set to users choice)
Zoom range	2.5 to 200 (m), 10 to 650 (ft), 2.5 to 150 (fm/ l. fm)
Range unit	m, ft, fm, l.fm
Shift	Max 1200 (m), 3600 (ft), 700 (fm / l. fm)
Shift step	1m, 10m, 1/8, 1/4
Presentation modes	High frequency, Low frequency, Dual frequency, Zoom image (Bottom lock, Bottom discrimination, Bottom zoom, Zoom, Bottom follow zoom), Nav mode, Vertical split, Horizontal split A-scope can be displayed at all above modes
Presentation colors	64 colors, 16 colors, 8 colors, Monochrome
Back ground colors	Marine blue, Blue, Black, White, Nighttime color, Other 5 colors
Alarms	Bottom, Fish, Temperature*, Speed**, Arrival***, XTE***
Image speed	9 steps & stop
Functions	Interference rejection, Color rejection, VRM, Noise rejection, White line, Draft correct, Water temperature correct, Boat speed correct, Store image (10 images), Sona-Tone™, Fishing Hot Spot, Event memory, Simple plotter, Panel illumination, Power reduction, Fish information, Detection area display etc
Auto functions	Range, Shift, Gain
Function registration	Image speed, A scope, Shift, Interference rejection, Color rejection, Noise rejection, Zoom range, Zoom start, White line, Background color etc
Language	Chinese, English, French, Greek, Italian, Japanese, Korean, Spanish, Thai
Input data format and sentences	NMEA0183 Ver.1.5 / 2.0 / 3.0 GGA, GLL, HDT, MTW, MWV, RMC, VHW, VTG, ZDA
Output data format and sentences	NMEA0183 Ver.2.0 (DBT : Ver.1.5) DBT, DPT, GGA, GLL, HDT, MTW, MWV, RMC, TLL, VHW, VTG, ZDA
NMEA ports(s)	1 (input / output 1)
Power supply	10.8 to 31.2 V DC
Power consumption	25 W or less (12V DC)
Environmental	
Operating temperature	- 15 °C to + 55 °C
Water protection	IPX5
Store temperature	- 30 °C to + 70 °C
Upper limit of humidity	93 % $\pm$ 3 % (At + 40 °C)
Dimension of equipment (without knob & pedestal)	240 x 240 x 133 mm
Dimension of equipment (with knob & pedestal)	263 x 274 x 133 mm
Weight	3.2 kg

\* Requires data from Temp sensor

\*\* Requires speed data from Speed sensor or GPS sensor

\*\*\* Requires data from GPS sensor



Item	Content
Model	CVS-128B
Output power (RMS)	2 kW
Transducer (Output frequency)	TDM-071 (38 to 75 kHz) TDM-091D (42 to 65 kHz and 130 to 210 kHz)
Selectable frequency range	24 to 210kHz 0.1kHz step
Output method	Single or Alternate
TX rate	3000 times/minute at maximum (In case of single frequency, Range 2.5m and Interference rejection off)
Pulse width	50 $\mu$ s to 3.0 ms
Display size and type	8.4 inch color TFT LCD
Display resolution	640 x 480 pixels (VGA)
Basic ranges	2.5 to 1200 (m), 10 to 3600 (ft), 2.5 to 700 (fm / l. fm) (8 ranges can be set to users choice)
Zoom ranges	2.5 to 200 (m), 10 to 650 (ft), 2.5 to 150 (fm/ l. fm)
Range units	m, ft, fm, l. fm
Shift	Max 2000(m), 6000 (ft), 1100 (fm / l. fm)
Shift step	1m, 10m, 1/8, 1/4
Presentation modes	High frequency, Low frequency, Dual frequency, Zoom image (Bottom lock, Bottom discrimination, Bottom zoom, Zoom, Bottom follow zoom), Nav mode, Vertical split, Horizontal split A-scope can be displayed at all above modes
Presentation colors	64 colors, 16 colors, 8 colors, Monochrome
Back ground colors	Marine blue, Blue, Black, White, Nighttime color, Other 5 colors
Alarms	Bottom, Fish, Temperature*, Speed**, Arrival***, XTE***
Image speed	9 steps & stop
Functions	Interference rejection, Color rejection, VRM, Noise rejection, White line, Draft correct, Water temperature correct, Boat speed correct, Store image (10 images), Sona-Tone™, Fishing Hot Spot, Event memory, Simple plotter, Panel illumination, Power reduction, External trigger, Fish information, Detection area display
Auto functions	Gain, Range, Shift
Function registration	Image speed, A scope, Shift, Interference rejection, Color rejection, Noise rejection, Zoom range, Zoom start, White line, Background color etc
Language	Chinese, English, French, Greek, Italian, Japanese, Korean, Spanish, Thai
Input data formats and sentences	NMEA0183 Ver.1.5 / 2.0 / 3.0 GGA, GLL, HDT, MTW, MWV, RMC, VHW, VTG, ZDA
Output data formats and sentences	NMEA0183 Ver.2.0 (DBT : Ver.1.5) DBT, DPT, GGA, GLL, HDT, MTW, MWV, RMC, TLL, VHW, VTG, ZDA
NMEA input / output port	1 (input / output 1)
Power supply	10.8 to 31.2 VDC
Power consumption	25 W or less (24 VDC)
Environmental	
Operating temperature	- 15 °C to + 55 °C
Water protection	IPX5
Store temperature	- 30 °C to + 70 °C
Upper limit of humidity	93 % $\pm$ 3 % (At + 40 °C)
Dimension of equipment (without knob & pedestal)	240 x 240 x 133 mm
Dimension of equipment (with knob & pedestal)	263 x 274 x 133 mm
Weight	3.2 kg

\* Requires data from Temp sensor

\*\* Requires speed data from Speed sensor or GPS sensor

\*\*\* Requires data from GPS sensor

### 6.3 Appearance

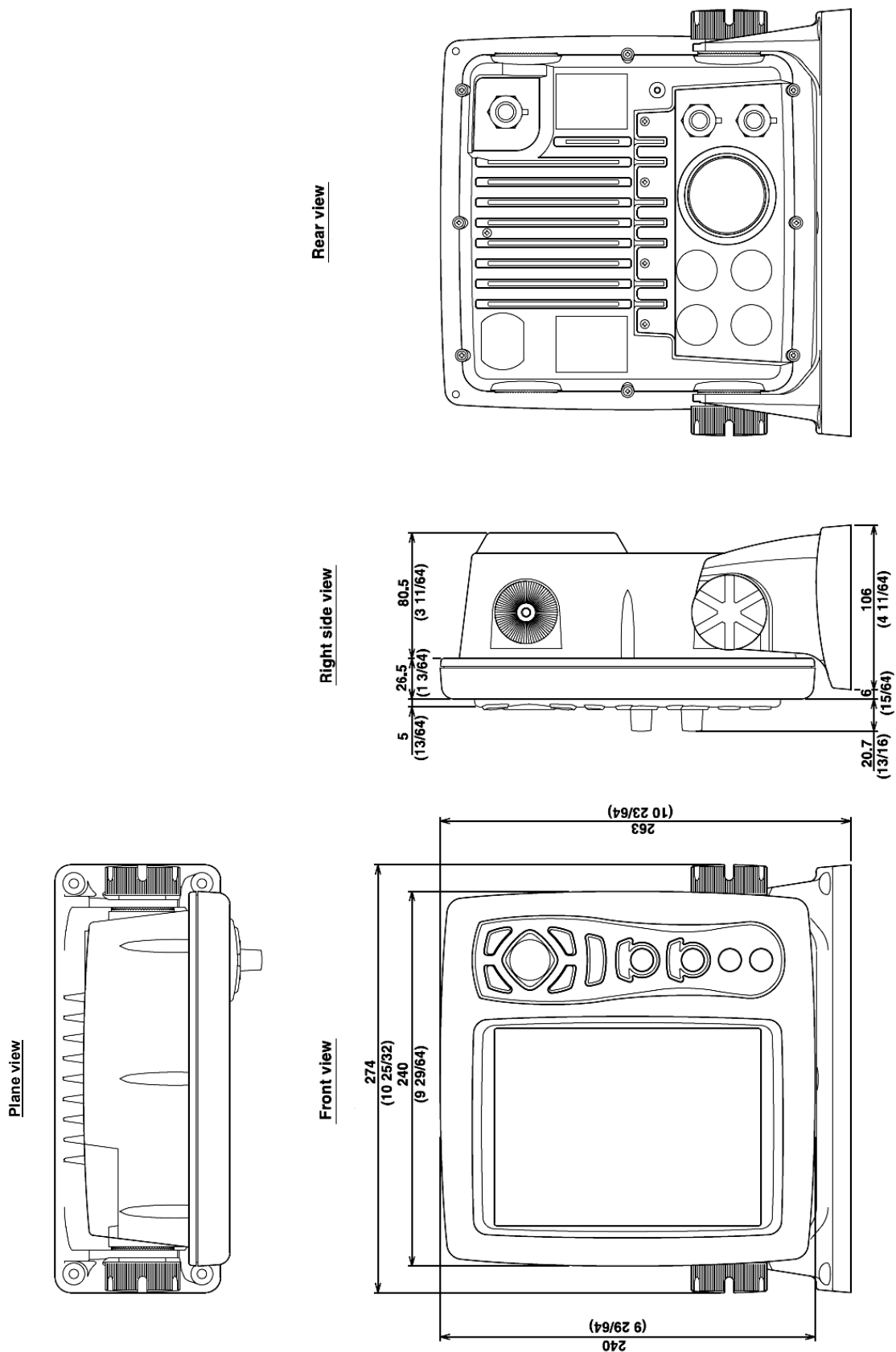





## Koden Electronics Co., Ltd.

**Tamagawa Office:**

2-13-24 Tamagawa, Ota-ku, Tokyo, 146-0095 Japan

Tel: +81-3-3756-6501 Fax: +81-3-3756-6509

**Uenohara Office:**

5278 Uenohara, Uenohara-shi, Yamanashi, 409-0112 Japan

Tel: +81-554-20-5860 Fax: +81-554-20-5875

**[www.koden-electronics.co.jp](http://www.koden-electronics.co.jp)**