

SITEX[®]

MARINE ELECTRONICS

Vector Pro G2 & G2B *GPS Compasses*

Gen III

Installation & Operation Manual



ISO 9001



COMPLIES WITH
CE REGULATIONS

Welcome

Congratulations on your purchase of a SI-TEX Vector Pro G2 or Vector Pro G2B GPS Compass! At SI-TEX, we are dedicated to reliability & quality in all our products, and the Vector Pros are a good example of that. We promise to do our best to ensure your satisfaction with your new Vector Pro GPS Compass.



Warranty Notice

Prior to the installation and/or operation of the equipment, ensure that you read, understand, and accept the conditions of the warranties as detailed in the Warranty Information section of this manual.

General Notice

This document, SI-TEX part number 29010078 Version 2 Revision 0, is the approved Installation and Operation Manual for use with Vector Pro G2 & G2B GPS Compasses. Where versions of this manual exist in other languages, the English version shall be considered authoritative.

Special Note

This manual applies primarily to the third generation of the Vector Pro G2 & G2Bs.

A Vector Pro's generation can be determined by the initial 4 digits of its serial number, which are a "date code" identifying the year and week it was manufactured. The serial number is on the label on the underside of the enclosure.

This third generation's date codes are 0902, or later.

The second generation began at date code 0722 and finished at 0850. For that generation, please refer to any of revisions 1.4 through 1.6 of this manual, and Addendum #1.

It should be noted that much of the information in this manual can be used with the later half of the second generation (date codes 0802 through 0850) – as long as some care is used, since a few features of the second generation differ from the third generation's. For details, see page 89.

The first generation had date codes of 0721 or earlier. For that generation, please refer to revision 1.2 of this manual.

Document History

Revision	Date	By	Description
1R0 -1R2	01 March 2006 <i>through</i> 07 July 2006	DC, et al	first release 1R1 & 1R2: minor edits based on user feedback
1R3	31 May 2007	DTO	added G2B & second-generation information reformatted to new template
1R4	13 June 2007	DTO	added instructions on Baud rate settings for use with SI-TEX autopilots added some more information on configuration options moved the DGPS configuration description into the main body
1R5	14 December 2007	DTO	corrected information in Wiring Diagram and associated table
1R6	04 December 2008	DTO	updated Wiring Diagram & Table to correct for error in OEM cable colour documentation, and to use the correct signal names ('A' & 'B') from the NMEA 0183 standard updated the NMEA Output & Configuration tables with the second-generation Vector Pro commands, & moved them into the main body of the manual, for easier reference updated specifications for the second generation added Warranty Statement updated QMI logo
1R6 Addendum #1	31 March 2009	DTO	contains information on new "SI-TEX factory standard" configuration & related new wiring new information on commands & parameters & usage both taken from draft of v2R0 of manual, and valid for date codes 0902, 0907, up to ~0918
2R0	28 May 2009 DRAFT #3	DTO	valid for date codes 0902 and later (& 08xx, with some caution) updated numerous sections in order to comply with international approval (pending) requirements added diagrams & configuration details for Pitch & Roll expanded Alignment instructions revised Wiring Diagram, added supplementary diagrams for other wiring & usage alternatives added PC serial port & HyperTerminal usage information added examples of command input & typical output data added descriptions of prior generations & cables added CE Declaration of Conformity

About this Manual

This manual provides essential information for the safe and reliable operation of the SI-TEX Vector Pro G2 GPS Compass. You are urged to read this manual in its entirety before you use your GPS Compass for the first time, and to keep it handy until you become thoroughly familiar with the operation of the compass.

Note: most of the information in this manual applies to both models of the Vector Pro G2 GPS Compasses: the Vector Pro G2 and the Vector Pro G2B.

For easier reading, most references in the text use “G2” – but that should always be understood as referring to both models. Whenever a particular item applies only to the G2 or the G2B, it will be so stated in the text of that item.

When using this manual with the Vector Pro G2, please ignore the sections which discuss Radiobeacon signals, Beacon receiver operation and related installation details. Those sections apply only to the G2B.

Manual Format

This manual has been formatted to be printed on both sides of the pages of the manual, and on standard Letter-sized paper (8.5” x 11”).

If you have obtained this manual as a soft-copy, please note that it is in Adobe® Portable Document Format (“pdf”), and so may be viewed & printed with Adobe Reader®, or compatible pdf-format viewers.

When printing this manual with Reader, you should select “duplex printing” (or the equivalent term used by your printer’s software driver), in order to print it double-sided on the paper. If your printer does not have built-in duplexing capability, you can still print this manual double-sided by following the instructions that came with your printer for doing “hand duplexing”.

You should also select the Auto-Rotate and Centre option in the Print Dialog box, de-select the Choose Paper Source by PDF page size option; as well, you should set Page Scaling to None – Reader’s default setting is Shrink to Printable Area, and is printer-dependant (usually set at ~97%), but that is not needed here.

Table of Contents

Welcome	1
Warranty Notice	1
General Notice.....	1
<i>Special Note</i>	1
Document History	2
About this Manual	3
<i>Manual Format</i>	3
Table of Contents	5
List of Figures	8
List of Tables.....	9
Overview	13
Installation	17
Tools Required.....	17
Power Supply.....	17
Environmental Considerations	17
GPS Reception Considerations	18
Radiobeacon Reception Considerations.....	18
Location & Orientation	19
Mounting	21
<i>Fixed Base</i>	21
<i>Pole Base</i>	23
Alignment.....	25
Wiring.....	26
<i>Cables & Extensions</i>	26
Cable Colour Codes.....	27
<i>Power Input</i>	27
<i>Data Connections (Autopilot, GPS Display, Chartplotter, PC, etc.)</i>	28
Serial Ports	28
<i>Outputs</i>	28
RS-422.....	28
RS-232.....	29
<i>Inputs</i>	29
Signal Grounds	29
Serial Port Settings	29
Interfacing to a SI-TEX Autopilot.....	30
<i>SI-TEX SP36</i>	30
<i>5001 System</i>	30
<i>Other SI-TEX Autopilot Systems</i>	30
Interfacing to a SI-TEX Navigator G2 Display System.....	30

Interfacing to a PC.....	32
<i>PC COM Ports</i>	32
D Connector Pinouts	32
DE9 Connectors.....	33
DB25 Connectors.....	33
<i>Using a PC for Vector Pro G2 Control & Display</i>	34
<i>Using a Vector Pro G2 with a PC Navigation Program</i>	34
<i>Using a PC for both Vector Pro G2 Control/Display & a Navigation Program</i>	36
Operation	39
Understanding How the G2 Works.....	39
<i>Automatic & Continuous Operation</i>	39
Acquisition Time.....	39
<i>GPS Signal Reception & Processing</i>	40
Determining Position	40
<i>Differential Corrections</i>	40
Determining Heading.....	41
<i>Moving Base Station RTK</i>	42
Determining Speed and Other Navigation Information.....	42
<i>Supplemental Sensors</i>	43
Tilt-aided RTK	43
Gyro-aided RTK	44
Normal Operation.....	45
<i>Output Ports</i>	45
Output Data Formats.....	46
<i>NMEA 0183 Output</i>	46
<i>Proprietary Output</i>	47
<i>Binary Output Sentences</i>	47
<i>Baud Rate</i>	48
<i>Electrical Interface</i>	48
<i>Alarm Output</i>	48
Watchdog	48
Changing the Configuration.....	49
<i>Making Changes</i>	49
Using HyperTerminal.....	49
Using PocketMAX PC	50
Using a Navigator G2.....	50
<i>Configuration Commands</i>	51
<i>Other Commands</i>	57
<i>Customising & Fine-tuning the Configuration</i>	58
Roll Alignment	58
Biased Alignment(s)	58
Disabling the Tilt Sensor	59
Re-calibrating the Tilt Sensor	59
Disabling the Gyro Sensor	59
Smoothing Output Data with Time Constants	59
<i>Changing the Time Constants</i>	59
DGPS Source.....	61
Baud Rates & Data Bandwidth.....	61

Care & Maintenance	65
Protection of Wires and Cabling.....	65
Periodic Checks.....	65
General Precautions	65
Repair	65
Fuse Replacement.....	65
Appendices	69
Appendix 1.....	69
<i>Specifications</i>	69
GPS Receiver	69
DGPS Beacon Receiver (G2B only).....	69
System Interface.....	70
Power.....	70
Mechanical.....	70
Appendix 2.....	71
<i>Setting Up & Using HyperTerminal</i>	71
Set Up a New Connection.....	71
Save and Re-use the Connection	74
Use the New Connection to the G2.....	75
Example Data Displays.....	75
Monitoring the G2.....	77
Capturing Data Output from the G2	78
Sending Commands to the G2.....	80
<i>Example Responses</i>	84
Appendix 3.....	89
<i>Vector Pro Model Generations</i>	89
Identifying Generations	89
Differences between Generations.....	89
Differences between Cables	91
<i>Cable Usage</i>	92
CE COMPLIANCE	93
Compass Safe Distance Certificate	95
Warranty Information	97
Index	103
User Notes & Settings	107
User Settings	107
Notes	108

List of Figures

Figure 1 – Typical G2 System.....13

Figure 2 – Heading & Pitch Installation (viewed from above).....19

Figure 3 – Heading & Roll Installation (viewed from above).....20

Figure 4 – Mounting using the Fixed Base.....21

Figure 5 – Connecting the Power/Data Cable.....21

Figure 6 – Alignment Pegs.....22

Figure 7 – Fastening the Fixed Base.....22

Figure 8 – Mounting using the Pole Base.....23

Figure 9 – Jam Nut and Washer23

Figure 10 – Pole Base with Cable.....24

Figure 11 – Long-sight Alignment.....25

Figure 12 – Typical Wiring Diagram of a Vector Pro G2 System (with Autopilot & Compass Display)31

Figure 13 – DE9 & DB25 Pin Numbering32

Figure 14 – Typical Wiring with a PC for Vector Pro G2 Control & Display.....34

Figure 15 – Typical Wiring with a PC-based Navigation Program.....35

Figure 16 – Secondary Antenna Search Volume42

Figure 17 – Tilt-aided Search.....43

Figure 18 – Tilt & Gyro-aided Search.....44

Figure 19 – PocketMAX PC GPS Receiver Type Selection50

Figure 20 – Data Bandwidth Estimation62

Figure 21 – New Connection Dialog Box.....71

Figure 22 – COM Port Selection Dialog Box72

Figure 23 – COM Port Settings72

Figure 24 – Disconnect Button.....73

Figure 25 – Call Button.....73

Figure 26 – COM Port Properties Dialog Box, Settings Tab.....73

Figure 27 – COM Port ASCII Setup Dialog Box74

Figure 28 – A Typical Two-session Screen.....76

Figure 29 – Typical Port A Session77

Figure 30 – Typical Port B Session77

Figure 31 – Capturing the G2’s Output.....78

Figure 32 – Choosing a Filename & Location for Captured Output.....78

Figure 33 – Sending a Command File.....80

Figure 34 – Choosing the Command File to Send80

List of Tables

Table 1 – Standard Cable Lengths	26
Table 2 – Cable Colour Codes.....	27
Table 3 – SI-TEX SP36 Connection Details.....	30
Table 4 – PC COM Port (DE9) to G2's RS-232 Port A or B.....	33
Table 5 – PC COM Port (DB25) to G2's RS-232 Port A or B.....	33
Table 6 – Default NMEA Output Sentence Configuration	46
Table 7 – Default Proprietary Output Sentence Configuration	47
Table 8 – Commands for the NMEA Output Sentences.....	52
Table 9 – Commands for the Proprietary Output Sentences.....	52
Table 10 – Commands for the Binary Output Sentences.....	53
Table 11 – Commands for the Beacon Output Sentences (G2B only).....	53
Table 12 – Commands for the Beacon Receiver (G2B only)	53
Table 13 – Commands for the Smoothing Time Constants.....	54
Table 14 – Commands for Baud Rates, Installation Options & Internal Sensors	54
Table 15 – Commands for Miscellaneous Features & Functions.....	55
Table 16 – Commands for Status & Configuration.....	56
Table 17 – Smoothing Time Constants.....	60
Table 18 – Time Constant Formulae.....	60
Table 19 – GPS Receiver Specifications	69
Table 20 – DGPS Beacon Receiver Specifications.....	69
Table 21 – System Interface Specifications	70
Table 22 – Power Specifications.....	70
Table 23 – Mechanical Specifications.....	70
Table 24 – Differences between Vector Pro G2 Generations.....	90
Table 25 – Cable Types.....	91
Table 26 – Colour Coding of All Standard Cables.....	91
Table 27 – User Settings (Ports).....	107
Table 28 – User Settings (Alignment & Operational)	107

Introduction

Overview

The Vector Pro G2 GPS Compass is a state-of-the-art electronic navigation data device. It is capable of providing highly accurate, high-precision position and heading data to a wide variety of marine Navigation equipment, such as autopilots, sonar, radar, chartplotters, AIS receivers & transponders, and many other types of marine devices & systems.

The Vector Pro G2 features fast start-up and signal re-acquisition times, heading & position updates at up to 20 times per second, and can operate at sustained turn rates up to 90° per second.

The Vector Pro G2 is a complete GPS Compass in a single rugged, marine-grade enclosure. It needs only one single power/data cable, which greatly simplifies installation.

A typical installation of the G2 looks like this:

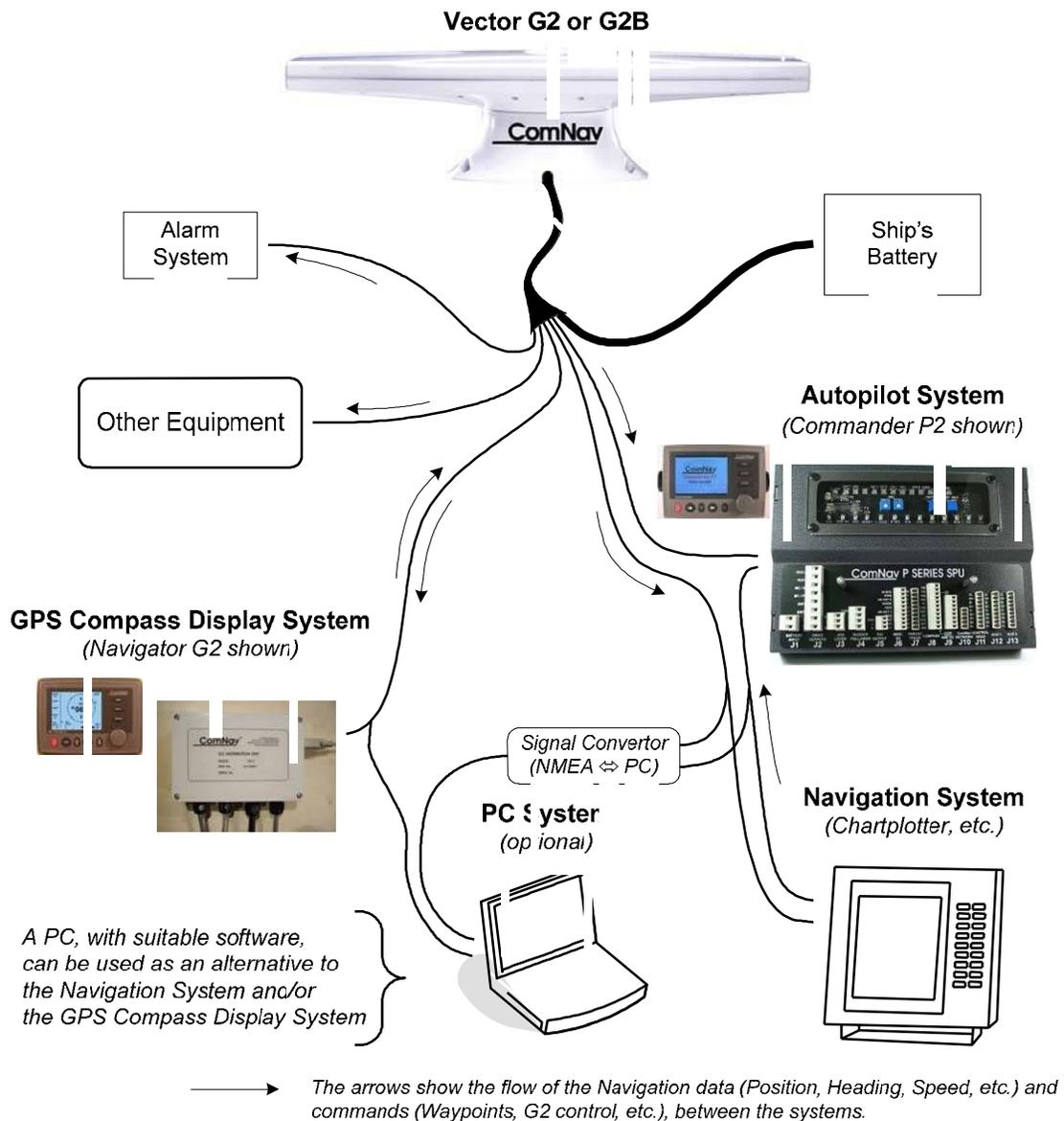

Figure 1 – Typical G2 System

There are two models available – the Vector Pro G2 and the Vector Pro G2B; they are identical, except in their Differential GPS (DGPS) correction features:

The Vector Pro G2 can obtain DGPS information from many Space-Based Augmentation System (SBAS) sources (in areas where compatible ones are available & operational), including WAAS, EGNOS, MSAS, SNAS, GAGAN and others. The Vector Pro G2 can also accept DGPS information from an external data source.

The Vector Pro G2B has an additional integrated beacon receiver module, which allows it to use conventional terrestrial DGPS Radiobeacon signals to obtain DGPS information, in addition to SBAS sources & external DGPS data sources.

The Vector Pro G2's enclosure contains a Hemisphere GPS® Crescent® GPS/SBAS receiver module¹(containing twin GPS receivers, a single-axis gyro & a tilt sensor), dual GPS antennas and a power supply. The Vector Pro G2B also contains a DGPS Radiobeacon receiver module, and an H-field beacon signals antenna.

When using DGPS corrections (SBAS, external, or Radiobeacon), the Vector Pro G2 is capable of one metre precision for position sensing. The GPS antennas inside the G2's enclosure are separated by 0.5 metres, which provides 0.5 degree precision for heading sensing.

The gyro and tilt sensor improve system performance, and can provide heading information for up to three minutes whenever the G2's normal GPS-based heading is not available due to signal blockage, or other temporary factors.

The Vector Pro G2 also features Hemisphere's exclusive COAST™ software, which enables the GPS receiver to utilize old DGPS correction data for 40 minutes or more without significantly affecting the quality of position reports. The COAST feature means that the G2 is less likely to be affected by DGPS signal outages due to signal blockages, weak signals or interference.

If you are new to GPS technology, we recommend that you consult Hemisphere's GPS Technical Reference manual²for further information on the capabilities & general features of their Crescent-based GPS products, before proceeding.

Note: while the Vector Pro G2 & G2B are designed to provide highly accurate GPS position & heading data, even when subject to the pitching, rolling and wide speed range of marine vessels, the use of the G2s is not limited to the marine market.

Other excellent applications include machine control, machinery guidance, container tracking, or indeed any application that requires high-precision position and/or heading information in an all-weather outdoor environment.

The Vector Pro G2 is factory-configured for easy use in typical marine situations, such as illustrated in Figure 1. The goal when the factory-default settings were being selected was that the G2 could be used "right out of the box" in most marine applications, with no changes required in configuration settings.

We hope that you will be able to do exactly that ... use your new Vector Pro G2 right out of the box! But if not, then the information in this manual will show you how to adjust your G2 to operate exactly how you want it to.

¹ See Appendix 3 on page 89 for more details.

² This manual can be found on the CD that is supplied with the unit, or on Hemisphere's web site. SI-TEX's Service Department will also send it to you at no charge.

Installation

Installation

Please refer to the Warranty Information section of this manual before proceeding with installation of the Vector Pro G2.

Tools Required

General-purpose tools such as a portable drill, pliers, wire cutters, screwdrivers, wire, mounting bolts and wrenches will be required. An accurate voltmeter or multi-meter would also be useful.

Hazard warning!

Extreme caution is advised when using tools powered by alternating current (AC) from main supply circuits, regardless of whether those circuits are rated for “indoor”, “outdoor”, “marine” or “industrial” use. Water, especially sea water, is an excellent conductor of electricity, and can complete a path to AC Ground through your body, causing injury or death, if a tool malfunctions or short-circuits.

 **Battery powered tools are** STRONGLY recommended 

If AC tools are used, they must be plugged into a circuit that is adequately protected against Ground Faults and other safety hazards, in accordance with local electrical codes.

Power Supply

For reliable operation of your Vector Pro G2 GPS Compass, your vessel's power supply system must have an adequately-breakered, or fused, DC (direct current) power supply at a nominal voltage of 12 or 24 volts. A power on/off switch should also be provided.

Ensure that adequate wire sizes are used to handle the expected maximum currents (see Table 22).

 *It is strongly recommended that the G2's power wiring be run directly from the power supply – especially for 12 Volt systems. The minimum supply voltage is specified as 11 Volts, at the loose-wire end of the G2's cable. On a “12 Volt” battery system, it is possible (if the battery is weak or partially discharged, and if there are other loads along the wiring from the battery to the end of the G2's cable) that the cable-end voltage will drop below 11 Volts. In such circumstances, the G2 may exhibit erratic behaviour, such as periodic resetting.*

Environmental Considerations

Ensure that the G2's Operating & Storage Temperature Ranges are not exceeded (see Specifications, Mechanical, on page 70).

The G2 will operate up to 100% relative humidity. The G2's case, cable & mount are waterproof – but they are not submersible.

GPS Reception Considerations

The following points relating to GPS reception must be considered:

Mount the G2's enclosure as high as possible, considering maintenance and accessibility. Ensure that there is an unobstructed as possible "view" of the sky available to the unit, to avoid blocking the RF signals from the GPS satellites. It is important to locate the G2 as far away as possible from any metallic surfaces that could reflect the RF signals from the GPS satellites.

- ® Such surfaces, if they reflect the RF signals at "just the right" angle(s), can cause a condition known as multi-pathing on the signals – which in turn will randomly degrade the G2's heading performance and accuracy.
- ® In particular, there must not be, within a distance of 2 metres of the G2, any metallic surfaces which are located above the horizontal plane of the enclosure.

It is also important to locate the G2 away from any transmitting antennas for any RF signals (e.g., VHF, SSB, Radar, etc.), by at least a few metres. This is to ensure that the Vector Pro's internal electronic circuits do not experience induced RF noise, so that its performance is not compromised.

- ® If the case of a Radar system, you must also be sure to mount the G2 outside the direct path of the radar beam – typically, that is a conical shape which extends outwards from the Radar emitter, and sweeps over a full 360° horizontal circle.

The G2's enclosure should be mounted as close as possible to horizontal (when the boat is at rest in calm water – e.g., at dockside). This is to ensure that the G2's internal Tilt sensor can determine the attitude of the enclosure (& thus the vertical relationship of the two internal antennae).

- ® A configuration parameter can be used to compensate for any offset from horizontal, if necessary (see PBIAS on page 55).

The Vector Pro G2 computes its position as the geographic location of its internal Primary GPS antenna; that antenna is in the end of the enclosure opposite the end which has a recessed arrow on the underside & the long-sight alignment post on the top-side (see Figure 2 & Figure 11). Thus, you should mount the G2 so that the Primary antenna's end is at the location on the vessel where you desire the vessel's "reported GPS position" to be.

Radiobeacon Reception Considerations

For the Vector Pro G2B, it is also important to choose a mounting location with a total view, all around & right down to the horizon, which is as unobstructed as possible, to avoid blocking DGPS Radiobeacon signals from any transmitters within range.

You also will need to consider mounting locations from the perspective of minimizing Electromagnetic Interference (ambient electrical and radio-frequency noise) in the Terrestrial DGPS Radiobeacon band, in order to maximize the Beacon receiver's performance.

The optimum location for the G2B will be a position where it receives the strongest average Radiobeacon signal, with the lowest average EMI.

Ensure that the G2B is located as far as possible from all other equipment that can emit EMI – in particular: DC motors, alternators, solenoids, radios, power cables, display units and other electronic devices.

The G2B calculates the Signal to Noise Ratio (which can be thought of as the "height" of the signal above the noise floor) of the Beacon signals; the higher the SNR, the better. If your installation includes a way to control & monitor the G2B, you can observe the SNR values – see the \$GPCRQ & \$CRMSS sentences in the Beacon Receiver Commands section in the GPS Technical Reference. You should have all equipment & accessories that you intend to use during normal operation turned on, while doing this.

Location & Orientation

There are two primary mounting orientations for the Vector Pro G2:

Normally, the G2 will be mounted so that the longitudinal axis is aligned with the vessel's fore-aft centreline, or is parallel to that centreline. In this orientation, the G2 can output both the Heading and the Pitch of the vessel.

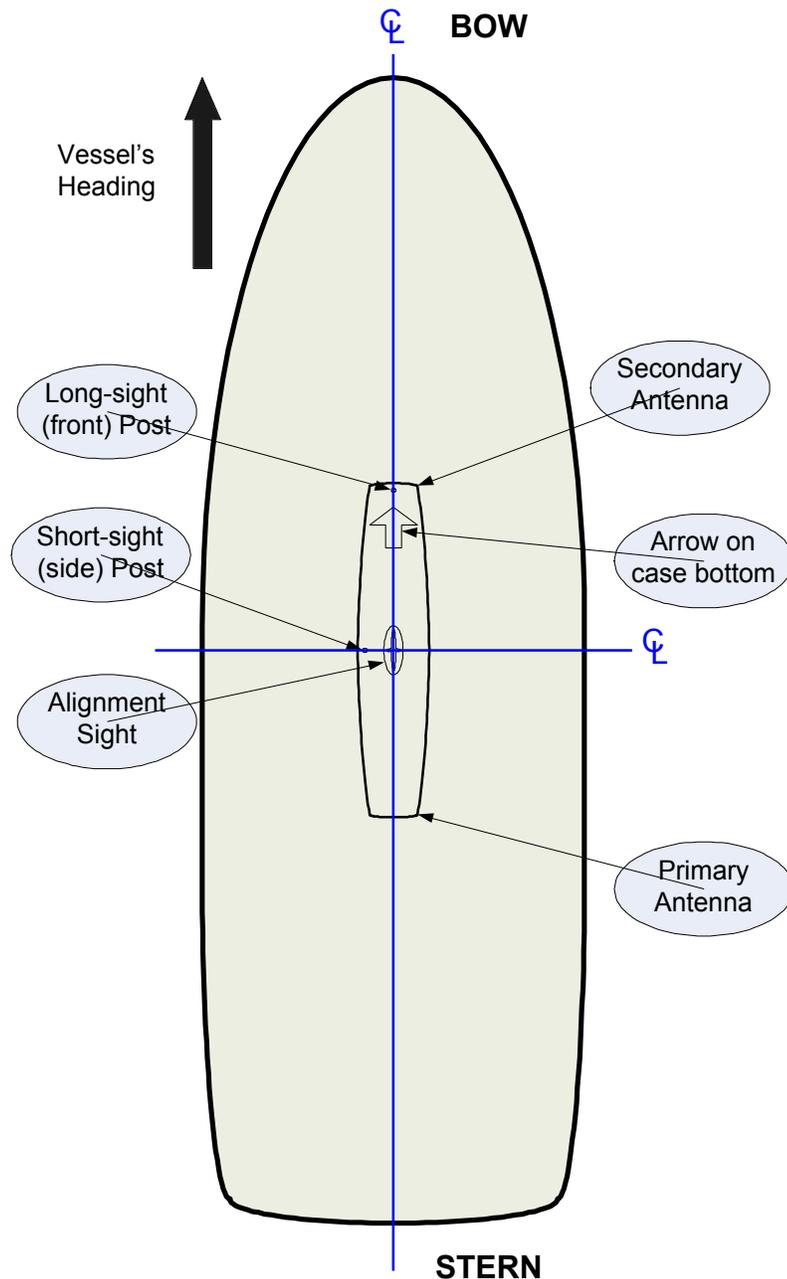

Figure 2 – Heading & Pitch Installation (viewed from above)

If you wish, you can instead install the G2 perpendicular to the vessel's fore-aft centreline, i.e., on (or parallel to) the athwartships centreline. In this orientation, the G2 can output both the Heading and the Roll of the vessel.

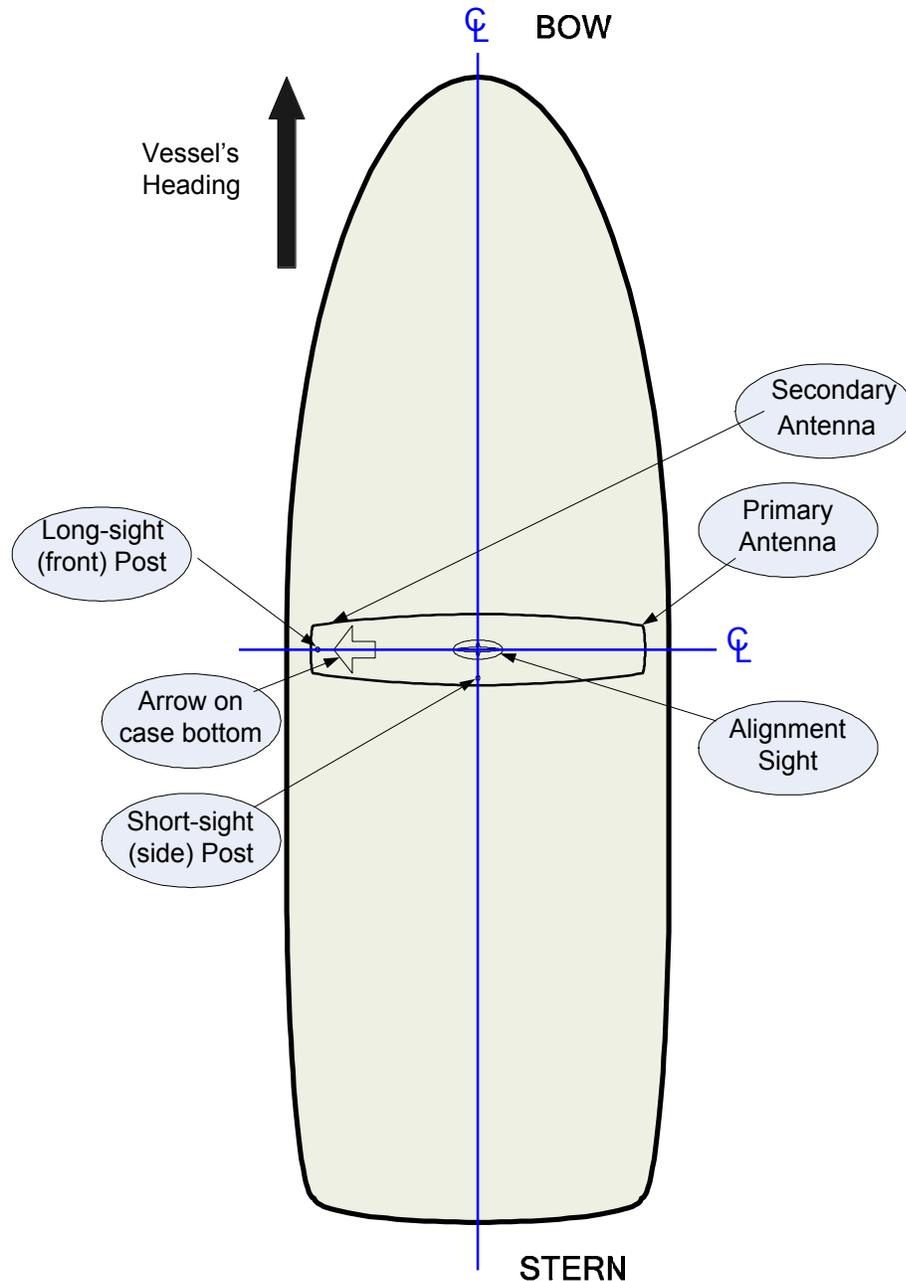

Figure 3 – Heading & Roll Installation (viewed from above)

Note: you must also reconfigure some of the G2's configuration parameters in this orientation (see Roll Alignment on page 58, and the GPS Technical Reference).

The figure shows the G2 pointing to the vessel's Port; you could also mount it pointing to Starboard.

Mounting

The Vector Pro G2 can be mounted on a fixed base, or on a pole; parts for both options are provided with system kits:

The fixed base option is for mounting the G2 on a flat surface – a cabin roof, a mounting plate on the mast, and so on.

The pole option is easier to use when there is no location with enough un-obstructed flat space to accommodate the fixed base (and/or the G2 itself), or when it is desired to mount the G2 high up above all surfaces.

In either case, make sure that you have enough cable length to route the G2's interface cable as far as required into the vessel (see Cables & Extensions on page 26 for more details).

Fixed Base



Figure 4 – Mounting using the Fixed Base

- 1) Use the fixed base's four slotted edge-mounting holes (at the four corners of the base) as a template; position the base so that it is aligned as closely as possible to the orientation you want. Then mark and drill holes in the flat surface, for the fasteners (not supplied) which you will be using to fasten the base to that surface.
- 2) The fixed base has a choice of four tunnels for routing the G2's power/data along the mounting surface. Or, you may want to route the cable directly through the surface; if so, drill a fifth hole – de-burred, & with diameter at least slightly larger than the G2's cable – in the surface, approximately where the centre of the fixed base will be.
- 3) Run the connector end of the G2's power/data cable through the centre opening in the fixed base, from the bottom side.
- 4) Align the keyway in the cable's plug connector to the key in the G2's data/power connector, and then press them together, fully seating the plug. Align, then engage & rotate the cable connector's locking ring (clockwise rotation to lock, and counter-clockwise to un-lock), until you feel a definite "click".



Figure 5 – Connecting the Power/Data Cable

- 5) There are two pegs on the top of the base that mate with holes on the bottom of the G2's enclosure. Match the pegs to the holes, then press the base onto the enclosure.

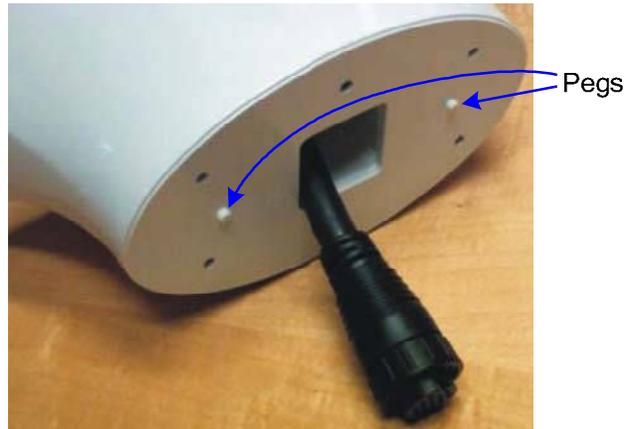

Figure 6 – Alignment Pegs

- 6) Use the supplied TORX bit to fasten the base to the enclosure, using the screws supplied. These screws self-tap a thread in the matching blind screw holes (6 holes) of the enclosure. Fasten the screws firmly, but be careful not to over-tighten, or you may strip the self-tapped threads.



Figure 7 – Fastening the Fixed Base

Caution! *The base is not intended to be removed & re-fastened frequently. If you remove & re-fasten the base from/to the enclosure too often, you may strip the self-tapped hole threads. Stripped threads are not covered under the Warranty!*

- 7) Route the free end of the G2's cable, from the location where you are mounting the G2, along (or through) the mounting surface &/or any bulkheads (as necessary), as far as required into the vessel. Leave enough slack to allow removal of the G2 from the fixed base from the mounting surface, should that ever be necessary.
- 8) Install the fixed base on the flat surface, using four suitable screws or fasteners of your choice (SI-TEX recommends that they be corrosion-resistant). Do not tighten down the base-to-surface screws all the way just yet; leave them just loose enough so that you can swivel the base, within the slotted holes, when you are doing final alignment (see page 25).

Pole Base



Figure 8 – Mounting using the Pole Base

- 1) Install a threaded mounting pole at the location you have chosen. The pole must be supplied by you; it must have an appropriate height for the location, and must have 1-14-UNS threads on one or both ends. If you are mounting the pole on a surface, drill & de-burr a hole in the surface, centered in the pole, with a diameter at least slightly larger than the G2's cable.
- 2) Fasten the pole securely to the vessel, using appropriate fasteners, clamps, etc. of your choice; SI-TEX recommends that all hardware be corrosion-resistant.
- 3) Thread the supplied 1-14-UNS threaded hex jam nut, and then a suitable flat washer, onto a 1-14-UNS threaded end of the mounting pole – the end which will be the top end of the pole.



Figure 9 – Jam Nut and Washer

- 4) Route the free end of the G2's power/data cable through the centre hole in the pole base, from the top side of the base. Then route it down through the pole, and on through any surfaces &/or bulkheads (as necessary) – as far as required into the vessel. Leave some slack in the cable, below the bottom of the pole – enough to allow you to move the connected cable a short ways out of the pole, for easier removal of the G2 from the pole &/or pole base, should that ever be necessary.



Figure 10 – Pole Base with Cable

- 5) Thread the pole base onto the threaded pole, four to five full turns. Do not tighten up the jam nut just yet.

Caution! Do not bottom out the pole base on the threaded mount. This can damage the base.

- 6) Align the keyway in the cable's plug connector to the key in the G2's data/power connector, and then press them together, fully-seating the plug. Align, then engage & rotate the cable connector's locking ring (clockwise rotation to lock, and counter-clockwise to un-lock), until you feel a definite "click".
- 7) There are two pegs on the top of the base that mate with holes on the bottom of the G2's enclosure. Holding the enclosure in approximately the final orientation desired, rotate the pole base & nut/washer combination so that the base is in the same orientation (i.e., so that the base's pegs can mate with the enclosure's holes), then press the enclosure down onto the base.
- 8) Use the supplied TORX bit to fasten the base to the enclosure, using the screws supplied. These screws self-tap a thread in the matching blind screw holes (6 holes) of the enclosure. Fasten the screws firmly, but be careful not to over-tighten, or you may strip the self-tapped threads.

Caution! The base is not intended to be removed & re-fastened frequently. If you remove & re-fasten the base from/to the enclosure too often, you may strip the self-tapped hole threads. Stripped threads are not covered under the W arranty!

⚠ The pole mounting option does not meet IEC 60945, section 8.7 ("ability to withstand vibration").

Alignment

Adjust the orientation of the Vector Pro G2 as necessary, and then secure it when complete:

The four slots in the fixed base allow for several degrees of adjustment of the orientation of the enclosure. When you have obtained the desired orientation, tighten down the fasteners that you used in the slots securely.

The pole base can be rotated freely on the pole, as long as the jam nut is loose.

When you have obtained the desired orientation, tighten the jam nut securely (use a wrench!).

Caution! Use of the jam nut and a suitable flat washer are mandatory for pole mounting. Any damage resulting from not using these to mount the G2 will not be covered under the Warranty.

The top of the G2's enclosure incorporates two small pointed posts and an alignment sight, to assist you in aligning the enclosure's orientation. To use the sight:

look along the top of the enclosure & across the sight:

- either from the end without a post (i.e., the primary antenna end):
 - Š then centre the other end's post (the Long-sight shown in Figure 2, Figure 3 and Figure 11) in the length-wise groove in the Alignment sight
- or from the middle of the long side without a post:
 - Š then centre the other edge's post (the Short-sight, shown in the same figures) in the width-wise groove in the Alignment sight

the sight-line you see is the centreline of the enclosure ... either length-wise when using the Long-sight, or width-wise with the Short-sight

adjust the direction of the enclosure's sight-line to be parallel to the vessel's centreline:

- either the fore-aft or athwartships line, whichever you have chosen to use
- or perpendicular to one of those centrelines

alignment accuracy when using the Long-sight method is approximately $\pm 1^\circ$

using the Short-sight method, alignment is accurate to approximately $\pm 2.5^\circ$

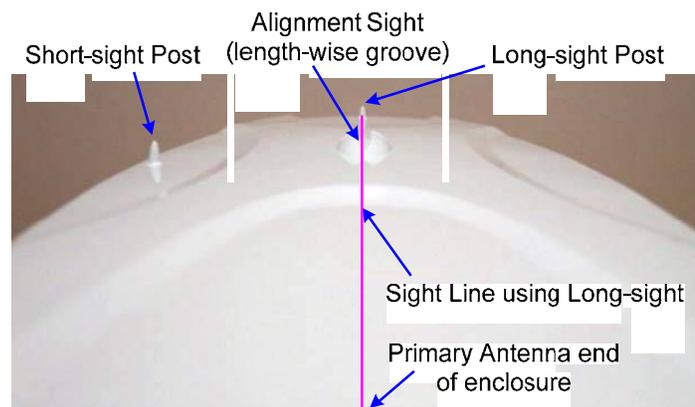

Figure 11 – Long-sight Alignment

If you have another accurate source of heading data on your vessel, you may use the difference between the G2's initially-reported heading value and that of the other compass, to correct for any bias in the G2's alignment, by entering the difference value in the G2's heading bias parameter (see HBIAS on page 55 and page 58). You could also obtain a bias value by doing a traditional "box the compass" run.

Alternatively, you may wish to physically adjust the direction of the G2's enclosure, by that "other accurate compass" bias value, so that the G2 does not have any bias in its "parallel to (or perpendicular to)" alignment.

 *Using the G2's heading bias parameter is usually the easier way!*

Wiring

A single cable, included with the Vector Pro G2, supplies power to it, and also carries NMEA 0183 data & control signals from & to it. The G2 end of the cable is an environmentally sealed, mechanically-keyed/locking connector; the other end is un-terminated, and requires field stripping and tinning.

The cable should be wired to your vessel's autopilot, and/or other equipment of your choice that can use NMEA 0183 data. Some typical examples are shown in Figure 12, Figure 14 and Figure 15.

When choosing a route for the cable:

- Keep the cable well away from rotating machinery
- Avoid running the cable in areas of excessive heat
- Keep the cable away from corrosive chemicals
- Do not run the cable through door or window jams
- Do not excessively bend, or crimp, the cable
- Secure the cable along the route using plastic tie wraps as necessary

Cables & Extensions

There are two standard cable lengths supplied with the Vector Pro G2:

Part Number	31110039	31110040
Length	15 metres	30 metres
Marking 1	051-0157-002	051-0158-001

Table 1 – Standard Cable Lengths

- 1 *The Marking is on a plastic sleeve located near the connector. It is the only way to identify the cable, since the Part Number does not appear on it.*

If the standard-length cable supplied with your kit is too long, you may shorten it as required.

If the standard-length cable is too short for your installation, longer cables are available on special order (contact your SI-TEX dealer for details).

Alternatively, you can route the cable into a customized break-out box with internal terminal strips, to a simple set of strips mounted on a bulkhead or other surface, or use good-quality soldered or crimped, marine-grade, wire-to-wire connection techniques.

Or, if you are using the G2 with a Navigator G2 GPS Compass Display, the latter's Distribution Unit has a terminal strip for connecting an extension cable.

But, no matter which extension cable connection method you use:

The cable should be similar to the standard cable (shielded, marine grade).
The extension's serial data (both RS-232 & RS-422) & alarm wires should be at least 20 AWG, and the respective pairs of signals (see Table 2) should be twisted in pairs.

- ® The total length of RS-232 signal wires (cable plus extension) should be no longer than industry standards for such cables, although the specific maximum length may depend on what equipment you are wiring them to; for example, PCs (especially laptops) often can not handle more than about 25 metres of RS-232 wiring.
- ® The RS-422 signal wires can support much longer cable runs than the RS-232 wires, since that standard provides for more immunity to noise and attenuation.

The extension's power input wires should be at least 18 AWG, to ensure that there is minimal additional voltage drop in the extension (see Table 22).

Cable Colour Codes

Cable Marking: 051-0157-002 (15 metres), 051-0158-001 (30 metres)		
Wire Colour	Signal	Description
Red 1	n/a	Power Input
Black 1	n/a	Power Ground
Blue	RS-232, Tx	Port A Transmit
Black, Blue stripe	RS-232, Rx	Port A Receive
Black, Green stripe	RS-422, 'A'	Port A Transmit
Green	RS-422, 'B'	
Brown	RS-232, Tx	Port B Transmit
Black, Brown stripe	RS-232, Rx	Port B Receive
Yellow, Black stripe	RS-422, 'A'	Port B Transmit
Yellow	RS-422, 'B'	
Grey	RS-232, Gnd	Signal Ground
White	n/a	Alarm Output Pin 1
White, Red stripe	n/a	Alarm Output Pin 2
Bare Wire 2	n/a	Drain for RF Shielding !! Do NOT CONNECT !! e

Table 2 – Cable Colour Codes

- 1 The Power Input & Ground (Red, Black) wires are 18 AWG; all the other insulated wires are 24 AWG.
- 2 The Drain wire on the 30m cable is insulated with black heat-shrink.
- e The Drain wire should never be connected – see page 29.

Caution! The coloured “stripe” shown above is either repeated bands of the colour, or a thin spiralling stripe. The stripe can be very hard to see (especially the Blue, Green & Brown stripes, all on Black backgrounds); please inspect the wires carefully, under a good light, to be sure you are using the right wires!

Note: there were two earlier generations of the Vector Pro G2 & G2B. The earlier generations used slightly different colour-coding in their standard cables, & had different cable markings, than shown above. The older cables can be used with the current generation, with some cautions; see Differences between Cables in Appendix 3 on page 91 for details.

Power Input

A 3 Amp fast-blow fuse or circuit breaker (not supplied) should be installed in series with the Power Input wire. An in-line On/Off switch (not supplied) capable of handling 3 Amps should also be installed (if a breaker is installed, it may be permissible at your locale to use it as the On/Off switch).

The breaker/fuse/switch and all the power wiring must be done in accordance with the applicable electrical safety standards for “low-voltage DC” wiring at your locale.

Caution! The Vector Pro G2’s power supply is protected against reverse polarity power input – but the G2 will not operate with reverse polarity.

Note: the G2’s power supply is isolated from all the data communication lines. As well, the plastic enclosure isolates the G2’s circuitry galvanically from the vessel – which helps reduce hull electrolysis problems.

Data Connections (Autopilot, GPS Display, Chartplotter, PC, etc.)

There are a number of ways to make the data connections required between the Vector Pro G2 and other equipment on the vessel. See Figure 12, Figure 14 and Figure 15 for examples:

The G2 is typically used with a SI-TEX Autopilot System (e.g., SI-TEX SP36, Admiral P3, 2001, 5001, etc.), an optional SI-TEX Navigator G2 GPS Compass Display System, and a generic Chartplotter or other type of Navigation System.

- ® A PC can be used, instead of the Navigator G2 Display, to configure the Vector Pro and/or monitor its status.
- ® A PC can be used, instead of a Chartplotter or other type of NMEA Navigation equipment, to perform the “Navigation display & control” functions – setting waypoints, etc.

Each of those connection schemes is described in more detail below. Other schemes may also be possible on your vessel, or in your application of the G2.

All data communications from/to the G2 is done with serial data signals; there is also a separate Alarm signal from the G2, using the contacts of a relay.

Serial Ports

The G2 has two serial ports, denoted as “Port A” & “Port B”.

The serial ports are full-duplex – they can transmit & receive simultaneously.

Outputs

The G2 can output an extensive set of standard and proprietary NMEA 0183 sentences on the serial ports – geographic position & vessel heading data, status of the visible GPS satellites, internal sensor data, Beacon data & status, and so on.

The G2 is factory-configured to output “general Navigation data” on Port A, and “Autopilot data” on Port B. You may change the configuration, if you wish (see page 49 for full details).

Each port’s output (Transmit) is duplicated, with one connection at the RS-422 electrical levels specified in the NMEA 0183 Standard, and the other at the RS-232 levels typically used for computers. Both of the outputs from a Port always have the same data signals & timing, irrespective of electrical level.

The choice of which electrical level(s) to use depends on the serial port type(s) supported by the other equipment you wish to connect to. You may find that the other equipment needs one or the other type, or a mixture of both.

RS-422

Most marine equipment will require using the G2’s RS-422 output(s) – for example, SI-TEX SI-TEX SP36, Admiral P3 and 5001 Autopilots all require RS-422 levels on their Heading, **Speed & NAV input ports.**

The G2’s RS-422 ports are Talkers (i.e., transmit only), in accordance with the NMEA 0183 Standard (version 3.01), and the matching international Standard IEC 61162-1.

RS-422 uses a pair of balanced signals³, in paired wires, with the ‘A’ signal on one wire & the complementary ‘B’ signal on the other.

It is necessary to maintain the correct signal polarity, when connecting one of the G2’s RS-422 output wire pairs to an NMEA 0183 Listener:

- ® The G2 output port’s transmit data ‘A’ signal wire must be connected to the **receive data ‘A’ input terminal of the other device; similarly, the G2’s ‘B’ output wire must be connected to the ‘B’ input terminal of the other device**.⁴

³ All the G2’s RS-422 output signals are referenced to the G2’s RS-232 Signal Ground, although it is usually not necessary to connect that Ground to the other device, if using only the RS-422 outputs (see page 29).

⁴ ... the ‘A’ connection is often labelled “Positive” (or “+ve”, or just “+”), and the ‘B’ as “Negative” or “-ve” or “-”.

RS-232

The only electrical standard specified in NMEA 0183 is RS-422. However, it is common for non-marine equipment to be able to accept NMEA-formatted data – not at RS-422 levels, but only at RS-232 levels; for example, the “COM port” on a PC is always at RS-232 levels.

Such equipment (often described as being “NMEA compatible”) will require using one or both of the G2’s RS-232 outputs.

The G2’s Transmit (Tx) signal wire(s) must be connected to the Receive (Rx) pin(s) of the other device.

Inputs

Both ports’ Receive inputs (Rx wires) are at RS-232 levels only.

The Receive inputs are used for controlling the G2 (with commands sent to it on Port A – to enable sentences, set update rates, set Baud rates, etc.), and for firmware upgrades (via the input of Port B).

Either port may also be used for receiving DGPS correction data (RTCM SC-104) from an external-source – see page 40.

If you are going to use the G2’s RS-232 input connections, the Tx signal wire(s) from the other device must be connected to the Rx wire(s) of the G2.

Signal Grounds

Whether or not to connect the G2’s Signal Ground to the Signal Ground (or the Main or Power Ground, if there is no Signal Ground) of the other device or devices on your vessel depends on how your vessel, and any other equipment, is wired.

RS-422: per the NMEA 0183 Standard, the Listener will have optically (or galvanically) isolated RS-422 inputs; thus, it is usually not strictly necessary – and sometimes it is not even possible – to connect the Grounds.

® For example, the SI-TEX SP36’s NAV1/2 inputs (NMEA 0183 Listeners) are optically isolated – no Signal Ground pin for those inputs is provided.

In contrast, for the P2’s NAV output (which is an NMEA Talker), there is a Ground pin – but that is a “current-controlled, AC-coupled” ground, not the P2’s main Signal Ground.

RS-232: the G2’s RS-232 Signal Ground **MUST** be connected to the other device’s Signal Ground, when using the RS-232 ports.

Caution! The G2’s RF Shield wire (the bare wire in the cable) must not be connected at the other device, no matter whether RS-422 or RS-232 signal wires – or both – are being used. Cut it back near the end of the cable’s outer jacket, and insulate the stub with electrical tape.

On the other hand, it is sometimes better – from the perspective of signal integrity and/or electrical noise-reduction – to connect some or all of the Grounds in a system.

Consult your SI-TEX Dealer for help, if you are unsure what will work best on your vessel.

Serial Port Settings

Both ports use ordinary asynchronous serial data formatting, as specified in the NMEA 0183 Standard; the formatting is fixed, and can not be changed:

1 Start Bit, 8 Data bits, No Parity Bit & 1 Stop Bit (commonly described as “8-N-1”).

The baud rates of the G2’s serial ports must be the same as the device(s) to which they are connected. The factory-default configuration is 4800 Baud on both ports – per the NMEA 0183 Standard.

The baud rates can be changed, if you need to; also, Port A and Port B may have different Baud rates. See pages 48 & 61 for more details.

Interfacing to a SI-TEX Autopilot

SI-TEX SP36 or Admiral P3

Figure 12 shows the typical connections used with a SI-TEX SI-TEX SP36 Autopilot System (an Admiral P3 would be wired identically), a SI-TEX Navigator G2 GPS Compass Display System, and a generic Chartplotter or other type of Navigation System.

Note: this wiring information assumes that the G2 is in its factory-default configuration: Autopilot data on Port B, and General Navigation data on Port A (see pages 45 & 46).

The wiring from the G2 is to the P2's J9 – NAV I/O connector, as follows (a small image of the connector's label is shown to the left of the table):

Note: all current-build P2/P3 SPUs have an error on this label – but the image below is correct.

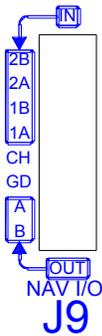

J9 Pin	Wire Color	Signal	Signal	Data Carried
IN-2B	user-supplied 1	RS-422, 'B'	from Chartplotter, etc.	Navigation: Waypoints, Position, etc.
IN-2A	user-supplied 1	RS-422, 'A'		
IN-1B	Yellow	RS-422, 'B'	from G2, Port B Transmit	Heading, Speed
IN-1A	Yellow w/Black stripe	RS-422, 'A'		
OUT-1A	user-supplied 1	RS-422, 'A'	to Chartplotter, etc.	Autopilot status
OUT-1B	user-supplied 1	RS-422, 'B'		

Table 3 – SI-TEX SP36 Connection Details

1 These wires are supplied by the user, thus colours are not specified here.

In addition to the above wiring, the SI-TEX SP36 must be configured to look for both heading and speed data from its NAV1 input port, and for Navigation data from NAV2; for details, see the respective Source selection descriptions for the Standby, Auto & Nav menus, in the P2 Installation & Operation manual.

5001 System

The wiring for a 5001 is similar to that of a SI-TEX SP36: two RS-422 NAV input ports, and one RS-422 output port (the 5001 also has an RS-232 I/O port, but that should not be used with a Vector Pro G2).

All G2 wiring connections to a 5001 must be made at the 5001's Processor Card – see page 4-24 in the 5001's Installation & Operation manual. You must then select the Compass, Speed, and NAV sources (from NAV1, NAV2, according to how you have done the wiring from the G2, a Chartplotter, etc.) – see page 5-15 in the 5001 manual.

It may also be necessary to configure the 5001's COMM port to transmit NMEA output signals, if you need those – see page 5-6 in the 5001 manual.

Other SI-TEX Autopilot Systems

All other SI-TEX autopilots require the use of an optional SI-TEX Sine-Cosine Interface Box (PN 21010004), with matching interface cable (PN 31110023 or 31110051), to use them with a Vector Pro G2.

See the instructions included with the Sine-Cosine Box for wiring and setup information. Note that the G2's Port B RS-422 wires are the ones to be connected to the Converter.

Interfacing to a SI-TEX Navigator G2 Display System

See Figure 12. Wiring of the Navigator G2 is fully described in the Navigator G2's Installation & Operation manual. Note that there is some flexibility in how the wiring between the Vector Pro & the Navigator can be arranged, since part of the function of the Navigator's Distribution Unit is to be a simple, convenient "terminal strip" for the G2.

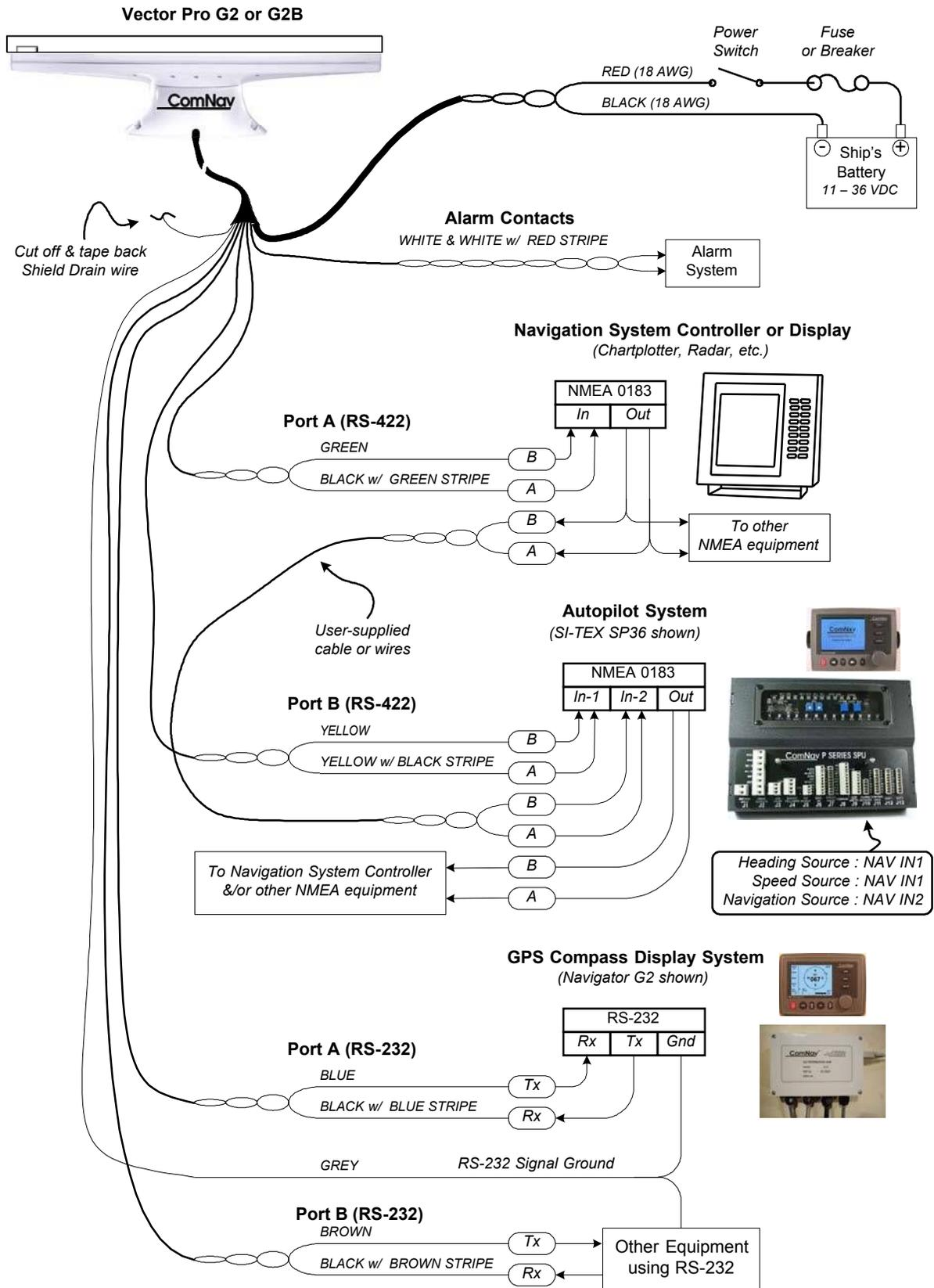

Figure 12 – Typical Wiring Diagram of a Vector Pro G2 System (with Autopilot & Compass Display)

Interfacing to a PC

PC COM Ports

PC serial ports – commonly referred to as “COM ports” – always use RS-232 signal levels, and so the only possible direct connection to the Vector Pro G2 is via the G2’s RS-232 signals.

If it is necessary to connect a PC to any RS-422 signals (for example, when the PC is being used to run a Navigation program, which sends steering commands to an NMEA 0183 autopilot – i.e., at RS-422 levels), a signal level converter will be required (see page 36).

PC COM ports typically use a DE9⁵male (a “pin type”, aka DE9-P) connector; older PCs may use a DB25 (aka DB25-P) connector instead.

Desktop PCs sometimes have 2 (or more) COM ports, although newer models usually only have one COM port. It is possible to add COM ports to most desktop PCs, by adding a suitable “COM Port Expander” card.

Laptop PCs usually have only one COM port.

Many newer PCs – desktops & especially laptops – do not have a real “COM port”. Instead, they only have one or more USB ports, and use driver software to allow application programs to access the USB ports as “virtual COM ports”.

® If the PC only has USB ports, an external USB-to-Serial adapter will be required, since the G2 does not have a USB interface. These adapters typically have a USB ‘A’ size plug at one end, and a DE9 male connector at the other end.

Most brands of adapters should work fine. A number of different ones have been tried at SI-TEX, all with success (in fact, a “USB to 4 Serial Ports” adapter is used by our Production & Testing staff when working on G2s).

D Connector Pinouts

The figure below shows the pin-numbering scheme for a PC COM port’s DE9 & DB25 connectors. This figure can be looked at in two ways:

It is the view from the outside of the PC, looking at the pins of the male connector in the PC, typically located somewhere on the back panel of the PC.

It is also the view of matching female connector (aka a “socket type” – a DE9-S or a DB25-S) when looking at the back – i.e., wire side – of that connector, on the cable that plugs into the PC’s male connector (DE9-P or DB25-P).

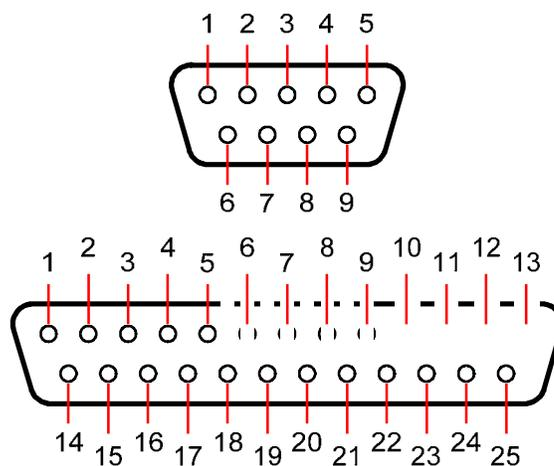

Figure 13 – DE9 & DB25 Pin Numbering

⁵ These connectors are often referred to as “DB9”, but that is technically incorrect. The letters “B” & “E” designate the shell sizes; a B shell is much bigger than an E shell – it can hold up to 25 pins, compared to 9 or 15 pins in an E shell.

DE9 Connectors

To connect either of the G2's RS-232 ports to a PC serial port (or to the DE9-P end of a USB-to-Serial adapter), connect the wires to a DE9 female connector (a "socket type", aka DB9-S) as follows:

DE9 Pin	Wire Color	G2 Signal	COM Port Signal
2	Blue	Port A Transmit data	Receive Data
3	Black w/ Blue Stripe	Port A Receive data	Transmit Data
2 ♀	Brown	Port B Transmit data	Receive Data
3 ♀	Black w/ Brown Stripe	Port B Receive data	Transmit Data
5	Grey	Signal Ground	Signal Ground

Table 4 – PC COM Port (DE9) to G2's RS-232 Port A or B

DB25 Connectors

If the PC has a DB25 COM port connector, connect the wires from the G2 to a DB25 female connector (aka DB25-S) as follows:

DB25 Pin	Wire Color	Signal	COM Port Signal
3	Blue	Port A Transmit data	Receive Data
2	Black w/ Blue Stripe	Port A Receive data	Transmit Data
3 ♀	Brown	Port B Transmit data	Receive Data
2 ♀	Black w/ Brown Stripe	Port B Receive data	Transmit Data
7	Grey	Signal Ground	Signal Ground

Table 5 – PC COM Port (DB25) to G2's RS-232 Port A or B

♀ **Caution!** You can NOT wire both of the G2's RS-232 ports to one PC COM port simultaneously!

You will probably only be using the G2's RS-232 Port A, when connecting to a PC.

However, if you do wish to connect to both of the G2's RS-232 ports simultaneously, you will need to have two COM ports on the PC, with each wired as listed above

Be sure to wire the Signal Ground to BOTH COM ports!

Note: none of the other RS-232 signals that are normally available on PC COM ports (& sometimes used by the ports &/or equipment connected to them), such as the "status" & "flow control" signals (RTS, CTS, DSR, DCD, etc.), are available on, nor used by, the G2's serial ports.

Using a PC for Vector Pro G2 Control & Display

Figure 14 shows the typical connections when using a PC, instead of a Navigator G2 Display, to configure the G2, and/or monitor its status.

Note: the PC is not necessary⁶, if the G2's factory-default configuration (see page 46) meets your needs, and if you do not wish to monitor any of the G2's various status values.

This wiring scheme uses only the G2's Port A RS-232 output and input.

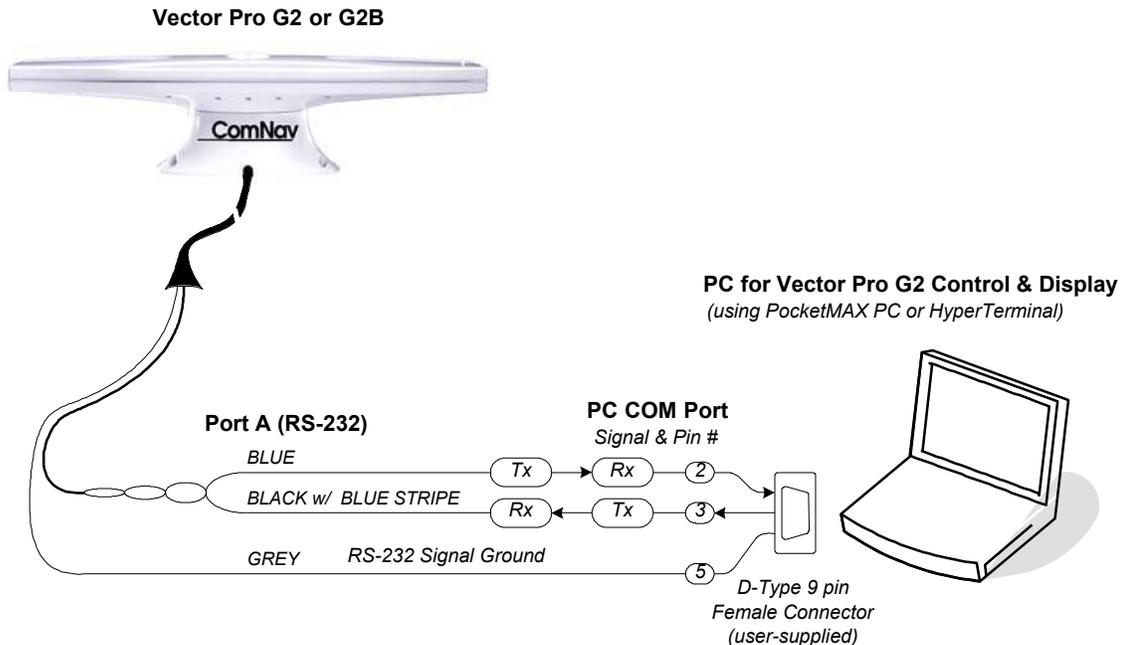

Figure 14 – Typical Wiring with a PC for Vector Pro G2 Control & Display

The PC would typically be running a “dumb terminal” program (e.g., the Hyperterminal® program that comes with Windows® on PCs), or Hemisphere’s own GPS Control & Display program, PocketMAX PC⁷. More details on using Hyperterminal can be found in Appendix 2; see the PocketMAX User Manual for usage instructions on it.

Using a Vector Pro G2 with a PC Navigation Program

Figure 15 shows the typical connections when using a PC, instead of a Chartplotter or some other type of NMEA Navigation equipment, to perform “Navigation display &/or control” functions – viewing the vessel’s position on a chart, setting waypoints and so on.

This wiring scheme uses the G2’s Port A RS-232 output (and input, if the PC is also going to be used to control the G2), and the Port B RS-422 output.

⁶ ... neither is a Navigator G2 Display System, see page 30.

⁷ This program can be found on the CD that is supplied with the G2, and on Hemisphere’s web site. Note that there is also a PDA version of PocketMAX, which can be run on a PocketPC. Use of that version, and wiring a PDA to the G2, are not described in this manual.

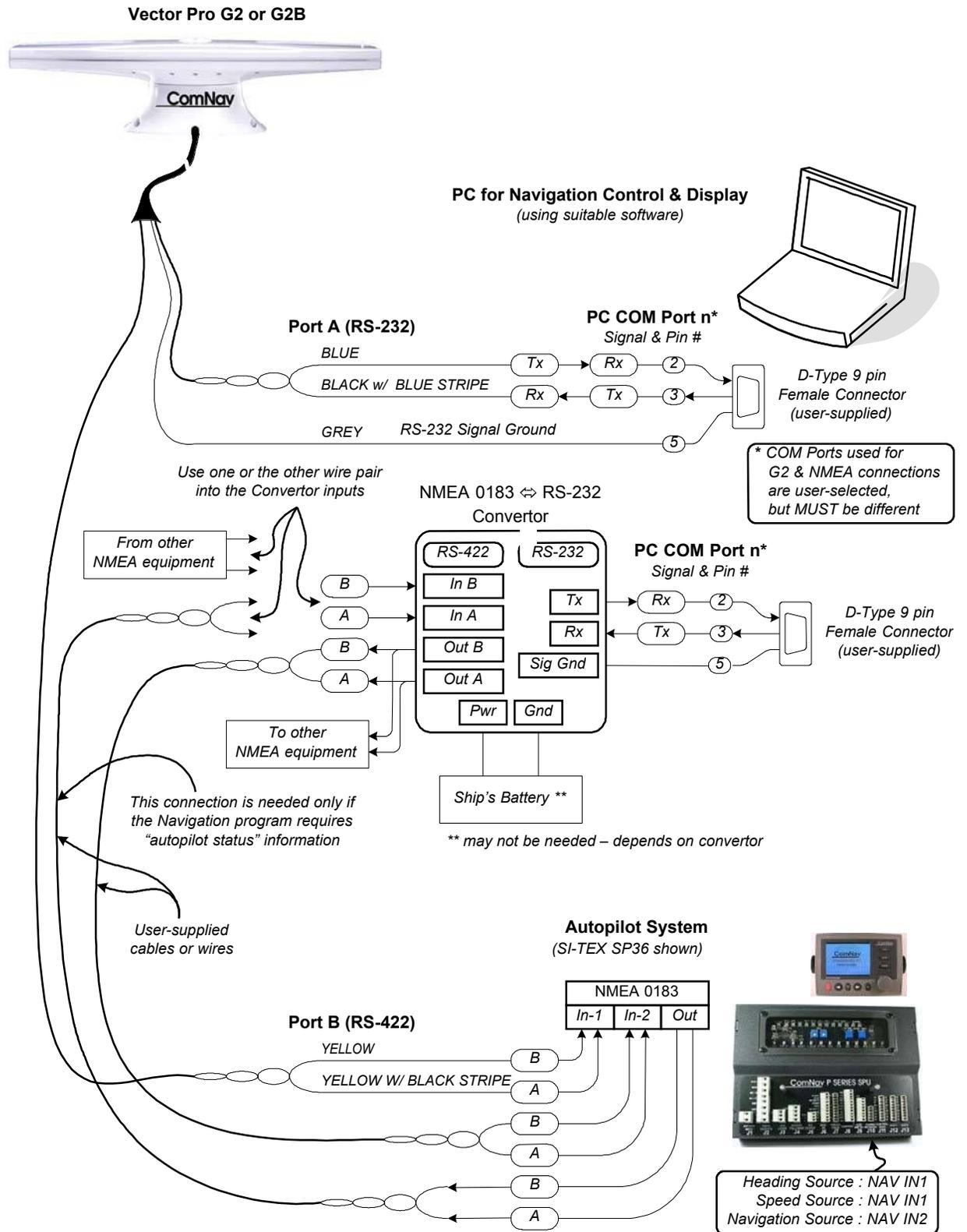

Figure 15 – Typical Wiring with a PC-based Navigation Program

The PC would typically be running a Navigation program (e.g., programs from Fugawi™, Jeppesen®/Nobeltec®, Rose Point Navigation, or similar), replacing the Navigation control functions of (or as a backup to) the Chartplotter.

In this connection scheme, the PC will need to be hooked to the G2 via the latter's RS-232 connections – but it will also usually be necessary to connect the PC to the autopilot and/or other NMEA 0183 equipment, at the NMEA Standard's RS-422 signal levels.

- ® Since very few PCs have built-in RS-422 ports, an RS-232™ RS-422 Converter will usually also be needed (as shown in Figure 15).

Alternatively, if your PC has USB ports, a USB-to-422 adapter could be used for the PC-to-autopilot/etc. connection.

Contact your SI-TEX Dealer for ordering information.

Note: it is sometimes possible to mix the RS-232 electrical levels of a PC's COM port with the NMEA 0183 Standard's RS-422 levels – driving into an RS-422 input from the PC's RS-232 output, and/or vice-versa.

For an example, see the section describing NMEA connections to the SI-TEX SP36 SPU's NAV ports, in the P2's Installation & Operation Manual. This method usually works fine ... on the P2 (& also on the Admiral P3), at any rate.

But it depends largely on the electrical drive capabilities of the PC's COM port circuits. As well, in a technical sense, it violates the rules of the NMEA 0183 Standard, since the voltage levels, signal rise/fall times and circuit impedances of RS-232 and RS-422 are different. It may also cause electrical noise problems – RS-232 is "single-ended" wiring, whereas RS-422 is "differential" (i.e., twisted-pair wires) and thus withstands RFI & EMI electrical noise better.

For those reasons, SI-TEX strongly recommends against mixing RS-232 & RS-422!

However, if you wish to try it with a P2 or P3 SPU:

Wire the G2's Port A RS-232 Tx signal to the PC COM port's Rx signal, and wire the RS-232 Signal Ground, both as shown in Figure 15.

Wire the PC COM port's RS-232 Tx signal to the IN-2A pin of the P2/P3 SPU's J9, and the PC's RS-232 Signal Ground to the SPU's IN-2B pin.

If the PC has only one COM port, but you need to run both "Navigation" & "G2 Control" programs on the PC (see below), you can also connect the PC's Tx signal & Ground to the G2's Port A RS-232 Rx & Signal Ground wires, in parallel to connecting them to a P2/P3.

- ⚠ **Caution! You can NOT do the same for the Rx signal – i.e., connect both the G2's Tx signal and the P2/P3's NAV OUT signal to the PC's Rx pin. Doing so will damage either the G2 or the P2/P3 ... or both.**

- ⚠ *If you encounter any problems with this wiring scheme, use of an RS-232™ RS-422 Converter will then be required.*

Using a PC for both Vector Pro G2 Control/Display & a Navigation Program

The PC can be used simultaneously for both display & control of the G2, and for Navigation display & control. In this scheme, two COM ports on the PC will be required (or multiple USB-to-Serial adapters, or a multi-port USB adapter).

The wiring for this scheme typically will be the same as Figure 15.

Two programs will need to be running on the PC:

One program for Navigation display & control

One program for controlling the G2 and displaying its output

Selection of which COM port on the PC to assign for "Navigation" use, and which port for "Vector Pro G2" use, as well as Baud rates, will depend on the programs used.

Operation

Operation

The Vector Pro G2 GPS Compass provides accurate, reliable, high-precision position and heading data. It is intended to be used with a wide variety of marine Navigation equipment.

The G2 is a very good example of a classic “Black Box”:

There are no switches or indicators on the case ... not even a power light ...

It begins to operate as soon as it is powered on ...

But ... there is NO way to tell if it is working!!

As mentioned in the Overview chapter, the factory-default configuration settings are meant to allow most users, in typical marine applications, to install and use the G2, with no changes needed ... Plug and Play, in other words!

So, in that sense, there’s really no need for an “Operating the Vector Pro G2” chapter in this manual.

On the other hand, since the G2 really is a “Black Box” (despite the case being white ...), there is no way to tell if it is working properly, or to control it, if it is not connected to at least one suitable external device ... such as a GPS Compass Display, or a PC running a suitable program.

And so, the information in this chapter is meant to show how to monitor the operation & status of the G2, and to control it and/or re-configure it, when necessary.

The first part of this chapter will help you gain some understanding of how the G2 works.

The second part describes monitoring & controlling & configuring the G2, and other performance & setup information.

Understanding How the G2 Works

The first thing to do, in order to “operate” a Vector Pro G2, is to turn it on ...

Power should always be applied to the G2 by means of a power switch (in series with a suitable fuse or circuit breaker, see page 27).

Automatic & Continuous Operation

When first powered up, the G2 performs a “cold start” – which involves determining which GPS & SBAS satellites are in view, and then acquiring signals from all that are in view.

The DGPS data source is also automatically acquired, if the G2 has been set to use DGPS data.

Once sufficient GPS signals are acquired, the G2 begins to generate navigational data, which is then sent out on the G2’s two serial ports, according to what it has been configured to output.

While the G2 remains powered, its GPS receivers & processors are always operating.

Acquisition Time

Although initial GPS signal lock may be reached in as little as 30 seconds, it may also take as several minutes, depending on the current positions of the visible GPS satellites and their relative signal strength. During this acquisition time, the position, heading, and other data output may be transmitted on an intermittent basis, causing an “Invalid heading” or similar alarms on navigation devices (such as autopilots and radar displays).

Thus, it is best to turn on the Vector Pro G2 and run it for a few minutes, before turning on your other equipment.

GPS Signal Reception & Processing

The G2 contains a high performance GPS “engine”, containing twin GPS receivers and two multipath-resistant antennas. One antenna is designated as the Primary GPS antenna, while the other is designated as the Secondary. In the G2B, there is also a Radiobeacon antenna (located with the Primary GPS antenna).

The G2 tries to find four or more GPS satellites in the visible sky, and then uses the Radio Frequency signals it receives from those satellites, and the GPS timing & ranging information carried on the signals, to compute its current position, heading, speed, and other Navigation information.

There are two main factors that affect how well the G2 operates:

Satellite visibility ... “a good view of the sky”

Satellite signal quality

Determining Position

The Global Positioning System is essentially a timing-based position triangulation system.

The G2’s GPS receivers automatically and continuously try to receive RF signals from all GPS satellites that are visible in the sky. To determine its own geographic position, the G2’s GPS receivers use a complex algorithm incorporating satellite locations and ranges to each satellite. The ranges are calculated by determining how long it takes for the RF signals transmitted from each visible GPS satellite to reach the G2’s two antennae, using information carried on those RF signals.

If the signal from a visible satellite is of sufficient quality (i.e., strong enough, and with low noise & errors), the G2’s receivers are able to decode the information on the RF signals, and thus to calculate the range to that satellite.

Reception of good-quality signals from at least four GPS satellites allows the G2’s GPS receivers to compute accurate, high-precision 3-dimensional position coordinates.

Positions computed by the G2 are based on the RF phase centre of the Primary antenna (see page 41).

Differential Corrections

There is always some error in GPS positions, from any brand of GPS receiver. Errors can be caused by many things: Selective Availability, atmospheric effects, timing errors and satellite orbit perturbations are some examples.

An ordinary GPS receiver is often specified to be accurate only to about 10 metres for position, because of such errors. But the Vector Pro G2 is more sophisticated than ordinary GPS receivers, and so is inherently much better than that – 2.5 metres or less, when operating in what is referred to as Autonomous mode.

But, to improve the accuracy of position computations even more, the G2 can also acquire and use Differential GPS (DGPS) correction data, from one of several possible sources:

Space-Based Augmentation System (SBAS) satellites, if the G2 is located where one (or more) operational SBAS satellites are visible to it, and if the SBAS data being transmitted by those satellite(s) is valid for the G2’s location.

The G2 automatically scans for and tracks SBAS satellites. It has two-channel tracking capability, which enhances its ability to maintain a lock on a specific SBAS satellite when more than one satellite is in view, and thus provides more consistent tracking.

Current SBAS systems that the G2 can use include WAAS, EGNOS and MSAS; other compatible systems may be operational in future – SNAS, GAGAN, etc.

An external data source sending RTCM SC-104 DGPS data to the G2 (via its RS-232 Port B or Port A).

The Vector Pro G2B can also use:

Conventional terrestrial DGPS Radiobeacon signals.

Marine authorities in many countries around the world have installed networks of Radiobeacon transmitters, which broadcast DGPS corrections valid in the vicinity of each such transmitter.

As well, there is an increasing number of DGPS Radiobeacon transmitters located well inland, which are usable for non-marine applications.

The G2B has a dual-channel Beacon receiver, able to operate in manual or automatic tuning mode, or a database mode; the Radiobeacon receiver is always operating, regardless of the DGPS mode of operation.

When using valid differential corrections, from any of the possible sources, the G2 can improve its position computation to 1 metre or better accuracy.

Determining Heading

Satellite visibility & signal quality are again important to how well the G2 operates, in computing heading. Signals from all visible satellites are used – even any not being used in the position computations described above.

In other words ... the more satellites which are visible, the better!

The Vector Pro G2's GPS engine uses both the data carried on the RF signal from GPS satellites, and measurements of the RF carrier wave's phase, to compute the location of the Secondary GPS antenna in relation to the Primary GPS antenna, with a very high (sub-centimetre) level of precision.

Each of the GPS receivers measures the phase of the RF signal carrier wave, at its own antenna, from each of the GPS satellites it can see in the sky. The phase of the RF waves at each receiver's antenna depends on the distance, and the horizontal & vertical angles, between the satellite and that individual antenna (this can be demonstrated easily with a simple sketch of the physical geometry relationships).

The G2's computed heading is the direction from the phase centre of the Primary antenna to the Secondary antenna's phase centre.

A "heading arrow" is embossed on the bottom of the G2's enclosure. The Secondary antenna is located directly above the arrowhead; the Primary antenna is at the other end.

That means that the arrow points in the direction of the computed heading. This will in turn correspond to actual heading of the vessel, when the G2 is installed on (or is parallel to) the vessel's fore-aft centreline.

When the G2 is installed athwartships, the heading computation is still from the Primary to the Secondary antenna, but then user-set configuration parameters (see Roll Alignment, page 58) are applied, to adjust for the $\pm 90^\circ$ correction required, so that the heading data output correctly corresponds to the vessel's actual heading.

Similarly, if the G2 is not installed exactly parallel to the vessel's centreline – or not quite athwartships – a user-set heading offset parameter is applied.

Note: because the actual phase of the RF waves from the satellites is used, reflections of those waves from nearby surfaces can have a significant adverse effect on the heading performance of the G2

The effect can be thought of as being similar to the "ghost" effect (a faint copy of the image, shifted slightly on the screen) that can sometimes be seen on over-the-air TV signals from distant stations.

On the G2, such "ghosting" – from reflections – can cause the heading computation to become inaccurate, or to fail completely.

 That is why it is so important to mount the G2 as far away as possible from "reflecting surfaces" (see page 18).

Moving Base Station RTK

The technique of computing the location of the Secondary GPS antenna with respect to the Primary antenna, when the Primary antenna is moving, is often referred to as *Moving Base Station Real-Time Kinematic* (or as *Moving-base-station RTK*, or just *RTK*).

RTK technology is very sophisticated and requires a significant amount of real-time computation – in essence “searching” for the correct solution, within a large number of possible solutions, to the mathematical equations which represent the physical relationships of the G2’s two antennae and each visible satellite.

The Vector Pro G2’s GPS engine’s software is able to place a constraint on the RTK solution, because the Secondary GPS antenna has a fixed separation of 0.50 metre, inside the G2’s enclosure, from the Primary antenna.

This separation allows the RTK search (i.e., for the location of the Secondary antenna) to be constrained to the surface of a sphere with a radius 0.50 metre, centered on the location of the Primary antenna.

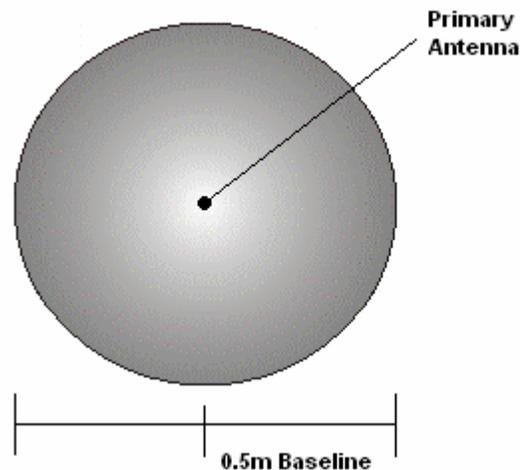

Figure 16 – Secondary Antenna Search Volume

Note: *The G2’s Moving-base-station RTK algorithm uses only GPS signals to calculate heading. No Differential corrections are used in this calculation, and thus the current DGPS source & signal conditions never affect heading accuracy.*

Determining Speed and Other Navigation Information

The balance of the information that the G2 can output is in general computed from the position and heading data, or obtained directly from data or other information provided by the GPS satellites.

For example, speed⁸ is determined from the moment-to-moment changes in the computed position of the Primary antenna’s phase centre⁹.

In contrast, time & date are obtained from data carried on the RF signals from the satellites.

As well, the G2 can output a wide variety of information on the status of the GPS satellites – e.g., how many are currently in view – and on its own status.

⁸ ... more correctly referred to as Speed Over Ground, since it is based on changes in position.

⁹ ... and thus is less accurate at very slow speeds, and is invalid when the vessel is stationary (see page 60).

Supplemental Sensors

Integrated inside the Vector Pro G2's enclosure, on the main printed circuit board, are two sensors. One sensor is an accelerometer, which measures the tilt of the G2's enclosure; the other sensor is a solid-state gyro, which measures the rate of turn.

Both sensors are enabled by default. Each sensor may be turned on or off individually; however, the full functionality of the G2 is realized only when both are used.

Both sensors act to reduce the RTK search even further, which improves heading start-up and reacquisition times, and also improve the reliability & accuracy of selecting the correct heading solution, by eliminating other possible but erroneous solutions.

Tilt-aided RTK

The Vector Pro G2's internal tilt sensor constrains the RTK heading solution to less than the full area of the surface of the search sphere associated with just a fixed antenna separation, since the G2 knows – by reading the tilt sensor – the approximate inclination of the Secondary GPS antenna with respect to the Primary.

The search volume defined by the tilt sensor only (i.e., not factoring in the gyro) will be reduced to a horizontal ring on the surface of the sphere – a considerably smaller area than the full surface of the sphere, as can be seen in the figure below.

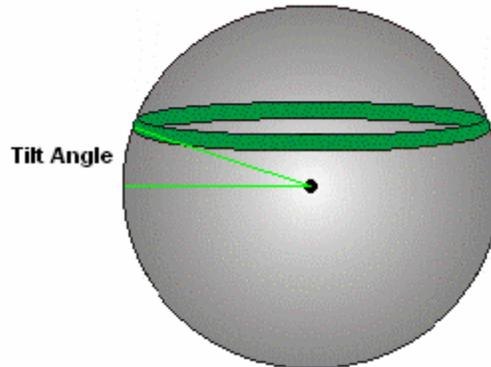

Figure 17 – Tilt-aided Search

The tilt sensor is factory calibrated.

After installation, or after a long period of time that the G2 is in use, or in circumstances where the G2 encounters repeated wide variations in operating &/or storage temperature, it may be necessary to re-calibrate the tilt sensor.

The tilt measurements from the sensor may also be useful directly, in some applications of the G2, in addition to or instead of the Pitch/Roll data that the G2 computes while doing the RTK.

The GPS Technical Reference manual describes the commands and methodology required to query the tilt sensor, to recalibrate it, and to enable or disable it.

Gyro-aided RTK

The Vector Pro G2's internal gyro offers several benefits. It will shorten reacquisition times when the G2's heading computation is stopped due to momentary obstruction of GPS satellite signals, by reducing the search volume required for solution of the RTK, after obstruction of the signals ends.

The gyro measures the relative angular change in the heading since the last valid RTK heading was computed; in conjunction with the tilt sensor, it reduces the search volume to a wedge-shaped location within the "tilt sensor ring" on the surface of the search sphere.

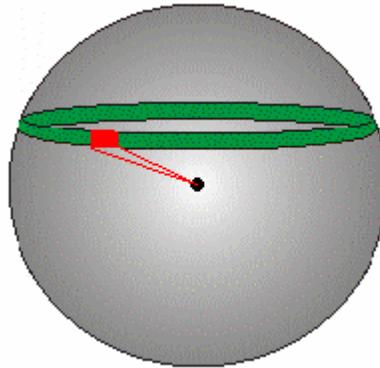

Figure 18 – Tilt & Gyro-aided Search

An additional feature of the gyro is that it can provide an accurate substitute heading for a short period (depending on the Roll and Pitch motions of the vessel), during instances of momentary obstruction of GPS satellite signals at either antenna; this may occur, for example, when passing close to high vertical walls, or underneath bridges.

When such obstructions occur, the gyro is automatically used to provide an alternate source of heading, accurate to within 1°, for up to 3 minutes¹⁰. Ideally, the gyro-based heading will see the system through to reacquisition.

If the outage lasts longer than 3 minutes, the gyro is deemed to have drifted too far and the G2 will begin outputting NULL fields in the heading output sentences, which in turn will typically cause a "lost heading" alarm on navigation devices.

Normal heading output will return automatically once satellite signals are re-acquired.

As well, the gyro helps improve and smooth (filter) the heading and rate of turn data output by the G2; it is used to update the HTAU-smoothed (see page 59) heading output from the RTK computation. This means that if the value of HTAU is increased while the gyro is enabled, there will be little to no lag in heading output due to vessel manoeuvres.

The gyro will initialize itself at power-up and during initialization, or can be calibrated by the user, as outlined the GPS Technical Reference manual.

Caution! *While the gyro is initializing, it is important that the dynamics that the gyro experiences during its warm-up period are similar to the vessel's regular operating dynamics.*

For example, if you will be using the G2 on a high speed, manoeuvrable vessel, it is essential that the vessel is operating in an environment of high dynamic movement – high speed, fast turns, sudden jolts (e.g., over waves), vibration, etc. – for the first 5 to 10 minutes after the G2 is turned on, instead of sitting stationary.

¹⁰ There is no user control over the gyro time-out period.

Normal Operation

Once the Vector Pro G2 has successfully acquired a sufficient number of GPS signals, of high enough quality, it begins to generate navigational data – position, heading, speed and so on.

It's up to you what you do with that data, of course!

The G2 is configured at the factory with a specific set of output data settings ... enabled output data “sentences”, update rates and Baud rates. All those are described in this section.

The suggested standard wiring diagrams (see Figure 12, Figure 14 and Figure 15) are based on that factory-default output configuration. But you may change the G2's configuration as required, and even wire it differently than shown in the standard diagrams.

Output Ports

Typically, the user of a G2 wants it to output certain navigational data, updated at rates that are suitable for the other equipment connected to the G2, and for what the overall “navigation” system is supposed to be doing.

As well, the “bit rate” (i.e., Baud rate) at which the G2's two output ports are transmitting data (& receiving data, if necessary) must match the device(s) to which each is connected.

The G2's two output ports – Port A and Port B – allow for two different sets of navigation data to be output from the G2. Each port can be configured with its own combination of enabled output data sentences, sentence update rates, and Baud rate.

For example: when a SI-TEX autopilot is being used with the G2, heading and speed from the G2 are needed by the autopilot, in order for it to be able to steer the vessel safely on the course that the user wants to follow.

- All SI-TEX autopilots need heading to be updated at a rate of about 10 Hz or more; any slower causes the autopilot's steering control algorithm to respond too slowly to changes in the vessel's actual heading (from wind, waves, current, etc.).
- Speed is only needed at 1 Hz (or less), since it is not used in the steering algorithm, but only to select which set of steering parameters is being used by the autopilot.
- Baud rate is always 4800.

When used with other types of equipment – e.g., a Chartplotter, a Navigation program on a PC, a Radar set – typically there is other information needed: position, course over ground, time & date, the GPS satellites' status and so on. Update rates required are usually slow – 1 Hz or less.

As mentioned previously, the G2 is configured at the factory for easy use in typical marine situations, such as illustrated in Figure 1.

On Port A is a set of sentences for “general-purpose marine Navigation use”, which collectively provides the following information:

- Position, course & speed over ground, time & date, True & Magnetic heading, rate of turn, and GPS satellite status (all at 1 Hz or less).

On Port B are sentences for “autopilot use”:

- True & Magnetic heading (at 10 Hz), and speed (at 1 Hz).

Both ports are at 4800 Baud.

Output Data Formats

There are three formats that the Vector Pro G2 can output data in: the NMEA 0183 Standard's format, a proprietary format, and a binary format.

For full details on the NMEA sentences, please refer to the NMEA 0183 Standard. For details on the G2's specific capabilities (fields, format, etc.) in the NMEA 0183 sentences, please refer to the GPS Technical Reference.

NMEA 0183 Output

Many of the NMEA 0183 Standard's "navigation & GPS data" sentences are available on the G2.

Of those, the sentences enabled in SI-TEX's factory-default configuration are denoted **like this, with the update rate shown in the corresponding column. Sentences not** enabled in the factory-default configuration are indicated with an X. Maximum output rates are shown in the far right column, for convenience.

To make changes, see pages 51 and 52.

Sentence	Description	Enabled		Max Rate
		Port A	Port B	
GPDTM	Datum Reference	X	X	10
GPGGA	Global Positioning System Fix Data	1	X 10	
GPGLL	Geographic Position (Latitude & Longitude)	1	X 20	
GPGNS	GNSS Fix Data	X	X	10
GPGRS	GNSS Range Residuals	X	X	10
GPGSA	GNSS DOP & Active Satellites	0.2	X 1	
GPGST	GNSS Pseudorange Error Statistics	0.2	X 1	
GPGSV	GNSS Satellites in View	0.2	X 1	
GPHDG	True Heading, Variation & Deviation	1	X 20	
GPHDM	Magnetic Heading ¹	1	10	20
GPHDT	True Heading	1	10	20
GPRMC	Recommended Minimum Specific GNSS Data	0.2	X 10	
GPROT	Rate of Turn	1	X 10	
GPRRE	Range Residual ¹	X X 10		
GPVTG	Course and Speed Over Ground	1	1	10
GPZDA	Time and Date	1	X 10	

Table 6 – Default NMEA Output Sentences Configuration

¹ Not approved by the IEC for Marine use

Note: the NMEA Talker ID for the three heading sentences above may be changed from "GP" to "HE" for HDG, HDT & ROT, and "HC" for HDM. Doing so indicates (per NMEA 0183's syntax rules) that they come from a North-seeking gyro heading sensor. The change can be made with the \$JATT,NMEAHE command (see Table 15 on page 55).

 However, configuring the G2 to use the "HE" & "HC" Talker IDs may not be approved by some Standards organizations!

Proprietary Output

A number of NMEA-like¹¹ proprietary output sentences are available on the Vector Pro G2. Only the HPR sentence is enabled when the G2 is shipped from the factory; it is set to a 1 Hz update rate, on Port A. All the others are disabled, and so are indicated below with an X.

Maximum output rates are shown in the far right column, for convenience.

To make changes, see pages 51 and 52 (and 53, for a G2B).

Sentence	Description	Enabled		Max Rate
		Port A	Port B	
PCSI,CS0	Beacon Status Information (G2B only)	X	X	1
PCSI,CS1	Beacon Status Information (G2B only)	X	X	1
PSAT,GBS	GNSS Satellite Fault Detection	X	X	10
PSAT,HPR	Time, True Heading, and RTK-based Pitch (or Roll)	1	X	10
PSAT,INTLT	Tilt (Pitch and Roll) Sensor's Measurement	X	X	1
RD1	SBAS Diagnostic Information	X	X	1

Table 7 – Default Proprietary Output Sentences Configuration

Note: none of the proprietary sentences are approved by the IEC for marine use.

For full details on the G2's proprietary sentences, please refer to the GPS Technical Reference.

Binary Output Sentences

The G2 can be configured to output certain data in sentences that are in a binary format (in contrast to the human-readable ASCII format of the G2's NMEA & Proprietary output sentences).

None of the binary sentences are enabled in the G2's factory-default configuration settings.

To make changes, see pages 51 and 53.

Note: none of the binary sentences are approved by the IEC for marine use.

Caution! Binary sentences may be incompatible with some NMEA equipment, and/or with PCs and other non-NMEA equipment. The incompatibility may be such as to cause a PC &/or other equipment to lock up. Use them with care!

For full details on the G2's binary sentences, please refer to the GPS Technical Reference.

¹¹ ... "NMEA-like" because these sentences follow the general syntax rules of NMEA 0183, although they are not part of that standard, but rather have been defined by Hemisphere GPS. These sentences are available only on their own GPS products, and equipment based on those – such as the Vector Pro G2.

Baud Rate

All SI-TEX autopilots (and all marine equipment which is compliant to the NMEA 0183 Standard) communicate at 4800 Baud, for both input & output.¹²

But, although the NMEA Standard specifies 4800 Baud¹³, it is common for “NMEA compatible” equipment to be able to work at higher speeds (especially at RS-232 levels).

Each of the Vector Pro G2’s two output ports can be configured, independent of each other, to communicate at all conventional Baud rates from 4800 up to 38400 Baud.

The factory-default configuration of both Ports A & B is 4800 Baud.

Note: for operation with all SI-TEX autopilots, the G2’s factory-default Baud rate of 4800 must be used. For operation with other equipment, other Baud rates may be allowable, depending on the equipment.

Electrical Interface

Another factor in using the G2 is what type of the electrical interface (i.e., signal levels, rise/fall times, circuit impedances) the other equipment uses for its Input/Output “navigation data” connections.

All marine equipment which is fully compliant with the NMEA 0183 Standard (e.g., SI-TEX autopilots) uses RS-422 levels only.

Other on-board “NMEA compatible” equipment – e.g., PCs – often uses RS-232 levels.

Each of the G2’s two output ports is available at both RS-232 & RS-422 electrical levels; the RS-232 and RS-422 output signals may be used simultaneously (see Serial Ports on page 28 for more details).

Note: on each port, the sentences that the port is configured to output, their update rates, and the port’s Baud rate, will be the same, for both the RS-232 and RS-422 signals from that port.

Alarm Output

In addition to the data output on the G2’s two serial ports, there is a separate Alarm output, which indicates whether or not the G2 is providing valid heading output data.

An Alarm relay is located on the G2’s circuit board. The relay’s contacts are isolated from all circuitry in the G2 – the G2’s internal processor controls the coil side of the relay, but the contacts of the relay are connected only to the two Alarm pins on the G2’s I/O connector.

If the G2 is unpowered, or if it is powered but is not able to compute valid heading data (for example, when it does not have good GPS signals at one of the two antennae), the relay coil is de-powered. This causes the relay contacts to open – which can then activate whatever system you wish to use to indicate a Loss-of-Heading condition.

When the G2 is powered, and when its heading output data is valid, the relay coil is powered by the G2’s processor, which closes the relay contacts; this indicates that the G2 is operating correctly.

Watchdog

A watchdog timer is controlled by software in the G2, and is triggered when heading becomes invalid for any reason. If the heading remains invalid for a long enough time, the watchdog timer causes the Alarm relay’s contacts to open.

The watchdog software is in compliance with IEC 60495.

¹² The SI-TEX SP36 and the Admiral P3 can optionally work at Baud rates up to 9600 Baud on their NAV2 Inputs, but only with certain equipment (in particular, only with the first generation of the G2, see page 89).

¹³ A supplemental standard, NMEA 0183-HS specifies operation at 38,400 Baud.

Changing the Configuration

You may change the factory-default configuration of the Vector Pro G2, if you wish!

Many other output sentences can be enabled, and/or the factory-default ones disabled, to suit the requirements of any specific installation.

The output update rate of each enabled sentence may be changed as required.

- If a given sentence is enabled on both ports, the output rate on each port may be the same, or different, if desired.

The port Baud rates can be changed, as required.

- There may be different Baud rates on each port, if desired.

These changes, as well as numerous other characteristics of the G2's operation, are done by means of a set of input commands, in "sentences" that are similar to NMEA sentences. These "command sentences" must be sent to the G2 from a suitable "control" device, such as the Navigator G2 GPS Compass Display System, or a PC, via the Receive wire on the RS-232 side of the Primary Port A.

For an overview of how to configure the G2's output sentences, and tables of the G2's available command sentences, see pages 51 through 56.

For a full description and explanation of all the G2's command sentences, please refer to the GPS Technical Reference manual.

Making Changes

To make changes, a suitable control device must be connected to the G2:

- a PC running suitable software – i.e., HyperTerminal or some other "dumb terminal" program, or Hemisphere GPS' PocketMAX PC program.
- a SI-TEX Navigator G2 GPS Compass Display

Using HyperTerminal

HyperTerminal is available for free on all Windows PCs¹⁴. It is an easy means to monitor the Vector Pro G2's operation and status.

But it is quite a bit harder to use it to control & configure the G2 ...

The main problem is that the G2 is constantly sending Navigation data (as it's supposed to do!), which is displayed on HyperTerminal's active display "screen" – as it arrives, character by character and line by line, scrolling up in (& eventually off) the display.

The result that it's hard to "look" at any one item, or to see or edit – while you type them in – the commands you're trying to send to the G2, or to see the G2's responses to those commands. Everything gets lost in the "clutter" of the continuously-arriving data.

But, despite these problems, HyperTerminal is still useful – and sometimes it's the only readily available means available to monitor & control the G2.

If your PC has two COM ports, you can even run two instances of HyperTerminal simultaneously, and thus monitor all output from the G2's two serial ports.

Instructions on setting up HyperTerminal for use with a G2, and some examples of typical use, are given in Appendix 2.

The system must be wired as shown in Figure 14 or Figure 15. The G2's Port A should be connected to the PC's first COM port; if you want to monitor both of the G2's ports, Port B should be connected to the PC's second COM port.

¹⁴ There are many similar freeware, shareware & commercial programs available for Windows PCs, and for Apple® Macs®. None are discussed here, but all will have similar characteristics (and things to watch out for!) to HyperTerminal.

Using PocketMAX PC

Full instructions are in the PocketMAX User Manual.

The system must be wired as shown in Figure 14 or Figure 15.

Note: PocketMAX PC may not always run properly on some PCs. It has been known to hang up, and/or crash the PC (especially on an older, slower PC), and/or leave the G2 in an invalid state.

SI-TEX recommends that you use PocketMAX only on a fairly new PC, with a fast CPU, lots of RAM, and “standard” COM ports.

Caution! Please pay attention to the “... doing many things ...” warning in the first section of the PocketMAX manual!

Also, please note that PocketMAX was designed to support all of Hemisphere GPS’ products – and so some of its features do not apply to the G2¹⁵.

Some points to be aware of, if you wish to use PocketMAX:

It does not “know” about a few sentences that the G2 supports (e.g., the \$GPHDM sentence¹⁶); thus, it is not possible to control those sentences with PocketMAX.

It does not know the full range of Update rates that a few sentences can be set to (e.g., \$GPGSA & \$GPGSV can be set to 0.2 Hz).

Each time you start it, you must select “Hemisphere Vector Pro” as the type of Receiver in use, in the drop-down selector box on the program’s start-up screen; that is the closest type of Receiver to a G2 that PocketMAX can be set for:

Using a Navigator G2

The Navigator G2 GPS Compass Display System is the easiest & best way to monitor and control a G2.

Full instructions are in the Navigator G2 Installation & Operation Manual.

The system must be wired as shown in Figure 12, and in the Navigator manual.

¹⁵ Updated versions of PocketMAX may be released in future; please check on Hemisphere GPS’s web site. The current version when this manual was being written was 2.2.0.

¹⁶ HDM & the other “unknown” sentences/parameters were part of the customizations added in SI-TEX’s variant of the Hemisphere Crescent product, but they were added after PocketMAX was designed.

Configuration Commands

The NMEA-like input sentences in the following tables are commands that can be used to configure the Vector Pro G2.

These commands must be sent to the G2 on the RS-232 Receive signal wire of Port A. *All commands must end with an END OF LINE sequence (i.e., ASCII <CR><LF> codes).* Most commands may be entered in upper, lower or mixed case.

Some of the commands have optional parameters (shown in square brackets in the tables). The optional parameters, if used, should be entered with the comma shown below, but without the square brackets.

In many cases, it is possible to query the current value, or status, of one of the G2's operating parameters or sensors, by sending the associated command without a value for the parameter (e.g., send \$JATT,HBIAS to query the Heading Bias value).

Some of these commands enable or disable the G2's NMEA, Proprietary and Binary output sentences. The G2 responds by beginning to output the specified sentence at the specified update rate on the specified port (or by ceasing to output the sentence, if you specify that).

- When an output sentence can be set to different update rates, the range of valid update rates is shown in parentheses in the Description column. A rate of "0" disables output of a sentence. All rates are in Hz.
- For output sentences which can only be enabled or disabled, the control parameter is either "0/1" (where 0 disables output of the sentence, and 1 enables it), or the specific words (e.g., "NO/YES") to be used.
- For commands that control sentences that can be output on either of the G2's ports, the command affects the output of Port A¹⁷, unless the optional final parameter OTHER is added, which causes the command to be applied to Port B.
- The units of the various "value" parameters depend on the affected function or setting in the G2 (e.g., rates in Hz, time in seconds, angles in degrees, and so on). All the units are implicit, and are not required in the command.

Other commands control some aspect of the G2's operation – for example, the Baud rate that the specified port will run at. The G2 responds by making the specified change, and (in most cases) outputs a reply (e.g., "\$>Jaaa,OK").

Other commands request some specific information from the G2. The G2 responds with that information – but it only does so one time ... i.e., the reply does not "update" on a repeated basis, unlike the NMEA & other outputs.

To help you understand these commands, a number of examples of their usage can be found on pages 81 to 84.

 *All changes that you make are "temporary", unless you send a \$JSAVE command to the G2. If you power-cycle the G2 before doing that, all your changes will be lost, and the G2 will power-up with the configuration that was last Saved.*

On the other hand, if you do send a \$JSAVE while the G2 has some changes in settings that you meant to be "temporary" (for example, shutting off all normal data output, so you can query & inspect status more easily), then those changed settings will be the "permanent" power-up settings (until you change things again, and do another \$JSAVE).

 **Caution! You MUST wait until the G2 responds with a "SAVE OK" reply, after sending a \$JSAVE, before you power-down the G2.**

¹⁷ ... unless you are sending the command on Port B's Rx wire, in which case the "OTHER" parameter means "Port A". To avoid confusion, SI-TEX recommends that all command input to the G2 be done on Port A.

Caution

Many of the commands in the tables below will affect the performance of the Vector Pro G2. Improper settings may result in degradation of system output, which can affect the overall safety of the vessel and personnel.

Command	Sentence	Rate (Hz)
\$JASC,GPDTM,rate[,OTHER]	GPDTM	0, 0.2, 1, 5 or 10
\$JASC,GPGGA,rate[,OTHER]	GPGGA	0, 0.2, 1, 5 or 10
\$JASC,GPGLL,rate[,OTHER]	GPGLL	0, 0.2, 1, 5, 10 or 20
\$JASC,GPGNS,rate[,OTHER]	GPGNS	0, 0.2, 1, 5 or 10
\$JASC,GPGRS,rate[,OTHER]	GPGRS	0, 0.2, 1, 5 or 10
\$JASC,GPGSA,rate[,OTHER]	GPGSA	0, 0.2, 1, 5 or 10
\$JASC,GPGST,rate[,OTHER]	GPGST	0, 0.2, 1, 5 or 10
\$JASC,GPGSV,rate[,OTHER]	GPGSV	0, 0.2, 1, 5 or 10
\$JASC,GPHDG,rate[,OTHER]	GPHDG	0, 0.2, 1, 5, 10 or 20
\$JASC,GPHDM,rate[,OTHER]	GPHDM 1	0, 0.2, 1, 5, 10 or 20
\$JASC,GPHDT,rate[,OTHER]	GPHDT	0, 0.2, 1, 5, 10 or 20
\$JASC,GPRMC,rate[,OTHER]	GPRMC	0, 0.2, 1, 5 or 10
\$JASC,GPROT,rate[,OTHER]	GPROT	0, 0.2, 1, 5 or 10
\$JASC,GPRRE,rate[,OTHER]	GPRRE 1	0, 0.2, 1, 5 or 10
\$JASC,GPVTG,rate[,OTHER]	GPVTG	0, 0.2, 1, 5 or 10
\$JASC,GPZDA,rate[,OTHER]	GPZDA	0, 0.2, 1, 5 or 10

Table 8 – Commands for the NMEA Output Sentences

1 Not approved by the IEC for Marine use

Command Sentence	Rate (Hz)	
\$JASC,D1,rate[,OTHER]	RD1	0 or 1
\$JASC,GPGBS,rate[,OTHER]	PSAT,GBS	0, 0.2, 1, 5 or 10
\$JASC,HPR,rate[,OTHER]	PSAT,HPR	0, 0.2, 1, 5 or 10
\$JASC,INTLT,rate[,OTHER]	PSAT,INTLT	0 or 1
\$JASC,RTCM,rate[,OTHER]	1	0 or 1

Table 9 – Commands for the Proprietary Output Sentences

1 The RTCM output “sentence” is all binary data, and so should be used with care! RTCM data is only available when the G2 is configured to use SBAS correction data (see the \$JDIF command in Table 15).

The RTCM output sentence can only be turned off with a \$JASC,RTCM,0[,OTHER] command.

Command	Data in Sentence	Rate (Hz)
\$JBIN,1,rate	GPS Position	0, 0.2, 1 or 5
\$JBIN,2,rate	GPS & SBAS Satellites used, Time, DOPs	0 or 1
\$JBIN,80,rate	GPS SBAS information	0 or 1
\$JBIN,94,rate	Ionosphere & UTC conversion parameters	0 or 1
\$JBIN,95,rate	GPS Ephemeris information	0 or 1
\$JBIN,96,rate	Code & carrier phase information	0 or 1
\$JBIN,97,rate	Processing statistics	0 or 1
\$JBIN,98,rate	GPS Satellite & Almanac information	0 or 1
\$JBIN,99,rate	GPS diagnostic information	0 or 1

Table 10 – Commands for the Binary Output Sentences

 *The Binary output sentences should only be enabled by a program or control device which properly understands them (such as the Navigator G2). They should not be enabled when using HyperTerminal, since they are not human-readable – and worse, they can sometimes cause HT to crash.*

Note: See the GPS Technical Reference for full details on the Binary sentences.

Command	Sentence	Rate (Hz)
\$PCSI,1,rate	PCSI,CS0	0 or 1
\$PCSI,2,rate	PCSI,CS1	0 or 1

Table 11 – Commands for the Beacon Output Sentences (G2B only)

 *The PCSI Beacon sentences can only be turned off with a \$PCSI,1,0 and/or \$PCSI,2,0 command.*

 *The PCSI commands must be entered in UPPER case.*

Command	Description
\$GPCRQ,MSK	Query the Beacon receiver's operational status
\$GPCRQ,MSS	Query the Beacon receiver's performance status
\$GPMSK,	parameters Tune the Beacon receiver

Table 12 – Commands for the Beacon Receiver (G2B only)

Note: See the GPS Technical Reference for full details on all the Beacon commands.

Command	Action & Time Constant Affected	Range (seconds)
\$JATT,COGTAU,cogtau	Query or Set the Course-Over-Ground Constant	cogtau = 0.0 to 200.0
\$JTAU,COG,cogtau		
\$JATT,HTAU.htau	Query or Set the Heading Constant	htau = 0.0 to 3600.0
\$JATT,HRTAU,hrtau	Query or Set the Rate of Turn Constant	hrtau = 0.0 to 3600.0
\$JATT,PTAU,ptau	Query or Set the Pitch (or Roll) Constant	ptau = 0.0 to 3600.0
\$JATT,SPDTAU,spdtau	Query or Set the Speed Constant	spdtau = 0.0 to 200.0
\$JTAU,SPEED,spdtau		
\$JSMOOTH,time	Query or Set the Carrier Smoothing Time	time = SHORT ® 300 time = LONG ® 900 time = 15 to 6000

Table 13 – Commands for the Smoothing Time Constants

Note: see Smoothing Output Data with Time Constants on page 59 for full details of the TAU time constants.

Command	Description
\$JATT,GYROAID[,NO/YES]	Query or Enable/Disable the Gyro-aiding feature
\$JATT,HBIAS[,hbias]	Query or Set Heading Output Offset hbias range is -180° to +180°
\$JATT,LEVEL[,NO/YES]	Query or Set Level Mode Operation YES ® Tilt less than 10°
\$JATT,NEGTILT[,NO/YES]	Query or Set the Pitch/Roll sign convention NO ® normal YES ® reverse sign
\$JATT,PBIAS[,pbias]	Query or Set the Pitch/Roll Output Offset pbias range is -15° to +15°
\$JATT,ROLL[,NO/YES]	Query or Set the Pitch/Roll Orientation NO ® Pitch YES ® Roll
\$JATT,T25CAL[,NO/YES] Query or	Enable/Disable the xxxxx
\$JATT,TILTAID[,NO/YES] Query or	Enable/Disable the Tilt Sensor
\$JATT,TILTCAL	Calibrate the Tilt Sensor <i>(the G2 must be level when this command is issued)</i>
\$JBAUD,rate[,OTHER]	Query or Set the Baud rate rate = 4800, 9600, 19200, 38400 <i>(if you change the G2's Baud rate, you must change the other device(s) to match!)</i>

Table 14 – Commands for Baud Rates, Installation Options & Internal Sensors

- 1 In most cases where the command option is NO or YES, 0 or 1 can be used instead:
0 ® OFF, 1 ® ON.

Command	Description
\$J4STRING,BAUD[,OTHER]	Enable GPGGA, GPGSA, GPVTG & GPZDA at 1 Hz Set both ports Baud rate to BAUD (4800, 9600, 19200, 38400) Do a \$JSAVE (see Table 16) 
\$JAGE,age	Set the Differential Age Timeout age = 6 to 8100 seconds
\$JATT,COAST[,NO/YES] 1	Query or Enable/Disable the xxxxx
\$JATT,COGAID[,NO/YES]	Query or Enable/Disable the xxxxx
\$JATT,EXACT[,NO/YES]	Query or Enable/Disable the xxxxx
\$JATT,HDMTRUE[,NO/YES]	Query or Set whether the Heading value in GPHDM is in degrees True or degrees Magnetic NO ® Magnetic, YES ® True
\$JATT,HIGHMP[,NO/YES]	Query or Enable/Disable the xxxxx
\$JATT,NMEAHE[,NO/YES]	Query or Set the Talker ID for heading sentences: NO ® all sentences use GP YES ® HEHDG, HCHDM, HEHDT, HEROT
\$JATT,STOPPED[,NO/YES]	Query or Enable/Disable the xxxxx
\$JDIFF[,source]	Query or Set the DGPS source: NONE ® Operate in autonomous mode WAAS ® SBAS corrections OTHER ® RTCM SC-104 corrections input through Port B BEACON ® Radiobeacon corrections (G2B only)
\$JMASK,angle	Set a cut-off elevation, below which satellites will be ignored Angle range is 0° to 60°
\$JNP[,digits]	Query or set the number digits after the decimal point in the GPGGA & GPGLL output sentences digits = 1 to 8
\$JOFF[,OTHER]	Turn off all NMEA & Proprietary data output  The PCSI Beacon status sentences must be turned off with a \$PCSI,0,0 and/or \$PCSI,1,0 command  The RTCM output sentence must be turned off with a \$JASC,RTCM,0[,OTHER] command
\$JPOS[,latitude,longitude]	Query or set an initial position, to speed up re-acquisition time Latitude & Longitude must be in decimal degrees example: \$JPOS,49.2,123.1

Table 15 – Commands for Miscellaneous Features & Functions

1 In most cases where the command option is NO or YES, 0 or 1 can be used instead:
0 ® OFF, 1 ® ON.

 **Caution! The automatic \$JSAVE done by the \$J4STRING command will any include any other changes you may have made before sending the command.**

Command	Description
\$JATT,CSEP	Query the current computed antenna separation (Should always return 0.500 ± 0.010 metres)
\$JATT,MSEP[,sep]	Query or Set the actual separation between the antennae ⚠ <i>In the Vector Pro G2 & G2B, the physical antenna separation is fixed at 0.5 metres – so this command should only be used to check that the MSEP value is set correctly (to 0.5)!</i>
\$JATT,HELP	Show a list of the various JATT commands which are available
\$JATT,SEARCH	Force a new RTK Search
\$JATT,SUMMARY	Query current settings of several parameters
\$JGEO	Query the frequencies and locations of SBAS satellites being used
\$JI	Query the G2's serial number and firmware versions
\$JT	Query the receiver type
\$JQUERY,GUIDE	Query whether the G2 is providing suitable performance or not
\$JRESET ⚠	Reset to default settings ⚠ DO NOT USE
\$JSAVE	Save current operating configuration
\$JSHOW[,BIN/CONF/GP]	Show current operating configuration empty ® show everything BIN ® show Binary sentences CONF® show modes & limits GP® show NMEA & Proprietary sentences
\$JWAASPRN	Query the PRNs of the SBAS satellites currently being used

Table 16 – Commands for Status & Configuration

⚠ *The \$JRESET command should NEVER be used!!*

It does not reset the G2's configuration to the SI-TEX factory defaults, as you might expect, but instead to Hemisphere GPS's own factory defaults, which are quite different (including the Baud rates being 19200).

If you happen to send this command by accident, please call your SI-TEX Dealer for assistance in restoring normal operation of your G2.

Other Commands

The commands in Table 8 through Table 16 above are all the ones typically used in marine applications of the G2.

There are several other commands which Hemisphere's Crescent chipset supports.

Most of these other commands are documented in the GPS Technical Reference .¹⁸

However, it should be noted that the GPS Technical Reference is a general-purpose reference for the Crescent chipset, & products based on that – but SI-TEX's Vector Pro G2 & G2B products do not implement all of the chipset's features. So, the information in that document must be used with some caution, when used with the G2.

Some of these other commands can be used for special applications, diagnostics, or other purposes. Describing them and their use is beyond the scope of this manual.

Some of the rest simply make no sense in the G2. The chipset provides them (& reacts to them) for when it used in discrete-antennae GPS Compass products (such as the Hemisphere Sensors, or SI-TEX's Navigator G4), in custom circuit designs, or in OEM products built around Hemisphere's GPS Receiver "module".

The remainder of the other commands are for features and functions not supported in SI-TEX's versions of the Hemisphere products.

Some specific items you should ignore are:

all "subscription", e-Dif, L-Dif & OmniSTAR features, and related commands
anything related to Ports C & D

the \$JALT, \$JAPP, \$JCONN, \$JK, \$JLIMIT and \$JWCONF commands

the \$JATT,FLIPBRD command

any commands relating to Binary outputs Bin 76 & 93

Some newer ones are not mentioned, and there are also some formatting errors in the document.

¹⁸

Customising & Fine-tuning the Configuration

There are a number of situations where you might want to change the Vector Pro G2's factory-default configuration settings in ways other than simply enabling or disabling the specific sentences that your system requires, or changing the update rates of the enabled sentence(s).

Roll Alignment

One common situation is if you have mounted the G2 athwartships.

In this case, you must tell the G2 that it is mounted that way, by sending it the following commands:

\$JATT,ROLL,YES

and

\$JATT,HBIAS,90.0 (if you have mounted the G2 pointing to Port)

or

\$JATT,HBIAS,-90.0 (if you have mounted the G2 pointing to Starboard)

The ROLL command tells the G2 that it is pointing athwartships, so that it will output its RTK-based "pitch/roll" measurement in the "roll" field of the \$PSAT,HPR output sentence.

The HBIAS command (you would send only one of the ones above) tells the G2 which side of the vessel it is pointing to. When it is pointing to Port (see Figure 3), the G2 must add 90° to its RTK heading computations, in order to get the vessel's correct heading; alternatively, when pointing to Starboard 90° must be subtracted from the computed heading.

Note: the HBIAS command does not affect the RTK-based "pitch/roll" computation (for the HPR sentence), nor the actual tilt measurement by the tilt sensor (in the INTLT sentence). These values are always based on the tilt angle between the Primary & Secondary antennae.

In order to tell the G2 that you have mounted it pointing at the bow:

\$JATT,ROLL,NO

\$JATT,HBIAS,0

Note: this is the factory-default. You would only need to send these commands to the G2 if you have been using an athwartships mounting, and then have re-mounted the G2 in a "parallel to centreline" orientation.

Biased Alignment(s)

If there is some bias in the alignment of the G2's enclosure, you will need to tell the G2 what that is. Some examples:

If the enclosure is mounted pointed at the bow, but at a slight angle (say, 5.5° to Port): \$JATT,HBIAS,5.5.

– For 5.5° to Starboard: \$JATT,HBIAS,-5.5.

If the enclosure is mounted athwartships, but at an angle slightly less than abeam (say, 81.0° to Port): \$JATT,HBIAS,81.0.

– If pointed 81.0° to Starboard: \$JATT,HBIAS,-81.0.

If the enclosure is mounted with a slight tilt (say, 7.5°) from the Primary antenna to the Secondary antenna: \$JATT,PBIAS,-7.5.

– If the tilt is from the Secondary to the Primary antenna: \$JATT,PBIAS,7.5.

Note: the PBIAS command only affects the RTK-based "pitch/roll" computation (for the HPR sentence), not the actual tilt measurement by the tilt sensor (in the INTLT sentence).

Disabling the Tilt Sensor

The Vector Pro G2's tilt sensor is enabled by default.

You can turn the tilt sensor off with a `$JATT,TILTAID,0` command.

The only time you might need to do that is when troubleshooting, to ensure the GPS receiver is working properly.

Re-calibrating the Tilt Sensor

The tilt sensor is pre-calibrated at the factory.

However, if you experience any large amount of tilt measurement error (more than about 6° from actual tilt angle), you can recalibrate the sensor, by using the `$JATT,TILTCAL` command. To do this: power off the G2, shield it from all satellite signals, check that it is as level as possible, power it back on, and then issue the recalibration command.

You can observe the actual tilt measurements from the sensor by sending the `$JASC,INTLT,rate[OTHER]` command to the G2.

Disabling the Gyro Sensor

The G2's internal gyro sensor is enabled by default.

The only time you might need to disable the gyro is when troubleshooting, to ensure GPS the receiver is working properly.

You can turn the gyro off by sending a `$JATT,GYROAID,0` command.

Smoothing Output Data with Time Constants

The G2 incorporates user-configurable time constants which can provide a degree of smoothing to the course over ground, heading, pitch, rate of turn, and speed outputs.

Each time constant – called “something” TAU – is a value that sets the length of a simple averaging filter for that specific output. For example, the default value of HTAU tells the G2 to smooth heading outputs with a filter that is 2.0 seconds in length.

Table 17 (on the next page) describes all the time constants.

Changing the Time Constants

The G2's default time constant settings are fine for most users.

But you can set the time constants to be a better match to the dynamics of your vessel, if you like.

For instance, if the vessel is very large and is not able to turn quickly, increasing the heading time constant (HTAU) might be useful. The resulting heading values would have less apparent jitter¹⁹ and be more consistent – both from moment to moment and over longer periods of time as the vessel moves – with the vessel's “real” heading.

On the other hand, increasing a time constant also increases the G2's time lag in responding to actual changes in the value being measured – i.e., it takes longer for a “real change” in the value being measured to show up in the G2's output data.

Worse, increasing a time constant too far could create an unacceptable lag in the measurement – to the point where the navigation equipment that is receiving data from the G2 would begin to be adversely affected.

- For example, an autopilot will begin to appear sluggish in its steering performance, if the heading time constant is increased too far. That's because the time lag on heading will become so large that the autopilot can not “see” small changes in heading quickly (or perhaps even not at all).

¹⁹ There will always be some residual jitter in computed-heading data, even with the G2's sophisticated RTK algorithms. It's an unavoidable effect of the physics & underlying mathematics of the overall GPS system.

Measurement	Time Constant	Sentences Affected	Usage
Course Over Ground	COGTAU	\$GPVTG	If the vessel is resistant to quick changes in its motion, increase it.
Heading	HTAU	\$GPHDT, HDG, HDM	If vessel does not turn quickly, increase it.
Rate Of Turn	HRTAU	\$GPROT	If vessel does not turn quickly, increase it.
Pitch (or Roll)	PTAU	\$PSAT,HPR	If vessel does not pitch (roll) quickly, increase it.
Speed	SPDTAU	\$GPRMC, VTG, BIN 1	If the vessel does not change speed quickly, increase it.

Table 17 – Smoothing Time Constants

If your vessel is small and highly manoeuvrable, or if you are unsure of how changing these values will affect your vessel (and the other navigation equipment you have on-board), it is probably best to be conservative and leave the time constants at the default settings.

But, if you do wish to change any of the G2's time constants, the next table provides some formulae for figuring out an optimal value of each constant.

For further details, please consult the GPS Technical Reference manual.

Time Constant	Range (seconds)	Formula 1
COGTAU	0.0 to 60 default: 0.0	$\frac{\text{max rate of change of course (in }^\circ\text{/sec)}}{10}$
HTAU	0.0 to 60.0 default: 2.0	gyro ON: $\frac{40}{\text{max rate of turn (in }^\circ\text{/sec)}}$ gyro OFF: $\frac{20}{\text{max rate of turn (in }^\circ\text{/sec)}}$
HRTAU	0.0 to 60 sec default: 2.0	$\frac{\text{max rate of rate of turn (in }^\circ\text{/sec}^2\text{)}}{10}$
PTAU	0.0 to 60 sec default: 0.5	$\frac{10}{\text{max rate of pitch (in }^\circ\text{/sec)}}$
SPDTAU	0.0 to 60 sec default: 0.0	$\frac{\text{max rate of Acceleration (in metres/sec}^2\text{)}}{10}$

Table 18 – Time Constant Formulae

1 Speed conversions: 1 Knot = 0.51444 metres/sec & 1 Km/H = 0.53996 Knots

Note: the default value of 2.0 seconds for HTAU & HRTAU is correct when the gyro is enabled. If the gyro is disabled, the equivalent default value of HTAU is 0.5 seconds. But the HTAU constant is not automatically changed if the gyro is disabled, and therefore must be changed manually.

 **CAUTION! COG is computed using the Primary GPS receiver only, and its accuracy is dependant upon the speed of the vessel (noise in the COG measurement is inversely proportional to speed).**

 **When the vessel is stationary, the value of COG is invalid!!**

DGPS Source

The factory-default DGPS correction source in the Vector Pro G2 is NONE; the default source in the G2B is BEACON. This may be changed using the \$JDIF command (see Table 15 on page 55).

To select SBAS signals for the DGPS data, use a \$JDIF,WAAS command.

However, this should only be done in areas where the visible SBAS satellites are sending data that is valid for the area where the G2 or G2B is currently located.

For example, the “WAAS” correction data is provided by the FAA in the U.S., so it is thus only officially valid for the continental U.S., Alaska, Hawaii & Puerto Rico. Unofficially, it is valid for much of southern Canada (in a strip along the 49th Parallel), and northern Mexico.

See the GPS Technical Reference manual for a more detailed description of the capabilities and limitations of the SBAS technology.

Note: although the parameter in the \$JDIF command which enables the G2 to use SBAS DGPS corrections is the word “WAAS”, that word in fact tells the G2 to use whatever valid source of SBAS signals is visible in the geographic location the G2 is currently at. Thus, in Europe, “WAAS” means “use EGNOS” – and similarly in other regions which may have SBAS service.

The Beacon receiver in the G2B is always running, no matter which DGPS mode is in use. The receiver is by default running in full-automatic tuning mode; it may be changed to manual tuning, using the GPMSK command (see the GPS Technical Reference).

If neither SBAS nor Beacon corrections are available, an external source of RTC SC-104 differential corrections may be selected (\$JDIF,OTHER).

Baud Rates & Data Bandwidth

If you are going to change the enabled sentences and/or update rates that the G2 is outputting (on one or both ports), you may need to change the Baud rate, with the JBAUD command²⁰.

The factory-default Baud rate for both Ports A & B in the G2 is 4800 Baud; this complies with the NMEA 0183 Standard. The G2’s serial data is always formatted 8-N-1, which means that there are 10 bits sent per byte, and so the factory-default transmit/receive data bandwidth is 480 bytes/second, on each port.

In any serial communications system, the total number of bytes sent per second must not exceed the data bandwidth. A good rule of thumb when setting up serial communications systems is that the total bytes/sec should be less than ~90% of the bandwidth:

The NMEA & proprietary sentences enabled in the factory defaults fit within the data bandwidth of the factory-default 4800 Baud: 417.4 bytes/sec on Port A, and 445 bytes/sec on Port B.

If the Baud rate is too low – i.e., bandwidth less than the total bytes/sec that the G2 is configured to transmit – the data will be corrupted, in random & unpredictable ways. The result will typically be “Invalid Data” errors on the equipment that is connected to the G2.

On the next page is a screen shot of a “bandwidth estimation” calculation (a simple MS Excel → worksheet) for the G2. In your own calculations, you should use the lengths of the data in the example sentences of the screen shot, to check that any changes you wish to make do not exceed the bandwidth at the Baud rate(s) the G2 is configured to. If they do, you will have to change the G2’s Baud rate accordingly, or else set up a different, lower-bandwidth, combination of enabled sentences & update rates.

²⁰ If you change Port A’s rate using HyperTerminal or PocketMAX, you will have to change their Baud rates too, right after the G2’s rate is changed. The Navigator G2 automatically detects the G2’s Baud rate, in contrast.

Microsoft Excel - NMEA Sentence Totals Estimator (Vector G2).xls

Type a question for help

Vector G2, G2B Output Sentences
(typical examples of the ones that can be set to repeat, recorded at ComNav on a G2B, 14 May 2009, ~1430 PDT)

	A	B	C	D	E	F	G	H	I	J	K
			Sentence Length #	Max Rate !!	Default Rate	Port A Rate in Use	Total/sec		Default Rate	Port B Rate in Use	Total/sec
1											
2			49	10	0	0	0		0	0	0
3			80	10	1	1	80		0	0	0
4			52	10	1	1	52		1	0	0
5			76	10	0	0	0		0	0	0
6			51	10	0	0	0		0	0	0
7		*	49	1	0.2	0.2	9.8		0	0	0
8			51	1	0.2	0.2	10.2		0	0	0
9		*	64	1	0.2	0.2	12.8		0	0	0
10		*	68	1	0.2	0.2	13.6		0	0	0
11		*	64	1	0.2	0.2	12.8		0	0	0
12		*	33	20	1	1	33		0	0	0
13		!!!	20	20	1	1	20		10	10	200
14		!!!	20	20	1	1	20		10	10	200
15		!!!	77	10	0.2	0.2	15.4		0	0	0
16		!!!	18	10	1	1	18		0	0	0
17		!!!	78	10	0	0	0		0	0	0
18			45	10	1	1	45		1	1	45
19			38	10	1	1	38		0	0	0
20			67	1	0	0	0		0	0	0
21			61	1	0	0	0		0	0	0
22			64	10	0	0	0		0	0	0
23			39	10	1	1	39		0	0	0
24			24	1	0	0	0		0	0	0
25			60	1	0	0	0		0	0	0
26			1248				419.6				445
27							net totals/sec:				
28							4800				4800
29											92.7%
30			Percent of bandwidth at Baud rate:								
31			Total bytes/sec if all sentences above were enabled (each at a 1 Hz update rate):								
32			# sentence length is number of characters in the example sentence (plus 2 for the terminating CRLF)								
33			* several sentences, especially GSA & GSV, might be longer (depends on signal reception conditions, Heading, Speed, etc.)								
34			! there are normally 3 GSV sentences, in the sequence shown, so all must have the same rate								
35			!! rates can be 0.2, 1, 2, 5, 10 or 20 Hz - max depends on sentence (0 = OFF)								
36			!!! HDG, HDT & ROT can optionally have a Talker ID of "HE", and HDM can have "HC"								
37			Examples from other equipment								

Figure 20 – Data Bandwidth Estimation

Care & Maintenance

Care & Maintenance

The Vector Pro G2 & G2B GPS Compasses have been designed to provide many years of reliable service. The following care and maintenance tips will help to ensure the longevity of your Vector Pro.

Protection of Wires and Cabling

After installation, ensure that the system components are securely mounted and will not shake loose due to the vibrations that can be expected in a marine vessel.

Ensure that the cable to the G2 is well secured with clamps or alternative fasteners.

Many potential problems can be avoided by ensuring that cabling and wiring do not cause any strain on the connectors.

Periodic Checks

After the first six months of operation, a thorough examination of the entire G2 system **MUST BE UNDERTAKEN**. Verify that all electrical connections, cables, clamps, mounting brackets, and mechanical connections are secure.

An **ANNUAL** inspection should be undertaken thereafter.

General Precautions

A few precautions will keep the unit in prime condition:

The G2's enclosure does not require any special maintenance. An occasional cleaning is suggested; use a damp cloth and mild soap.

 *Do not use abrasive cleaners or chemicals.*

Avoid exposing the enclosure to solvents, acids, and bases – some of these may weaken the plastic.

The G2's enclosure is designed to be weatherproof and splash resistant, but it should not be immersed in water for a prolonged period of time.

Environments exceeding a maximum temperature of 85°C or below a minimum temperature of -40°C **MUST BE AVOIDED**.

Repair

There are no user-serviceable parts or adjustments inside the G2's enclosure. Should the unit become damaged in any way, return it to an authorized SI-TEX Dealer.

Fuse Replacement

There are no fuses used inside the G2 itself. However, it is strongly recommended that a fuse (or circuit breaker) be installed in the G2's Power wiring (see page 17).

 *If the fuse/breaker blows, determine the cause before replacing/resetting!!*

Appendices

Appendices

Appendix 1

Specifications

GPS Receiver

Parameter	Specification
Receiver Type	Twin receivers, 0.5m antenna separation L1, C/A code, with carrier phase smoothing 1.575 GHz carrier frequency
Channels	Two x 12, parallel tracking (Two x 10 channels when tracking SBAS)
Update Rate	position: adjustable, 20 Hz max heading: adjustable, 20 Hz max
Horizontal Accuracy 1	< 1 m RMS when using DGPS corrections < 2.5 m RMS when autonomous (no SA) Datum: WGS 84
Heading Accuracy 2	< 0.5° RMS (Magnetic Variation computations are based on the World Magnetic Model 2005)
Rate of Turn	90° per second max.
Start Up time	< 60 seconds typical
Heading Fix	< 20 seconds typical
Satellite Reacquisition	< 1 second
Compass Safe Distance	1.25 m (standard magnetic compass) 0.80 m (steering magnetic compass)
Compass Safe Distance (reduced)	0.75 m (standard magnetic compass) 0.50 m (steering magnetic compass)

Table 19 – GPS Receiver Specifications

- 1 Accuracy depends on multipath environment, number of satellites in view and satellite geometry
- 2 The quality of DGPS corrections has no impact on heading performance.

Note: the performance figures above are based on a minimum of four visible satellites, HDOP less than 4, PDOP less than 6, high-quality DGPS corrections and otherwise normal conditions.

 Excessive multipath, GPS signal obstructions and/or interference may reduce the performance.

DGPS Beacon Receiver (G2B only)

Parameter	Specification
Channels	2, parallel tracking
Frequency Range	283.5 to 325.0 KHz 84 channels, automatic or manual selection
Sensitivity	2.5 dB V for 5 dB SNR @ 200 bps
Dynamic Range	100 dB
Adjacent Channel Rejection	61 dB @ ±400 Hz offset
Compliance	IEC 61108-4 Beacon Standard

Table 20 – DGPS Beacon Receiver Specifications

System Interface

Parameter	Specification
Ports	RS-232 Serial: <ul style="list-style-type: none"> ○ 2 full-duplex RS-422 Serial: <ul style="list-style-type: none"> ○ 2 half-duplex, output only ○ same data as output on RS-232 all ports optically isolated
Baud Rate	4800 (default), 9600, 19200 and 38400
Data Output Protocol	NMEA 0183, proprietary ASCII (Crescent) & proprietary binary (see Table 6 & Table 7)
Data Input Protocol	NMEA-like (see Table 8 - Table 10)
Timing Output 1	1 pps, 50 ns accuracy (HCMOS level, active Hi, rising edge)
Heading warning I/O	Open relay system indicates invalid heading

Table 21 – System Interface Specifications

- 1 The 1 PPS Timing output is available on the connector on the G2's enclosure, but is not wired in the third-generation's cables (see Table 26).

Power

Parameter	Specification
Supply Voltage	11 to 36 VDC
Power Consumption	< 4.5 W nominal, 360 mA (max) @ 12 VDC

Table 22 – Power Specifications**Mechanical**

Parameter	Specification
Dimensions	60 cm x 16 cm x 18 cm (23.6 in. x 6.3 in. x 7.1 in.), not including mount
Weight 1.5 Kg	
Enclosure Rating	IP 67
Operating Temperature	-32°C to +74°C
Storage Temperature	-40°C to +85°C
Humidity	0 to 100% condensing
Data cable length	standard: <ul style="list-style-type: none"> ○ 15 metres (50 feet), ○ or 30 metres (100 feet) (custom lengths are available)

Table 23 – Mechanical Specifications

Appendix 2

Setting Up & Using HyperTerminal

This section describes the basic procedures for using HyperTerminal with a Vector Pro G2.

Most of the screen shots and examples of typical data & commands in this section were taken while running the standard HyperTerminal²¹ program on a newer PC (running a Core2 Quad CPU, Windows XP Pro 32-bit SP3, and an LCD display at 1600 x 1200). The PC™ G2 connection (on the G2's RS-232 ports) was via two generic USB-to-Serial adapters set up for COM 5 & 6. The G2B's Port A was connected to COM 5, and Port B to COM 6.

The two detailed ports' examples were taken on an older laptop (Celeron CPU, Windows XP Pro SP3, LCD display 1024 x 768). The G2B's RS-232 ports were connected via a generic 4-serial-input to USB adapter; Port A was mapped to COM4, Ports B to COM5.

Set Up a New Connection

Start Hyperterminal²², and give the new connection a name & Icon that makes sense to you (for example, to help you remember what port it is used on, in later use):



Figure 21 – New Connection Dialog Box

²¹ There is a Private Edition (available for free for non-commercial use), which you may wish to obtain; it has more features than the standard HyperTerminal – see the program's Help info. Note that HyperTerminal Private Edition was used for some of the examples on the following pages.

²² In Windows XP: Start ® All Programs ® Accessories ® Communications. In other versions of Windows, the menu sequence is similar.

Choose the COM Port which is connected to the G2's Port A:



Figure 22 – COM Port Selection Dialog Box

Set up the COM port's Baud rate, serial format (8-N-1), and flow control:

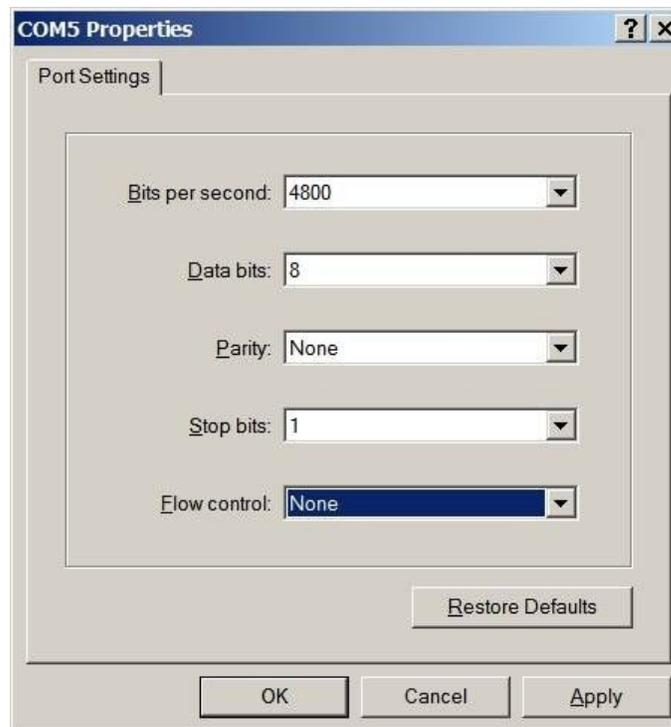

Figure 23 – COM Port Settings

The new connection's communication session will then start – but HyperTerminal is not fully set up yet for use with the G2, so click on the Disconnect button, to stop the session:



Figure 24 – Disconnect Button



Figure 25 – Call Button

Set up the remaining COM port parameters; select File ® Properties ® Settings:

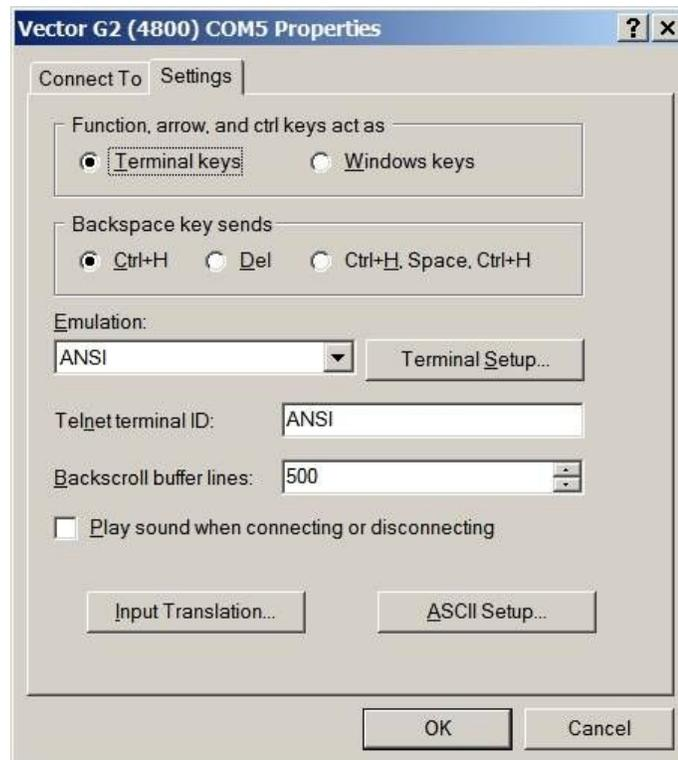

Figure 26 – COM Port Properties Dialog Box, Settings Tab

- Click on the ASCII Setup button:

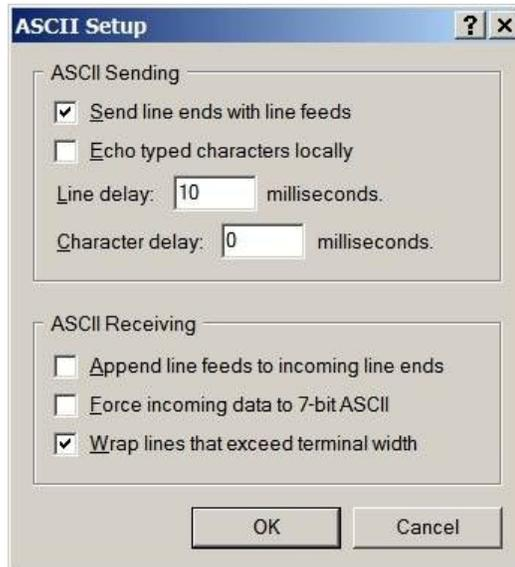

Figure 27 – COM Port ASCII Setup Dialog Box

Note: you may find that a Line Delay longer or shorter than 10 msec will be needed on your PC; you may also need to set a non-zero Character Delay.

- The other buttons on the Settings Tab do not need to be clicked, since the default parameter values on those dialogs are fine.

Exit the File ® Properties ® Settings dialog (click on the appropriate OK buttons).

Save and Re-use the Connection

Once you have finished setting up the New Connection(s) satisfactorily, you should do a manual Save, so that you have it (them) stored for subsequent use: File ® Save.

When you want to re-open a saved session: File ® Open, then select the session you want.

Alternatively, you can use File ® Save As to store the session(s) in some other folder on your PC's file system (HyperTerminal always stores New Connections in its own folder), and then navigate back to that folder when you later do a File ® Open.

Use the New Connection to the G2

Now that you have your connection set up, you can use it:

Re-start the HyperTerminal session: click on the Call button (see Figure 25).

If you want to monitor both of the G2's ports, start another HyperTerminal session, setting it up the same as above, but on another COM port (COM 6, for the G2's Port B, in the screen shots here). Position it on your PC's display so that you can see both sessions simultaneously (see Figure 28, below for an example).

Power up the G2.

After a few seconds, you should begin to see data coming from the G2 in the HyperTerminal session(s). Initially, all the data fields in the G2's output sentences will be empty; then, within a minute or so (depending on how many GPS satellites with good signal strength can be seen by the G2), the Position & Date/Time fields will start to have valid data, followed after another few minutes or so by heading data.

Note: if you are using a USB-to-Serial adapter (see page 32), you may find – depending on the brand of the adapter and/or the version of its driver software – that you must “make the Call” with the G2 disconnected from the DE9 end of the adapter, or perhaps even with the G2 turned off.

The symptom of this condition will be that HyperTerminal brings up a message box that says “Can not open COM port x” when you click on the Call button.

Using a different brand of adapter, and/or a different driver, may solve the problem.

Example Data Displays

On the following pages, there are several examples of what a typical PC display looks like while monitoring the G2's data outputs with HyperTerminal (two sessions, with Port A's on the left of Port B's, and after several minutes of operation):

The Vector Pros used for the following examples were both G2Bs, configured with the SI-TEX factory defaults on both ports (see Table 6 & Table 7). They were located outside SI-TEX's office, on the usual test site – a low bush just outside the Service Department door. Each was aligned to point approximately West, with a clear view of the Southern sky (about 200° horizontally centered on ~180° True, and about 90° vertically, from ~10° above the Southern horizon to ~100° overhead); there were some cars parked nearby, but none within 3 metres, and no other metallic surfaces nearby.

As can be seen in the example data outputs, 7 (of the 11 or 12 visible) GPS satellites' signals were used by the G2Bs in the GPS data processing & position/heading/etc. computations.

The nearest Beacon transmitter is about 6 Km away (the Canadian Coast Guard's Richmond, B.C. site), and its signal was good during all the tests.

All the tests shown in the screen shots were run with the G2B's Differential data source (JDIF) set to BEACON. Then, at a later point in the tests (shown only in some of the “typical data listing” figures), JDIF was set to WAAS; there were two SBAS satellites visible – and PRN #135 was selected by the G2B, as is usually the case here at SI-TEX.

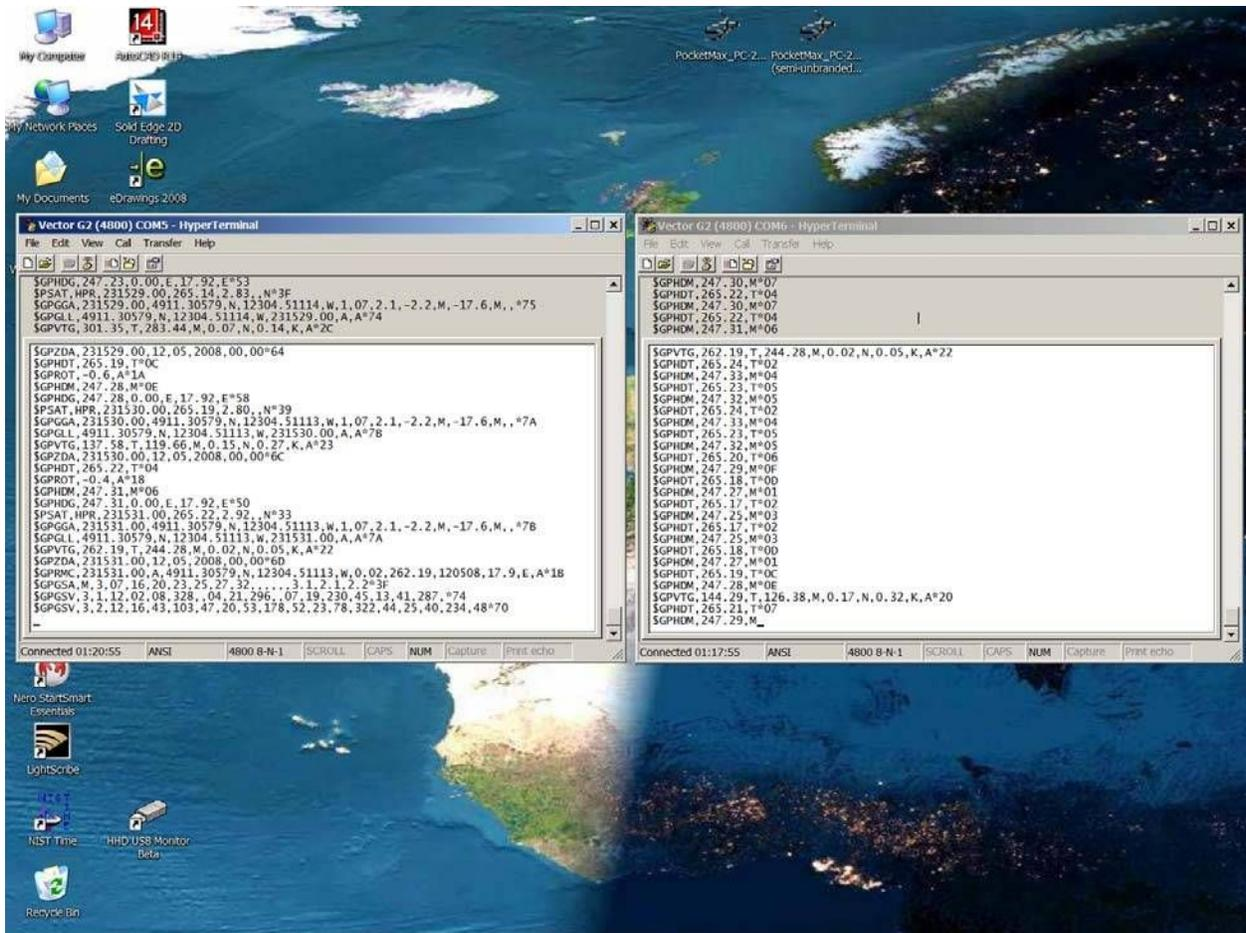

Figure 28 – A Typical Two-session Screen

Monitoring the G2

This is a more detailed look at a typical HyperTerminal session on Port A, after about an hour and a half of operation (on the laptop):

```

$GPHDM,246.90,M*0C
$GPHDG,246.90,0.00,E,17.72,E*54
$PSAT,HPR,004304.00,264.62,4.63,,N*3A
$GPGGA,004304.00,4911.30466,N,12304.51067,W,2,07,1.9,0.4,M,-17.6,M,5.8,0304*77
$GPGLL,4911.30466,N,12304.51067,W,004304.00,A,D*76
$GPVTG,294.82,T,277.10,M,0.02,N,0.03,K,D*21
$GPZDA,004304.00,15,05,2009,00,00*6F
$GPHDT,264.66,T*05
$GPROT,0.2,A*33
$GPHDM,246.94,M*08
$GPHDG,246.94,0.00,E,17.72,E*50
$PSAT,HPR,004305.00,264.66,4.44,,N*3A
$GPGGA,004305.00,4911.30466,N,12304.51067,W,2,07,1.9,0.4,M,-17.6,M,5.6,0304*78
$GPGLL,4911.30466,N,12304.51067,W,004305.00,A,D*77
$GPVTG,340.51,T,322.79,M,0.09,N,0.17,K,D*27
$GPZDA,004305.00,15,05,2009,00,00*6E
$GPRMC,004305.00,A,4911.30466,N,12304.51067,W,0.09,340.51,150509,17.7,E,D*18
$GPGSA,M,3,03,07,08,13,19,23,25,,,,,2.8,1.9,2.0*3E
$GPGSV,3,1,12,03,30,086,48,06,25,068,,07,78,303,52,08,38,267,48*76
$GPGSV,3,2,12,10,23,312,,13,66,136,53,16,13,044,,19,20,114,46*72
$GPGSV,3,3,12,23,30,134,50,24,01,340,,25,73,056,50,28,09,210,37*7A
$GPGST,004305.00,0.4,0.6,0.3,6.9,0.6,0.3,0.7*59
$GPHDT,264.63,T*00
$GPROT,0.2,A*33
$GPHDM,246.91,M*0D
$GPHDG,246.91,0.00,E,17.72,E*55
$PSAT,HPR,004306.00,264.63,4.48,,N*30
$GPGGA,004306.00,4911.30466,N,12304.51067,W,2,07,1.9,0.3,M,-17.6,M,6.0,0304*79
$GPGLL,4911.30466,N,12304.51067,W,004306.00,A,D*74
$GPVTG,259.78,T,242.06,M,0.06,N,0.11,K,D*23_
    
```

Figure 29 – Typical Port A Session

This is a more detailed look at the matching session on Port B:

```

$GPHDM,247.02,M*06
$GPHDT,264.74,T*06
$GPHDM,247.02,M*06
$GPHDT,264.73,T*01
$GPHDM,247.01,M*05
$GPVTG,42.22,T,24.50,M,0.05,N,0.09,K,D*2F
$GPHDT,264.74,T*06
$GPHDM,247.02,M*06
$GPHDT,264.74,T*06
$GPHDM,247.02,M*06
$GPHDT,264.74,T*06
$GPHDM,247.02,M*06
$GPHDT,264.72,T*00
$GPHDM,247.00,M*04
$GPHDT,264.72,T*00
$GPHDM,247.00,M*04
$GPHDT,264.72,T*00
$GPHDM,247.00,M*04
$GPHDT,264.71,T*03
$GPHDM,246.99,M*05
$GPHDT,264.71,T*03
$GPHDM,246.99,M*05
$GPHDT,264.70,T*02
$GPHDM,246.98,M*04
$GPHDT,264.71,T*03
$GPHDM,246.99,M*05
$GPVTG,356.16,T,338.44,M,0.06,N,0.12,K,D*2C
$GPHDT,264.71,T*03
$GPHDM,246.99,M*05
$GPHDT,264.71_
    
```

Figure 30 – Typical Port B Session

Capturing Data Output from the G2

One of the problems with using HyperTerminal is that it's hard to watch individual sentences, or inspect them carefully – because the data keeps coming out of the G2, so the text in the HyperTerminal's "screen" area is constantly changing, as new data comes in and the older data scrolls up (& eventually off) the active display area.

Or, you might want to "capture" the output from the G2 over along period of time – for example, to look how position &/or heading changed during a voyage, in order to check if your autopilot is properly adjusted for your boat.

To look at data in these ways, it's necessary to use HyperTerminal's Capture Text function:

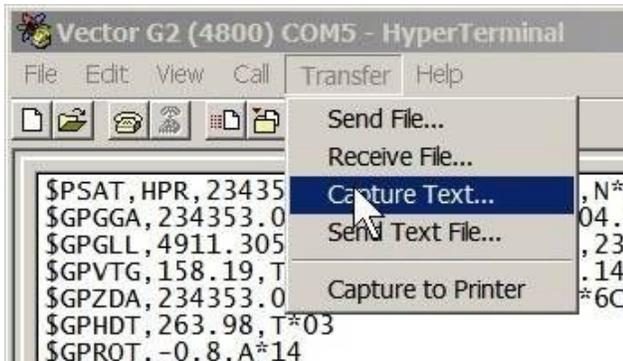

Figure 31 – Capturing the G2's Output

Enter a file name, & Browse to a folder (in which to store the captured text) that will be easy to find later.²³

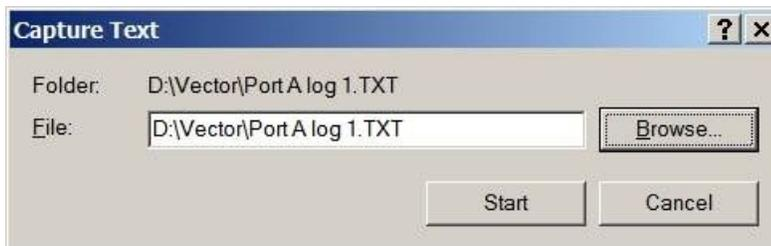

Figure 32 – Choosing a Filename & Location for Captured Output

On most modern PCs, with the typical hard disk of at least 80 GB, you could keep capturing the G2's output for a very long time, without running out of storage space. At 4800 Baud, the G2 puts out about 25 KB per minute, or ~1.5 MB per hour, ~36 MB per day.

Note: it may be hard to look at files bigger than 10 MB or so, later on (with ordinary text editors, at least).

²³ You could also use HyperTerminal's standard "storage" folder, although that can be hard to find, as it is usually located somewhere in the "system" folders on the main hard drive, e.g., C:\Program Files\Windows NT\HyperTerminal\

This is 5 seconds (i.e., one full sequence of all the factory-default enabled sentences) of typical output from Port A, captured into a text file (see also the examples on page 85):

```
$GPHDT,264.09,T*0C
$GPROT,-2.4,A*1A
$GPHDM,246.37,M*01
$GPHDG,246.37,0.00,E,17.72,E*59
$PSAT,HPR,232346.00,264.09,6.88,,N*31
$GPGGA,232346.00,4911.30205,N,12304.50987,W,2.05,2.5,4.3,M,-17.6,M,5.8,0304*7D
$GPGLL,4911.30205,N,12304.50987,W,232346.00,A,D*72
$GPVTG,1.56,T,343.84,M,0.14,N,0.26,K,D*2D
$GPZDA,232346.00,14,05,2009,00,00*6F
$GPHDT,264.10,T*04
$GPROT,18.9,A*01
$GPHDM,246.38,M*0E
$GPHDG,246.38,0.00,E,17.72,E*56
$PSAT,HPR,232347.00,264.10,7.08,,N*31
$GPGGA,232347.00,4911.30205,N,12304.50986,W,2.05,2.5,4.3,M,-17.6,M,5.6,0304*73
$GPGLL,4911.30205,N,12304.50986,W,232347.00,A,D*72
$GPVTG,301.26,T,283.54,M,0.10,N,0.18,K,D*20
$GPZDA,232347.00,14,05,2009,00,00*6E
$GPHDT,264.00,T*05
$GPROT,-5.9,A*10
$GPHDM,246.28,M*0F
$GPHDG,246.28,0.00,E,17.72,E*57
$PSAT,HPR,232348.00,264.00,7.02,,N*35
$GPGGA,232348.00,4911.30205,N,12304.50984,W,2.05,2.5,4.4,M,-17.6,M,6.0,0304*7C
$GPGLL,4911.30205,N,12304.50984,W,232348.00,A,D*7F
$GPVTG,217.12,T,199.40,M,0.18,N,0.33,K,D*2D
$GPZDA,232348.00,14,05,2009,00,00*6I
$GPHDT,264.27,T*00
$GPROT,0.6,A*37
$GPHDM,246.55,M*05
$GPHDG,246.55,0.00,E,17.72,E*5D
$PSAT,HPR,232349.00,264.27,6.72,,N*37
$GPGGA,232349.00,4911.30203,N,12304.50982,W,2.05,2.5,4.4,M,-17.6,M,5.8,0304*76
$GPGLL,4911.30203,N,12304.50982,W,232349.00,A,D*7E
$GPVTG,121.77,T,104.05,M,0.13,N,0.24,K,D*20
$GPZDA,232349.00,14,05,2009,00,00*60
$GPHDT,264.32,T*04
$GPROT,18.7,A*0F
$GPHDM,246.60,M*03
$GPHDG,246.60,0.00,E,17.72,E*5B
$PSAT,HPR,232350.00,264.32,6.48,,N*32
$GPGGA,232350.00,4911.30203,N,12304.50979,W,2.05,2.5,4.5,M,-17.6,M,5.6,0304*75
$GPGLL,4911.30203,N,12304.50979,W,232350.00,A,D*72
$GPVTG,308.82,T,291.10,M,0.04,N,0.07,K,D*2F
$GPZDA,232350.00,14,05,2009,00,00*68
$GPRMC,232350.00,A,4911.30203,N,12304.50979,W,0.04,308.82,140509,17.7,E,D*13
$GPGSA,M,3,03,07,13,20,23,,,,,3.9,2.5,3.0*35
$GPGSV,3,1,12,01,15,108,,02,05,330,,03,10,118,45,04,10,270,*78
$GPGSV,3,2,12,07,46,250,49,08,49,246,,13,74,314,49,20,19,176,43*76
$GPGSV,3,3,12,23,66,108,53,25,03,069,,27,85,302,,32,03,160,*73
$GPGST,232350.00,1.1,2.4,1.1,347.9,2.4,1.2,3.2*59
```

This is 1 second (i.e., one full sequence of all the factory-default enabled sentences) of typical output from Port B, captured approximately simultaneously with Port A above:

```
$GPHDT,264.05,T*00
$GPHDM,246.33,M*05
$GPHDT,264.09,T*0C
$GPHDM,246.38,M*0E
$GPHDT,264.12,T*06
$GPHDM,246.41,M*00
$GPHDT,264.21,T*06
$GPHDM,246.49,M*08
$GPHDT,264.21,T*06
$GPHDM,246.49,M*08
$GPHDT,264.21,T*06
$GPHDM,246.50,M*00
$GPHDT,264.23,T*04
$GPHDM,246.51,M*01
$GPHDT,264.29,T*0E
$GPHDM,246.57,M*07
$GPHDT,264.32,T*04
$GPHDM,246.60,M*03
$GPHDT,264.34,T*02
$GPHDM,246.62,M*01
$GPVTG,273.73,T,256.02,M,0.08,N,0.15,K,D*2B
```

Sending Commands to the G2

Another problem when using HyperTerminal with a G2 is that it's hard to simply "type" commands to the G2.

That's because HyperTerminal is a "dumb terminal" program – it depends on the device it is "talking to" (the G2, in this case) for "editing user input" ... hit a key on the keyboard, and that character immediately gets sent out to the G2.

But the G2 does not have an "input editor" function (i.e., the Backspace & Delete keys mean nothing to it), so you can not correct any wrong characters which you happen to type. Nor does the G2 echo any characters it receives back out to the PC ... so you can't even see what you're typing²⁴ And it's even worse, if you are trying to type commands while the G2 is sending a continuous stream of data ...

The solution to this is to use "script" files – simple text files, containing the command(s) that you want to send to the G2, which you can create with any text editor (e.g., Notepad, WordPad, Word²⁵, etc. on a PC).

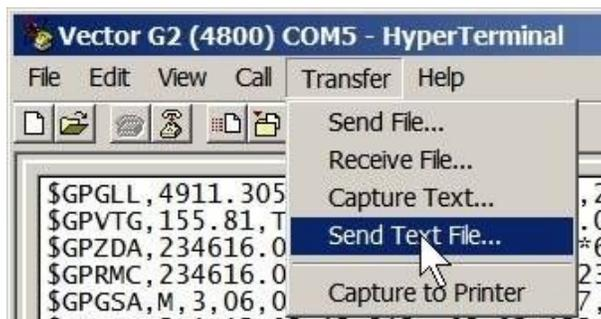

Figure 33 – Sending a Command File

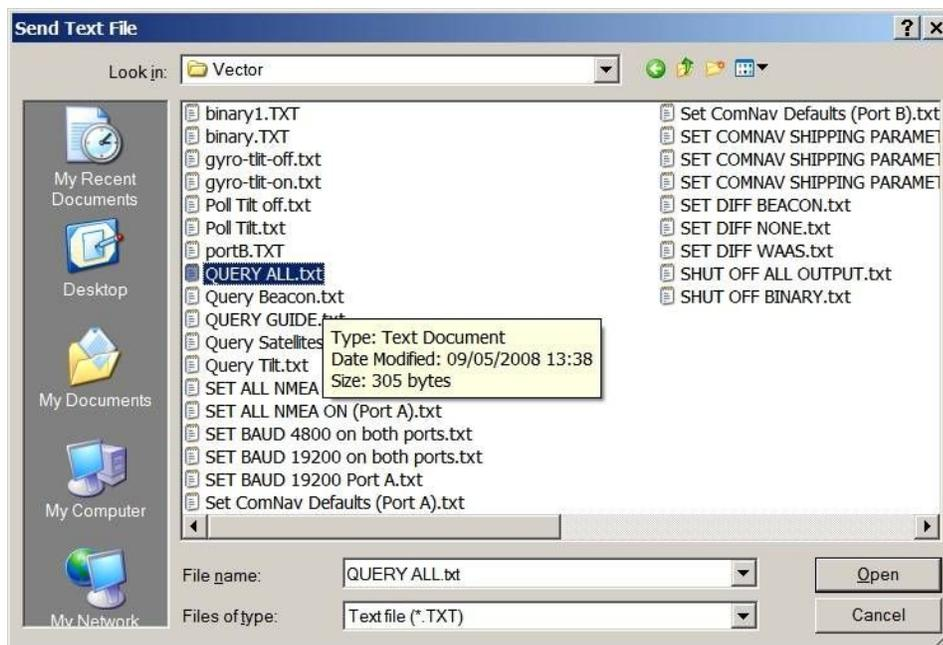

Figure 34 – Choosing the Command File to Send

²⁴ ... unless you set HyperTerminal to echo the keys you type onto the PC display (which can cause other problems).

²⁵ With MS Word®, be sure to save your script files as "simple text"; Word 2003 calls these "plain text (*.txt)" in the Save As dialog, older versions of Word called them "MS-DOS text (*.txt)" or something similar. Word's normal default file format is "Word document (*.doc)", which will not work properly in HyperTerminal with a G2.

Some sample script files we use when working with the G2 at SI-TEX are shown below. Please feel free to use them in your own work with the G2!

For a description of the individual commands here, see Table 8 thru Table 13, and the GPS Technical Reference.

- ® Tip: when using the various “status” scripts below, it’s often easiest if you first temporarily disable all the G2’s currently updating Navigation data sentences, using the All Off or Port A Off scripts. That way, you can “see” the status responses, and inspect them carefully.

Note: if you do use either of the “Off” scripts, then none of the output sentences enabled in the G2’s current power-on configuration settings for Port A will show up, in the Query All response, since those sentences are – at the time of the query – disabled. However, unless you send a \$JSAVE command to the G2 before you do a power-off/on cycle, all those “current” sentences will re-start, after power-on. Keep in mind that there is no way to determine the G2’s saved configuration, except by observing what it does on power-up!

- 1) All Off.txt – shuts off all output sentences, on both ports:

```
$JOFF
$JOFF,OTHER
$PCSI,1,0
$PCSI,2,0
```

- 2) Port A Off.txt – shuts off all output sentences, on Port A:

```
$JOFF
$PCSI,1,0
$PCSI,2,0
```

- 3) Query All.txt – lists the G2’s important configuration & status parameters:

Note: in this & some other example scripts, there are two versions given, depending on which generation of the G2 is being used (see Appendix 3).

2nd & 3rd Generation

```
$JT
$JI
$JAPP
$JQUERY,GUIDE
$JSHOW
$JGEO,ALL
$JWAASPRN
$JATT,COGAID
$JATT,GYROAID
$JATT,TILTAID
$JATT,COGTAU
$JATT,HTAU
$JATT,HRTAU
$JATT,PTAU
$JATT,SPDTAU
$JATT,HBIAS
$JATT,PBIAS
$JATT,CSEP
$JATT,MSEP
$JATT,LEVEL
$JATT,NEGTILT
$JATT,ROLL
$JATT,HDMTRUE
$JATT,NMEAHE
```

1st Generation

```
$JT
$JI
$JAPP
$JQUERY,GUIDE
$JSHOW
$JGEO,ALL
$JWAASPRN
$JATT,GYROAID
$JATT,MAGAID
$JATT,TILTAID
$JATT,COGTAU
$JATT,HTAU
$JATT,HRTAU
$JATT,PTAU
$JATT,SPDTAU
$JATT,HBIAS
$JATT,PBIAS
$JATT,CSEP
$JATT,MSEP
$JATT,LEVEL
$JATT,NEGTILT
$JATT,ROLL
```

- 4) Query DGPS.txt – shows the current status of the SBAS functions : ²⁶

```
$JASC,D1,1
█
$JASC,D1,0
```

- 5) Query Beacon.txt – shows the current status of the Beacon receiver (in the G2B only):

```
$PCSI,1,1
$PCSI,2,1
$PCSI,1,0
$PCSI,2,0
```

- 6) Query Tilt.txt – shows the current readings from the tilt sensor:

```
$JASC,INTLT,1
█
$JASC,INTLT,0
```

- 7) Query Satellites.txt – shows the current “satellites” status:

```
$JASC,GPDTM,5
$JASC,GPGBS,5
$JASC,GPGGA,5
$JASC,GPRGS,5
$JASC,GPGSA,5
$JASC,GPGST,5
$JASC,GPGSV,5
$JASC,GPRRE,5
█
$JASC,GPDTM,0
$JASC,GPGBS,0
$JASC,GPGGA,0
$JASC,GPRGS,0
$JASC,GPGSA,0
$JASC,GPGST,0
$JASC,GPGSV,0
$JASC,GPRRE,0
```

- 8) Set SI-TEX Defaults (Port A).txt – configures the G2 with the factory defaults:

2 nd & 3 rd Generation	1 st Generation
\$JOFF	\$JOFF
\$PCSI,1,0	\$PCSI,1,0
\$PCSI,2,0	\$PCSI,2,0
\$JASC,GPGGA,1	\$JASC,GPGLL,1
\$JASC,GPGLL,1	\$JASC,HCHDM,5
\$JASC,GPGSA,0.2	\$JASC,HEHDT,5
\$JASC,GPGST,0.2	\$JASC,HEROT,5
\$JASC,GPGSV,0.2	\$JATT,GYROAID,YES
\$JASC,GPRMC,0.2	\$JATT,MAGAID,NO
\$JASC,GPVTG,1	\$JATT,TILTAID,YES
\$JASC,GPZDA,1	\$JATT,ROLL,NO
\$JASC,GPHDG,1	\$JATT,HBIAS,0.0
\$JASC,GPHDM,1	\$JATT,PBIAS,0.0
\$JASC,GPHDT,1	\$JDIFF,NONE 1
\$JASC,GPROT,1	
\$JASC,HPR,1	
\$JATT,COGAID,NO	
\$JATT,GYROAID,YES	
\$JATT,TILTAID,YES	
\$JATT,ROLL,NO	
\$JATT,HBIAS,0.0	
\$JATT,PBIAS,0.0	
\$JATT,HDMTRUE,NO	
\$JATT,NMEAHE,NO	
\$JDIFF,NONE 1	

1 \$JDIFF,BEACON for a G2B

²⁶ In this and some other scripts, it is necessary to insert some “empty lines” between the two commands shown, to allow the G2 sufficient time to recognize the “enable” command, and start to respond to it, before it receives the subsequent “disable” command. On the test PCs at SI-TEX, this requires ~20 empty lines between the two commands. On your PC, it may be different, so you may have to experiment with it. The empty lines are indicated here with the █ symbol.

9) Set SI-TEX Defaults (Port B).txt – configures the G2 with the factory defaults:

2 nd & 3 rd Generation	1 st Generation
\$JOFF, OTHER	\$JOFF, OTHER
\$PCSI, 1, 0, OTHER	\$PCSI, 1, 0, OTHER
\$PCSI, 2, 0, OTHER	\$PCSI, 2, 0, OTHER
\$JASC, GPHDM, 10, OTHER	\$JASC, HCHDM, 5, OTHER
\$JASC, GPHDT, 10, OTHER	\$JASC, HEHDT, 5, OTHER
\$JASC, GPVTG, 1, OTHER	\$JASC, HEROT, 5, OTHER
	\$JASC, GPVTG, 1, OTHER

10) Set DGPS Beacon.txt – configures the G2B with the factory-default DGPS setting:

```
$JDIFF, BEACON
```

11) Set DGPS SBAS.txt – switches the DGPS setting to SBAS:

```
$JDIFF, WAAS
```

12) Set DGPS Autonomous.txt – switches the DGPS setting to Autonomous:

```
$JDIFF, NONE
```

13) Set 4800 on Both.txt – sets both port's Baud rates to the factory-default of 4800 :²⁷

```
$JBAUD, 4800, OTHER
$JBAUD, 4800
```

14) Set 19200 on Both.txt – sets both port's Baud rates to 19200:

```
$JBAUD, 19200, OTHER
$JBAUD, 19200
```

15) Set All NMEA On.txt – enables all non-binary “navigation” (NMEA & proprietary) output sentences²⁸:

```
$JASC, GPDTM, 1
$JASC, GPGGA, 1
$JASC, GPGLL, 1
$JASC, GPGNS, 1
$JASC, GPGRS, 1
$JASC, GPGSA, 1
$JASC, GPGST, 1
$JASC, GPGSV, 1
$JASC, GPHDG, 1
$JASC, GPHDM, 1
$JASC, GPHDT, 1
$JASC, GPRMC, 1
$JASC, GPROT, 1
$JASC, GPRRE, 1
$JASC, GPVTG, 1
$JASC, GPZDA, 1
$JASC, D1, 1
$JASC, GPGBS, 1
$JASC, HPR, 1
$JASC, INTLT, 1
$PCSI, 1, 1
$PCSI, 2, 1
```

²⁷ Remember that when changing Baud rates, you will have to change HyperTerminal's Baud rate to match the G2, if the G2's new Baud rate is different than what it is when the command is sent. Disconnect the session, change the rate in File ® Properties ® Configure, then re-start the session with the Call button. On some PCs, you may have to exit HyperTerminal completely, & then re-start it.

²⁸ You will have to be running the G2 & Hyperterminal at a Baud rate of at least 19200 when you use this script, since the total bandwidth from the G2 with all these outputs enabled is ~1245 bytes/sec (see page 61 for more details on Baud rates & data bandwidth).

Example Responses

The following are examples of the G2's typical responses to some of the scripts above, and to single commands entered manually.

- 1) This is the output from a Query All script (all normal output had been disabled before this, with an All Off script – see page 81):

```
$>JT, SX2a
$>JI, 390639, 1, 7, 24012008, 01/01/1900, 01/01/3000, 1.5d, 46
$>JAPP, ATTITH20, ATTITH20, 2, 1
$>JQUERY, GUIDE, NO
$>JSHOW, BAUD, 4800
$>JSHOW, BAUD, 4800, OTHER
$>JSHOW, BAUD, 19200, PORTC
$>JSHOW, DIFF, WAAS
$>JSHOW, ALT, NEVER
$>JSHOW, LIMIT, 10.0
$>JSHOW, MASK, 5
$>JSHOW, POS, 49.2, -123.1
$>JSHOW, AIR, AUTO, NORM
$>JSHOW, SMOOTH, LONG900
$>JSHOW, FREQ, 1575.4200, 250
$>JSHOW, AGE, 2700
$>JSHOW, THISPORT, PORTA
$>JGEO, Sent=1575.4200, Used=1575.4200, PRN=135, Lon=-132, E1=32.8, Az=193.0
$>JGEO, Sent=1575.4200, Used=1575.4200, PRN=138, Lon=-107, E1=31.6, Az=159.5
$>JWAASPRN, 135, 138, AUTO
$>JATT, COGAID, NO
$>JATT, GYROAID, YES
$>JATT, TILTAID, YES
$>JATT, COGTAU, 0.000
$>JATT, HTAU, 2.000
$>JATT, HRTAU, 2.000
$>JATT, PTAU, 0.500
$>JATT, SPDTAU, 0.000
$>JATT, HBIAS, 0.000
$>JATT, PBIAS, 0.000
$>JATT, CSEP, 0.500
$>JATT, MSEP, 0.500
$>JATT, FLIPBRD, YES
$>JATT, LEVEL, NO
$>JATT, NEGILT, NO
$>JATT, ROLL, NO
$>JATT, HDMTRUE, NO
$>JATT, NMEAHE, NO
```

- 2) This the G2's reply when you ask it what is the current source of DGPS correction data, with a \$JDIFF command (the current source is SBAS):

```
$>JDIFF, WAAS
```

- 3) This is the G2's reply when you set it to use Roll->Port alignment (see page 58):

```
$>JATT, ROLL, OK
$>JATT, HBIAS, OK
```

If you then query the current Roll & HBIAS status, by sending it \$JATT,ROLL & then \$JATT,HBIAS commands, here's the reply:

```
$>JATT, ROLL, YES
$>JATT, HBIAS, 90.000
```

- 4) Here is the G2's reply when you enter an invalid command :²⁹

```
$> Unknown Command, Please Check and Re-Enter
```

- 5) Here is the G2's reply when you enter an incomplete command:

```
$> Insufficient Arguments, Please Re-enter
```

²⁹ ... usually – but please be aware that, in some “bad command” situations, the G2 does not reply at all.

- 6) Here is the G2's reply when you enter a \$JSAVE command:

```
(normal data output ... whatever is currently configured)
...
...
$> Saving Configuration. Please wait...
...
...
(normal data output continues for ~5 seconds)
...
...
$> Save Complete
...
...
(normal data output continues)
```

- 7) Here is a typical power-on sequence from Port A (configured with the SI-TEX factory default settings):

Note: the time intervals shown here are more or less normal; in your installation, they may be shorter or longer, depending on the G2's location, its sky view, current GPS signal reception conditions, and so on.

the first several seconds are mostly all Null data. Also, GSV does not appear below (it often does not start immediately, even though there may be many visible satellites):

```
$GPHDT,,T*1B
$GPROT,,V*08
$GPHDM,,M*1B
$GPHDG,,E,,E*70
$PSAT,HPR,,,,*5C
$GPGGA,,,,,0,,,M,,M,,*66
$GPGLL,,,,,V,N*64
$GPVTG,,T,,M,,N,,K,N*2C
$GPZDA,,,,,00,00*48
$GPHDT,,T*1B
$GPROT,,V*08
$GPHDM,,M*1B
$GPHDG,,E,,E*70
$PSAT,HPR,,,,*5C
$GPGGA,,,,,0,,,M,,M,,*66
$GPGLL,,,,,V,N*64
$GPVTG,,T,,M,,N,,K,N*2C
$GPZDA,,,,,00,00*48
$GPHDT,,T*1B
$GPROT,,V*08
$GPHDM,,M*1B
$GPHDG,,E,,E*70
$PSAT,HPR,,,,*5C
$GPGGA,,,,,0,,,M,,M,,*66
$GPGLL,,,,,V,N*64
$GPVTG,,T,,M,,N,,K,N*2C
$GPZDA,,,,,00,00*48
$GPHDT,,T*1B
$GPROT,,V*08
$GPHDM,,M*1B
$GPHDG,,E,,E*70
$PSAT,HPR,,,,*5C
$GPGGA,,,,,0,,,M,,M,,*66
$GPGLL,,,,,V,N*64
$GPVTG,,T,,M,,N,,K,N*2C
$GPZDA,,,,,00,00*48
$GPRMC,,V,,,,,,N*53
$GPGSA,M,1,,,,,,*12
$GPGST,,,,,,*57
```

after a few more seconds, the ZDA & HPR sentences begin to have valid time/date data, and GSV appears:

```
$GPHDT,,T*1B
$GPROT,,V*08
$GPHDM,,M*1B
$GPHDG,,E,,E*70
$PSAT,HPR,232248.78,,,,*70
$GPGGA,,,,,0,,,,M,,*66
$GPGLL,,,,,V,N*64
$GPVTG,,T,,M,,N,,K,N*2C
$GPZDA,232248.78,14,05,2009,00,00*6F
$GPHDT,,T*1B
$GPROT,,V*08
$GPHDM,,M*1B
$GPHDG,,E,,E*70
$PSAT,HPR,232249.78,,,,*71
$GPGGA,,,,,0,,,,M,,*66
$GPGLL,,,,,V,N*64
$GPVTG,,T,,M,,N,,K,N*2C
$GPZDA,232249.78,14,05,2009,00,00*6E
$GPRMC,,V,,,,,,,,,N*53
$GPGSA,M,1,,,,,,,,,,,,,*12
$GPGSV,3,1,12,01,16,108,,02,05,331,,03,06,124,44,04,10,270,*73
$GPGSV,3,2,12,08,49,246,,13,53,300,,20,14,172,38,23,82,322,*79
$GPGSV,3,3,12,24,01,229,,25,03,069,,27,85,301,,32,04,160,*77
$GPGST,,,,,,,,,*57
```

output continues like that for another ~30 seconds, then position, speed³⁰, COG & more satellite data begins to appear, in the GGA, GLL, VTG, RMC, GSA & GST sentences:

```
$GPHDT,,T*1B
$GPROT,,V*08
$GPHDM,,M*1B
$GPHDG,,E,,E*70
$PSAT,HPR,232334.77,,,,*75
$GPGGA,232334.77,4911.30164,N,12304.50975,W,2,05,2.5,5.0,M,-17.7,M,4.8,0304*73
$GPGLL,4911.30164,N,12304.50975,W,232334.77,A,D*7E
$GPVTG,29.03,T,10.95,M,0.27,N,0.50,K,D*23
$GPZDA,232334.77,14,05,2009,00,00*6A
$GPRMC,232334.77,A,4911.30164,N,12304.50975,W,0.27,29.03,140509,,D*7D
$GPGSA,M,3,03,07,13,20,23,,,,,,,,,3.9,2.5,3.0*35
$GPGSV,3,1,12,01,15,108,,02,05,331,,03,10,118,45,04,10,270,*79
$GPGSV,3,2,12,07,46,250,48,08,49,246,,13,74,313,49,20,19,176,41*72
$GPGSV,3,3,12,23,66,108,53,25,03,069,,27,85,301,,32,03,160,*70
$GPGST,232334.77,3.0,6.7,3.0,348.0,6.5,3.3,8.9*5C
```

and a few seconds later, the RTK-based heading & pitch data begins to appear, in the HDT, ROT, HDM, HDG and HPR sentences:

```
$GPHDT,263.77,T*02
$GPROT,-0.8,A*14
$GPHDM,245.69,M*09
$GPHDG,263.77,,E,0.00,E*77
$PSAT,HPR,232342.00,263.77,7.93,,N*30
```

³⁰ ... although the speed & COG data in this example is invalid, since the G2 was not moving during this output capture sequence (see the footnote on page 42, and the note after Table 18 on page 60).

- 8) Here is a typical power-on sequence from Port B (captured simultaneously with the Port A sequence above):

the first second is all Null data:

```
$GPHDT,,T*1B
$GPHDM,,M*1B
$GPHDT,,T*1B
$GPHDM,,M*1B
$GPHDT,,T*1B
$GPHDM,,M*1B
$GPHDT,,T*1B
$GPHDM,,M*1B
$GPHDT,,T*1B
$GPHDM,,M*1B
$GPHDT,,T*1B
$GPHDM,,M*1B
$GPHDT,,T*1B
$GPHDM,,M*1B
$GPHDT,,T*1B
$GPHDM,,M*1B
$GPHDT,,T*1B
$GPHDM,,M*1B
$GPHDT,,T*1B
$GPHDM,,M*1B
$GPHDT,,T*1B
$GPHDM,,M*1B
$GPHDT,,T*1B
$GPHDM,,M*1B
$GPHDT,,T*1B
$GPHDM,,M*1B
$GPVTG,,T,,M,,N,,K,N*2C
```

after ~35 seconds more, the VTG sentence begins to have valid speed & COG data:

```
$GPHDM,,M*1B
$GPHDT,,T*1B
$GPHDM,,M*1B
$GPVTG,29.03,T,10.95,M,0.27,N,0.50,K,D*23
```

and after a few seconds more, the RTK-based heading data begins to appear, in the HDM & HDT sentences:

```
$GPHDT,,T*1B
$GPHDM,,M*1B
$GPHDT,263.44,T*02
$GPHDM,245.37,M*02
```

Note: as you can see in the example outputs above, the “position”, “heading” & other output data is initially Null values – i.e., the respective fields in the NMEA sentences are empty.

Yet the sentences still have proper structure and format, including correct checksums.

Some NMEA equipment may accept these sentences as “valid”, and not generate any “invalid data”, “lost heading” or similar alarms or warnings.

Other equipment may react to them with such alarms &/or warnings!!

 **CAUTION!** Although the examples above were captured during a power-on sequence, the same “Null heading” (empty fields) behaviour occurs whenever the G2 encounters a GPS signal blockage; for example, when passing under a bridge, or if the vessel is in a narrow channel with high sides that block most of the sky view, or similar).

The Null heading condition can also occur, randomly, when there are strong multi-path reflections (see page 41).

Note that if the Gyro sensor is enabled in such circumstances, the Null heading condition will not occur for 3 minutes after loss-of-signal (see page 44).

Appendix 3

Vector Pro Model Generations

To date, there have been 3 generations of the Vector Pro G2 & G2B GPS Compasses. All are named “Vector Pro G2” (or “Vector Pro G2B”), and all use the same SI-TEX part numbers; for example, PN 11210001 is a Vector Pro G2 with 15m cable & mounting brackets, irrespective of generation.

Identifying Generations

The model generations can only be distinguished by the serial number, which is located on the label on the underside of the enclosure.

- ® The serial number is in the format YYWW -nnnn-nnnn (the number of digits in the “n” fields can vary). The first four digits of the serial number indicate the year and week of manufacture: YYWW means week WW of year 20YY.

A first-generation model has a serial number with the first four digits being less than 0722. For Installation & Operation information on those first-generation models, please refer to revision 1.2 of this manual.

The second-generation model has a serial number with the first four digits being greater than 0722, but less than 0902. For information on those second-generation models, please refer to revision 1.6 (with Addendum #1) of this manual.

The third-generation model has a serial number with the first four digits being 0902, or some higher four-digit code. Revision 2.0 (or later) of this manual is applicable primarily to the third generation (& possibly later) of the Vector Pro G2 & G2B GPS Compasses.

Differences between Generations

All Vector Pro G2 & G2B GPS Compasses are customised OEM versions of certain GPS Compasses made by Hemisphere GPS™ (formerly CSI Wireless), of Calgary, Alberta, Canada and Scottsdale, Arizona, U.S.A.:

- The first-generation SI-TEX Vector Pro G2 is based on Hemisphere’s Vector Pro GPS Compass, while the SI-TEX Vector Pro G2B is based on the Vector Pro PRO. All these models use Hemisphere’s SLX GPS receiver technology.
- The second-generation Vector Pro G2 is based on Hemisphere’s initial MV100 series (using their Crescent™ GPS receiver technology) – the G2 on the MV100, the G2B on the MV110.
- The third-generation Vector Pro G2 is based on Hemisphere’s subsequent minor update of the MV100 series – the G2 on that MV100, the G2B on that MV110. The third-generation G2/G2Bs also were shipped with an improved factory-default configuration³¹.
- All SI-TEX Vector Pros have differences from the corresponding Hemisphere models, in their operational specifications & factory-default configuration settings; for details, please refer to the respective SI-TEX & Hemisphere models’ specifications.
- SI-TEX Vector Pros do not support any of Hemisphere’s various optional GPS/DGPS receiver features or subscription applications (e-Dif, OmniSTAR, L-Dif™, etc.).

³¹ Some of the later 2nd generation Vector Pros were the updated MV100/110s, but were still shipped with the original (2006) factory-default G2/G2B configuration settings. The rest were shipped with the improved configuration – in particular, any 08xx units still in stock at SI-TEX at the time the new configuration was implemented, April 2009.

The significant differences in features & operating specifications between the three generations of SI-TEX Vector Pro G2 & G2B GPS Compasses are listed below.

Feature	Generation		
	First	Second	Third
Operating Voltage	8 – 40 VDC	10 – 36 VDC	11 – 36 VDC
Power Consumption	< 4.5 W	< 5 W	< 4.5 W
Operating Temperature	-30° C to +70° C	-32° C to +74° C	-32° C to +74° C
Max Update Rate, Position	5 Hz	10 Hz	20 Hz
Max Update Rate, Heading	10 Hz	10 Hz	20 Hz
Max Rate of Turn	25 °/s	90 °/s	90 °/s
GPS Horizontal Accuracy (autonomous, no SA)	5 m, 95%	2.5 m RMS	2.5 m RMS
GPS Horizontal Accuracy (DGPS in use)	1 m, 95%	1 m RMS	1 m RMS
Compass Safe Distance	not specified	125 cm	Standard: 1.25 m Steering: 0.80 m
Compass Safe Distance (reduced)	not specified	not specified	Standard: 0.75 m Steering: 0.50 m
Beacon Receiver (G2B)	SBX-3	SBX-4	SBX-4
Beacon Receiver Standard	—	IEC 61108-4	IEC 61108-4
RS-232C Serial Ports	2 full-duplex, 1 half-duplex	2 full-duplex	2 full-duplex
Baud Rates (RS-232 & RS-422 Outputs)	4800, 9600, 19200	4800, 96001 , 192001 , 384001	4800, 96001 , 192001 , 384001
Data I/O Protocol	NMEA 0183, SLX Binary	NMEA 0183, Crescent Binary	NMEA 0183, Crescent Binary
Talker ID for NMEA 0183 Heading Sentences	HE/HC	HE/HC, GP (default: HE/HC)	HE/HC, GP (default: GP)
Invalid Heading Alarm Output 2	No	Yes	Yes
1 PPS Output 2	Yes No No		
Magnetic Aiding (Magnetometer Sensor)	Yes No No		

Table 24 – Differences between Vector Pro G2 Generations

- 1 On the second & third-generation G2/G2B, only 4800 Baud is guaranteed to work with the SI-TEX SI-TEX SP36, Admiral P3 & 5001 autopilots, and on other SI-TEX autopilots which use the Sine-Cosine Converter. The other Baud rates may or may not work on other NMEA 0183 compliant equipment.
- 2 Whether the heading/power Alarm output, or the 1 PPS output, are available on a given model depends on the cable used (see the Notes below Table 26 on page 91, and the Note at the bottom of page 92).

The first & second generation G2 & G2B also had different factory-default output sentences enabled than does the third generation (see pages 46 & 47):

Port A:

- GPGLL, GPVTG & GPZDA at 1 Hz
- HCHDM, HEHDT & HEROT at 5 Hz

Port B: HCHDM, HEHDT & HEROT at 5 Hz

The first-generation G2 & G2B did not support HEHDG, and the update rates for GPGSV and some other sentences could only be set to 0, or to 1 Hz.

Differences between Cables

There have been five different standard cables supplied with SI-TEX Vector Pro G2 & G2B GPS Compasses, across the three generations – three 15 metre cables, and two 30 metre cables.

The main difference between the various cables is in the colour-coding of the wires. The wire colour codes depend on the cable's "marking" number (which is in fact the Hemisphere GPS part number) on the cable's label. However, all cables of a given length have the same SI-TEX part number, regardless of colour coding or marking.

Part Number	31110039 31110040	
Length	15 metres	30 metres
Marking 1	051-0063-003 051-0063-004 051-0157-002 051-0098-001 051-0158-001	

Table 25 – Cable Types

- The Marking is on a plastic sleeve located near the connector.

		Shipped On Vector Pro Generation			Signal	Description (alternate signal) 3
		1 st	2 nd , 3 rd	2 nd , 3 rd		
15 m		051-0063-003	051-0063-004	051-0157-002		
	30 m		051-0098-001	051-0158-001		
re four	Red 1	Red 1	Red 1	n/a	n/a	Power Input
	Black 1	Black 1	Black 1	n/a	n/a	Power Ground
	Blue	Blue	Blue	RS-232, Tx		Port A Transmit
	Black	Blue, White stripe	Black, Blue stripe	RS-232, Rx		Port A Receive
	Green	Green	Green	RS-422, 'B'		Port A Transmit
	Black	Green, White stripe	Black, Green stripe	RS-422, 'A'		
	Brown	Brown	Brown	RS-232, Tx		Port B Transmit (Secondary Port A Tx)
	Black	Brown, White stripe	Black, Brown stripe	RS-232, Rx		Port B Receive (Secondary Port A Rx)
	Black	White, Black stripe	Grey	RS-232, Gnd		Signal Ground
	Yellow	Yellow	Yellow	RS-422, 'B'		Port B Transmit (Secondary Port A Tx)
	Black	Yellow, Black stripe	Yellow, Black stripe	RS-422, 'A'		
	Orange	Orange	n/a	HCMOS, 'B'		1 pulse/second timing output
	Black	Orange, White stripe	n/a	HCMOS, 'A'		
	White	White	n/a	n/a (RS-232, Tx)		Not connected (Port B Tx)
	n/a	n/a	White	n/a		Alarm Output Pin 1
n/a n/a		White, Red stripe	n/a		Alarm Output Pin 2	
Bare Wire	Bare Wire	Bare Wire 2	n/a		Drain for RF Shielding !! DO NOT CONNECT !!	

Table 26 – Colour Coding of All Standard Cables

- The Power Input & Ground (Red, Black) wires are 18 AWG; all the other insulated wires are 24 AWG.
- The Drain wire on the 2nd/3rd generation's 30m cable is insulated with black heat-shrink.
- Some of the signal descriptions apply only to the 2nd & 3rd generations; the alternate signal listed in parentheses in those cases is for the first-generation only. The RS-232 Port B on the 1st generation only had the Tx signal. The RS-232 Secondary Port A was useable only for special purposes.

Cable Usage

For the 15 metre cable supplied on the first-generation G2s (marking 051-0063-003), there are several black coloured signal wires, each carrying a different signal – which can be very confusing.

To help prevent wiring errors caused by “many black wires”, all the wires in this cable are twisted in pairs, with each black wire paired with its respective non-black coloured counterpart. Each pair is also held together by a short piece of tubing, just after they exit from the cable’s overall jacket.

Caution! If you must cut type 051-0063-003, be sure to maintain the signal wire pairings.

For all the other cable types, the second colour listed in the table below is either repeated bands of the colour, or a thin spiralling stripe of that colour. The wires are twisted in pairs (but without any pair-retaining tubing).

Caution! The coloured “stripe” is either repeated bands of the colour, or a thin spiralling stripe. The stripe can be very hard to see (especially the Blue, Green & Brown stripes, all on Black backgrounds); please inspect the wires carefully, under a good light, to be sure you are using the right wires!

Note: the Installation chapter’s Colour Code information (Table 2, and Figure 12, Figure 14 & Figure 15) shows only the colour codes of the cable types currently supplied with the Vector Pro (cable type numbers 051-0157-002 & 051-0158-0001 – see the 3rd column in Table 26 above).

For the earlier cable types, listed in the 1st & 2nd columns of Table 26, please use the colours in either the 1st or 2nd column (whichever applies) that match the signals you are using, instead of the colours shown in the Installation chapter.

All cables can potentially be used on all generations of the Vector Pro G2.

Note: because there are differences – with respect to the output data signals – between the first and subsequent generations of the Vector Pro, the signals available on the cable depend on both the cable type and the Vector Pro’s generation.

 **If the older cable types are used with third-generation Vector Pro G2 & G2Bs, the Alarm output is not provided; because of this, such use may not be approved by some Standards organizations!**

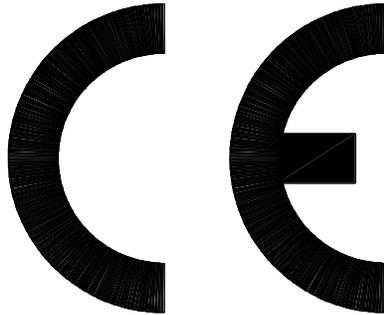
CE COMPLIANCE

This product is in compliance with the Electro-Magnetic Compatibility (EMC) standards of the European Community, and therefore bears the CE-marking, per EMC Directive 2004/108/EC

It has been tested according to the applicable sections outlined under:

Technical Standard IEC 60945 ed. 4, Marine Navigation and Radiocommunication Equipment and Systems

Applicable sections for methods of testing and required test results are:

Report Section	Test Type	Specification	Performance Criterion	Basic Standard	Result
§ 3.1	Conducted Emissions	IEC 60945 ed.4 § 9.2	A CISPR	16-1 PASS	
§ 3.2	Radiated Emissions	IEC 60945 ed.4 § 9.3	A CISPR	16-1 PASS	
§ 3.3	Conducted RF disturbance	IEC 60945 ed.4 § 10.3	A IEC	61000-4-6	PASS
§ 3.4	Radiated Radio frequencies	IEC 60945 ed.4 § 10.4	A IEC	61000-4-3	PASS
§ 3.5	Fast Transients	IEC 60945 ed.4 § 10.5	B IEC	61000-4-4	PASS
§ 3.6	Reverse Polarity	IEC 60945 ed.4 § 5.2.3	B - PASS		
§ 3.7	Excessive Power Supply Conditions	IEC 60945 ed.4 § 4.3.2 (7.2) per § 5.2.3	B - PASS		
§ 3.8	Surges On AC Power Lines	IEC 60945 ed.4 § 10.6	B IEC	61000-4-5 N/A	
§ 3.9	Power Supply Short-Term Variation	IEC 60945 ed.4 § 4.3.3 (7.3) per § 10.7	B -	PASS	
§ 3.10	Power Supply Failure	IEC 60945 ed.4 § 4.3.3 (7.4) per § 10.8	C -	PASS	
§ 3.11	ESD – Direct	IEC 60945 ed.4 § 10.9	B IEC	61000-4-2	PASS
§ 3.12	ESD – Indirect	IEC 60945 ed.4 § 10.9	B IEC	61000-4-2	PASS

Complete test results and a declaration of CE conformity are on file at:

Manufacturer Seller
Hemisphere GPS LLC (formerly CSI Wireless)
4110 – 9th Street S.E.
Calgary, Alberta
Canada T2G 3C4

SI-TEX Marine Ltd.
#15 - 13511 Crestwood Place
Richmond, BC
Canada V6V 2G1

Compass Safe Distance Certificate



BUNDESAMT FÜR SEESCHIFFFAHRT UND HYDROGRAPHIE
 FEDERAL MARITIME AND HYDROGRAPHIC AGENCY

Bescheinigung Nr. 522
 Certificate No.

BUNDESAMT FÜR SEESCHIFFFAHRT UND HYDROGRAPHIE

über die Messung der Schutzabstände vom Magnet-Regel- und Magnet-Steuerkompaß gemäß ISO R 694 und DIN EN 60945 Absatz 11.2
 (about the measurement of the safe distances to the Standard-Magnetic- and Steering-Magnetic-compass in accordance with ISO R 694 and IEC 60945 Section 11.2)

Steuerkursstransmitter (GNSS-Methode) MV 110

Gerät bzw. Anlageteil <i>Equipment or part of equipment</i>	Steuerkursstransmitter <i>Transmitting heading device</i>	
Hersteller <i>Manufacturer</i>	CSI Wireless Inc., Canada	
Nr. der Baumusterprüfbescheinigung <i>No. of type approval certificate</i>	- - -	
Typbezeichnung <i>Type</i>	MV 110	
Serien – Nr. <i>Part – No.</i>	804-0037-x0A / 328557/2006	
Schutzabstand vom <i>Safe distance to the</i> Magnet-Regelkompaß <i>Standard-Magnetic-compass</i> Magnet-Steuerkompaß <i>Steering-Magnetic-compass</i>	1,25 m 0,80 m	
Reduzierter Schutzabstand vom <i>Reduced safe distance to the</i> Magnet-Regelkompaß <i>Standard-Magnetic-compass</i> Magnet-Steuerkompaß <i>Steering-Magnetic-compass</i>	0,75 m 0,50 m	
Bemerkungen <i>Remarks</i>	o.a. Werte gelten auch für die Version MV 100 <i>the values quoted above apply also to the version MV 100</i>	

Gerät bzw. Anlageteil <i>Equipment or part of equipment</i>				
Hersteller <i>Manufacturer</i>				
Nr. der Baumusterprüfbescheinigung <i>No. of the type approval certificate</i>				
Typbezeichnung <i>Type</i>				
Einzelnummer <i>Part number</i>				
Schutzabstand vom <i>Safe distance to the</i> Magnet-Regelkompaß <i>Standard-Magnetic-compass</i> Magnet-Steuerkompaß <i>Steering-Magnetic-compass</i>				
Reduzierter Schutzabstand vom <i>Reduced safe distance to the</i> Magnet-Regelkompaß <i>Standard-Magnetic-compass</i> Magnet-Steuerkompaß <i>Steering-Magnetic-compass</i>				
Bemerkungen <i>Remarks</i>				

Die gemessenen Schutzabstände gelten ausschließlich für die vorgestellte Ausführung. Bei Änderung der Konstruktion und / oder der Betriebsdaten verliert die Bescheinigung ihre Gültigkeit.

The measured safe distances apply only to the represented design. If the construction and / or operating data are changed this certificate will lose its validity.

Hamburg, den 26. Juni 2007

Im Auftrag
By order

Stahlke

Warranty Information

Limited Warranty

This Limited Warranty (the "Warranty") covers all Vector Pro and Navigator GPS Compass products & accessories (the "Equipment") sold by SI-TEX Marine Ltd. ("SI-TEX").

LIMITED ONE YEAR WARRANTY

SI-TEX warrants to the Purchaser, provided that the recommended installation and maintenance procedures set forth in the manual (the "Manual") that has been provided with the Equipment have been followed, and subject always to the other provisions of this Warranty, that the Equipment is free from defects in workmanship and materials under normal use and service for a period of one (1) year from the date of purchase of the Equipment by the Purchaser.

EXCLUSIONS

This Limited Warranty is null and void if:

1. The serial number of the Equipment has been removed, altered or mutilated;
2. Any of the anti-tamper seals covering case-screw holes, or other mechanisms for opening the Equipment's case, have been removed, broken or otherwise tampered with;
3. There are any defects in it, or damages to it, caused by:
 - a. Faulty installation or hook-up of the Equipment;
 - b. Abuse, misuse, or any use of the Equipment in violation of the instructions set forth in the Manual;
 - c. Shipping, alterations, or incorrect and/or unauthorized service;
 - d. Accident, exposure of the Equipment to excessive heat, fire, lightning or other electrical discharge, or water immersion;
 - e. Water damage due to failure to fully fasten the plug connected into the Equipment's power/signal receptacle;
 - f. Improper or inadequate ancillary or connected equipment.

OTHER LIMITATIONS AND EXCLUSIONS

1. SI-TEX does not warrant or guarantee the precision or accuracy of positions, heading, or other GPS-based navigation data obtained when using the Equipment. The potential accuracy of the Equipment, as stated in the Manual, associated SI-TEX literature and/or Product specifications, provides only an estimate of the highest achievable accuracy based on:
 - a. Specifications provided by the US Department of Defence for GPS Positioning;
 - b. GPS Receiver specifications provided by the OEM manufacturer;
 - c. DGPS service provider performance specifications.
2. The Equipment is not intended for primary navigation or for use in safety of life applications; SI-TEX does not warrant or guarantee that the Equipment will perform in accordance with the requirements of such usage;
3. SI-TEX reserves the right to modify the Equipment without any obligation to notify, supply or install any improvements or alterations to existing Equipment.

NO OTHER WARRANTIES

THE FOREGOING WARRANTY IS EXCLUSIVE OF ALL OTHER WARRANTIES AND CONDITIONS, WHETHER WRITTEN, ORAL OR IMPLIED, ARISING BY STATUTE OR OTHERWISE, WITH RESPECT TO THE DESIGN, SALE, INSTALLATION OR USE OF THE EQUIPMENT, INCLUDING BUT NOT LIMITED TO IMPLIED WARRANTIES OR CONDITIONS OF MERCHANTABILITY AND FITNESS FOR THE ORDINARY PURPOSES FOR WHICH THE EQUIPMENT IS USED OR FITNESS FOR A PARTICULAR PURPOSE, AND ANY OTHER OBLIGATIONS ON THE PART OF SI-TEX, ITS EMPLOYEES, SUPPLIERS, AGENTS, OR REPRESENTATIVES.

LIMITATION OF LIABILITY

The extent of SI-TEX's liability for damages of any nature to the end purchaser or any other person or entity whether in contract or tort, and whether to persons or property, shall in no case exceed, in the aggregate, the cost of correcting the defect in the equipment or, at SI-TEX's option, the cost of replacing the defective item. In no event will SI-TEX be liable for any loss of production, loss of profits, loss of use or for any special, indirect, incidental, consequential or contingent damages, even if SI-TEX has been advised of the possibility of such damages. Without limiting the foregoing, SI-TEX shall not be liable for any damages of any kind resulting from installation, use, quality, performance or accuracy of the equipment.

NOTICE OF DEFECT

The Limited Warranty will not apply with respect to any defective Equipment unless written notice of such defect is given to SI-TEX, by mail to the address for SI-TEX set forth below, or by facsimile to SI-TEX at 604-207-8008, and unless that written notice is received by SI-TEX within ten (10) days of the date upon which the defect first became known to the Purchaser.

Notices sent by mail from within North America will be deemed to be received by SI-TEX on the seventh (7th) day first following the date of posting. Notices sent by mail from anywhere else in the world will be deemed to be received by SI-TEX on the tenth (10th) day next following the date of posting. Notices sent by facsimile will be deemed to be received by SI-TEX on the date of transmission with appropriate answerback confirmation.

REMEDIES NOT TRANSFERABLE

The Purchaser's remedies under this Warranty apply only to the original end-user of the SI-TEX Equipment, being the Purchaser, and apply only to the original installation of the Equipment. The Purchaser's remedies under this Warranty are not transferable or assignable by the Purchaser to others in whole or in part.

CUSTOMER REMEDIES

1. If the Equipment, or any part thereof, proves to be defective within the warranty period, the Purchaser shall do the following:
 - a. contact SI-TEX, by phoning 604-207-1600, to discuss the nature of the problem and to obtain return shipping instructions for the defective Equipment;and,
 - b. prepare a detailed written statement of the nature and circumstances of the defect, to the best of the Purchaser's knowledge, and including the date of purchase of the Equipment, the place of purchase, the name and address of the installer, and the Purchaser's name, address and telephone number, all to be sent, along with proof of purchase, to SI-TEX at the address set out below, and within the time limits set out above for Notice of Defect.

2. If, upon examination by SI-TEX, the defect is determined to result from defective workmanship or material and if the defect has occurred within the warranty period set forth above, the Equipment or the defective parts thereof shall be repaired or replaced, at SI-TEX's sole option, without charge, and shall be returned to the Purchaser at SI-TEX's expense. Return delivery will be by the most economical means. Should the Purchaser require that the Equipment be returned by a faster method, the costs incurred by the faster delivery will be pre-paid by the Purchaser.
3. No refund of the purchase price for the Equipment will be made to the Purchaser unless SI-TEX is unable to remedy the defect after having a reasonable number of opportunities to do so.
4. Warranty service shall be performed only by SI-TEX. Any attempts to remedy the defect by anyone else shall render the warranties set forth in this Warranty null and void.

CHOICE OF LAW AND JURISDICTION

This Warranty is governed by the laws of the Province of British Columbia, Canada. If the Purchaser acquired the Equipment outside of Canada, each of the parties hereto irrevocably attorn to the jurisdiction of the courts of the Province of British Columbia, Canada, and further agree to settle any dispute, controversy or claim arising out of or relating to this Limited Warranty, or the breach, termination, or invalidity of it, by arbitration under the rules of the British Columbia International Commercial Arbitration Centre ("BCICAC"). The appointing authority shall be BCICAC [or, if the BCICAC shall cease to exist, the Chief Justice of the Supreme Court of British Columbia]. BCICAC shall administer the case in accordance with BCICAC Rules. There shall be one arbitrator and the place of arbitration shall be Vancouver, British Columbia, Canada.

The United Nations Convention on Contracts for the International Sale of Goods Act, S.B.C 1990, c. 20, and any other statutory enactments of the United Nations Convention on Contracts for the International Sale of Goods do not apply to this Warranty.

SI-TEX Maine Ltd.
#15 - 13511 Crestwood Place
Richmond, British Columbia
Canada, V6V 2G1

WARNING

The Equipment is an aid to navigation only. It is not intended or designed to replace the person on watch. A qualified person should always be in a position to monitor the vessel's heading, and to watch for navigational hazards, and should be prepared to revert to manual steering immediately if an undesired change of heading occurs, if the heading is not maintained within reasonable limits, or when navigating in a hazardous situation.

ALWAYS REMEMBER:

WHENEVER UNDER WAY, A QUALIFIED PERSON ON WATCH IS REQUIRED BY LAW.

Index

Index

– A –

Acquisition Time.....39
 Alignment2, 20, 22, 25, 41, 58, 107

– B –

Baud rate..2, 29, 36, 45, 48, 49, 51, 54, 55, 56, 61,
 72, 83, 90
 Beacon3, 18, 28, 41, 47, 53, 55, 61, 69, 75, 82,
 83, 90
 Binary47, 51, 53, 57, 90

– C –

Care & Maintenance63, 65
 Checks65
 COM port.....29, 32, 33, 36, 49, 50, 72, 73, 75
 Command.....52, 53, 54, 55, 56, 80, 84
 SI-TEX autopilot.....2, 30, 45, 48, 90
 configuration...2, 14, 20, 28, 29, 30, 34, 39, 41, 45,
 46, 47, 48, 49, 51, 56, 58, 81, 89

– D –

DGPS 2, 14, 18, 29, 39, 40, 41, 42, 55, 61, 69, 82,
 83, 84, 89, 90, 97

– F –

Fuse Replacement.....65

– G –

G2B . 1, 2, 3, 14, 18, 27, 40, 41, 47, 53, 55, 61, 65,
 69, 75, 82, 83, 89, 90, 91, 107
 GPS Reception18
 Ground ... 17, 27, 28, 29, 33, 36, 42, 46, 54, 60, 91

– H –

HyperTerminal2, 49, 61, 71, 73, 74, 75, 77, 78, 80,
 83

– I –

Installation..... 1, 15, 17, 19, 20, 30, 36, 50, 89, 92

– N –

Navigator G2..... 26, 28, 30, 34, 49, 50, 61
 NMEA26, 28, 29, 30, 34, 36, 46, 47, 48, 49, 51,
 52, 55, 61, 70, 83, 90

– P –

PC 2, 28, 29, 32, 33, 34, 35, 36, 39, 45, 47, 49, 50,
 71, 74, 75, 80, 82
 Pitch..... 2, 19, 43, 44, 47, 54, 55, 60
 PocketMAX..... 34, 49, 50, 61
 Power Supply..... 17, 93
 Proprietary 47, 51, 52, 53, 55

– R –

Roll..... 2, 20, 41, 43, 44, 47, 54, 58, 60, 84
 RS-232...26, 27, 28, 29, 30, 32, 33, 34, 36, 40, 48,
 49, 51, 70, 71, 90, 91
 RS-422...26, 27, 28, 29, 30, 32, 34, 36, 48, 70, 90,
 91
 RTK..... 42, 43, 44, 47, 56, 58, 59

– S –

Specifications..... 17, 69, 70, 97

– U –

USB 32, 33, 36, 71, 75

– W –

Warranty 1, 17, 22, 24, 25, 97, 98, 99
 Wiring..... 2, 26, 30, 31, 34, 35

User Notes

User Notes & Settings

User Settings

Once your Vector Pro G2 has been installed and configured correctly, you can make a record of all the settings you have chosen, in the tables below.

Sentences	Range	Port A		Port B	
		Default	Yours	Default	Yours
GPDTM	0, 0.2, 1, 5 or 10	0		0	
GPGGA	0, 0.2, 1, 5 or 10	1		0	
GPGLL	0, 0.2, 1, 5, 10 or 20	1		0	
GPGNS	0, 0.2, 1, 5 or 10	0		0	
GPGRS	0, 0.2, 1, 5 or 10	0		0	
GPGSA	0 or 1	0.2		0	
GPGST	0 or 1	0.2		0	
GPGSV	0 or 1	0.2		0	
GPHDG	0, 0.2, 1, 5, 10 or 20	1		0	
GPHDM	0, 0.2, 1, 5, 10 or 20	1		10	
GPHDT	0, 0.2, 1, 5, 10 or 20	1		10	
GPRMC	0, 0.2, 1, 5 or 10	0.2		0	
GPROT	0, 0.2, 1, 5 or 10	1		0	
GPRRE	0 or 1	0		0	
GPVTG	0, 0.2, 1, 5 or 10	1		1	
GPZDA	0, 0.2, 1, 5 or 10	1		0	
PCSI,CS0	0 or 1	0		0	
PCSI,CS1	0, 0.2, 1, 5 or 10	0		0	
PSAT,GBS	0, 0.2, 1, 5 or 10	0		0	
PSAT,HPR	0 or 1	1		0	
PSAT,INTLT	0 or 1	0		0	
RD1	0 or 1	0		0	
BAUD rate	4800, 9600, 19200, 38400	4800		4800	

Table 27 – User Settings (Ports)

Parameter	Range	Default	Yours
Alignment	Fore-Aft or Athwartships	Fore-Aft	
ROLL	NO, YES	NO	
HBIAS	-180.0° to 180.0°	0.0	
PBIAS	-15.0° to 15.0°	0.0	
DIFF	NONE, WAAS, EXTERNAL (G2B: also BEACON)	G2	NONE
		G2B BEACON	
GYROAID	NO, YES	YES	
TILTAID	NO, YES	YES	
NMEAHE	0, 1	0	
COGTAU	0.0 to 200.0	0.0	
HTAU	0.0 to 3600.0	2.0	
HRTAU	0.0 to 3600.0	2.0	
PTAU	0.0 to 3600.0	0.5	
SPDTAU	0.0 to 200.0	0.0	
SMOOTH	SHORT, LONG, 15 to 6000	900	

Table 28 – User Settings (Alignment & Operational)

