

Gauge Installation:

1. Select the desired mounting location of the instrument.
2. Depending on your mounting configuration, it might be necessary to program the gauge before installation.
3. Mount the gauge and secure with the included hardware. Tighten mounting nuts using 7mm or 9/32 wrench to 7inch lbs (finger tight plus ¼ turn).

Wiring the Gauge:

1. Route wires from the instrument to
 - (a) Battery (+) switched power after the fuse box or user supplied in line fuse (5 amp, fast blow) to terminal "BAT"
 - (b) Light switch after the fuse box, or user supplied in line fuse (1 amp) and switch to light bulbs
 - (c) Ground location not shared with other electronics (such as battery negative terminal or direct to chassis) to terminal "GND" and light bulbs.
 - (d) Route the signal wire from the gauge (S/G) to the signal wire source location. This will be where the tachometer receives its signal from.

Terminal	Description
BAT	Switched power (12v)
S/G	Tachometer signal input
GND	Ground

Read these instructions thoroughly before installation. Do not deviate from assembly or wiring diagram. Always disconnect battery ground before making any electrical connections.

Parts List		
Item	Description	Qty
1	52mm Gauge	1
2	Clamp and hardware	1
3	Instruction Sheet	1

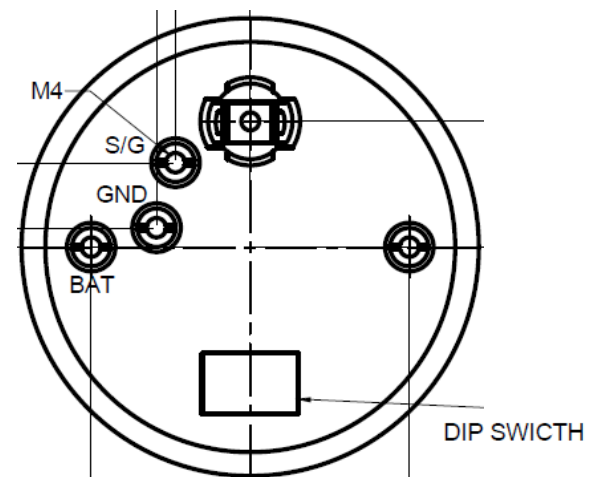

Reference A (drawing not to scale)

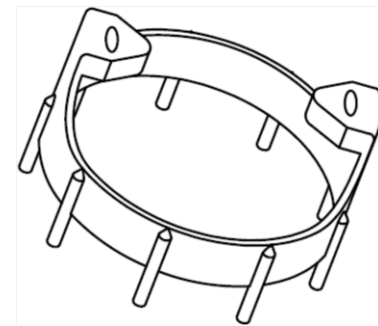

Merchandise warranted against defects in factory workmanship and materials for a period of 24 months after purchase. This warranty applies to the first retail purchaser and covers only those products exposed to normal use or service. Provisions of this warranty shall not apply to a VDO product used for a purpose for which it is not designed, or which has been altered in any way that would be detrimental to the performance or life of the products, or misapplication, misuse, negligence or accident. On any VDO part or VDO product found to be defective after examination by manufacturer, manufacturer will only repair or replace the merchandise through the original selling dealer. Manufacturer assumes no responsibility for diagnosis, removal and/or installation labor, loss of vehicle use, loss of time, inconvenience or any other consequential expenses. The warranties herein are in lieu of any other expressed or implied warranties, including any implied warranty or merchantability of fitness, and any other obligation on the part of manufacturer, or selling dealer.

Allentare Tachometer 85mm

Tech Support 1-800-265-1818
<http://usa.vdo.com>

Instruction Sheet # A2C59506767

Rev 06-2015

Programming the Gauge:

The picture below shows the settings for the dip switches on/off

Dip switches located on back of gauge

1	2	3	4	5	6
On	On	On	On	On	On
Off	Off	Off	Off	Off	Off

For Inboard/Sterndrive Gas Engines

4 cylinder #1 on, all others off

6 cylinder #2 on, all others off

8 cylinder #3 on, all others off

For Outboard Engines with Tachometer Pickup off Flywheel

Reference the chart on next page to find your outboard engine

4 poles #1 on, all others off

6 poles #2 on, all others off

8 poles #3 on, all others off

10 poles #4 on, all others off

12 poles #5 on, all others off

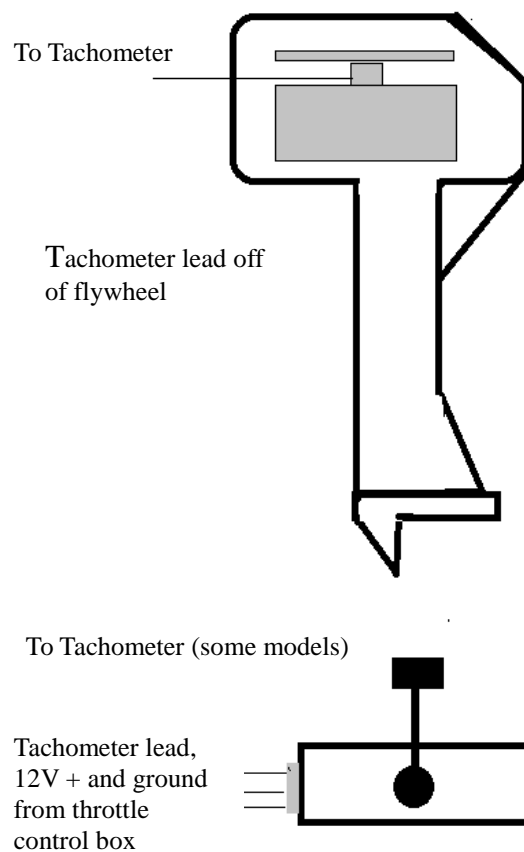
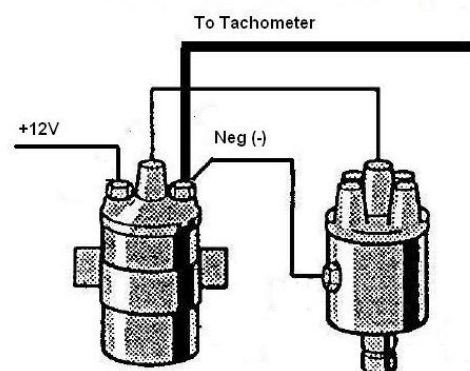

Allentare Tachometer 85mm

Tech Support 1-800-265-1818
<http://usa.vdo.com>

Instruction Sheet # A2C59506767

Rev 06-2015

Analog Tachometer Signals for Outboard Engines				
MAKE	YEAR	MODEL	ALTERNATOR # OF POLES	DIP SWITCH TO "ON"
Chrysler	1988-83	All	12	5
	Except	55hp/80hp	20	NA
Evinrude/Johnson	Up to 2008	All V Models 3 Cylinder Engines	12	5
	Except 1996-2004	2 cylinder 9.9-35hp	10	4
	Except 1977-1991	2 cylinder 4-35hp	10	4
	Except 2005 & newer	2 cylinder 4-35hp	10	4
	Except 1971-1976	2 cylinders 40-80hp	10	4
	Except 2001 or newer	9.9-15hp 4 stroke	6	3
Force	1984-1999	All	12	5
	Except 1987 & older	50hp (A,B models)	8	3
	Except 1994 & older		20	NA
Honda	2008 and older		4	1
	2005 & older	BF35/ 45 BF40/50	6	2
		BF 8D/9.9D BF 15D/20D including power thrust models	12	5
<small>NOTE: 2005 & older flter models require Honda harness 92197-ZH5-003 2006 & older 40/50HP before require 06389-ZV6-316 tach kit</small>				
Mercury/Mariner	1977-2008	All	12	5
	Except 1999 & older	8,9.9 hp	6	2
	Except 2002 & newer	8 & 9.9 hp	6	2
		All 50 hp 4 stroke	6	2
	Except 1999 & newer	6-25 hp	10	4
	Except 2002 & up	6-25 hp (requires adapter 17461A9or 17461T1)	10	4
	Except 1983 & older	18,25,48,60hp Mariner	4	1
	Except 1998-2004	8,9.9,15,25hp (4 stroke)	4	1
	Except 1999 - older	40hp (up to serial number 582399)	4	1
<small>NOTE: 75,90,118hp 4 stroke EFI require Mercury tach adapter 17461A9 or A10 or (service p/n 66-503040A1)</small>				
Suzuki	2008 and older	All	12	5
	Except	55 hp	4	1
	Except 1985 & older	60,65hp	4	1
	Except	50,60hp Cabrea	4	1
	Except	DF4-30hp (4 stroke)	6	2
	Except 1993 & newer	25-30hp	6	2
	Except 1985 & older	65hp	6	2
Tohatsu/Nissan	2008 & older	All	4	1
	Except	2 stroke N40D,40D2,50D, 50D, 70B, 70C	6	2
	Except	All 3 cylinders	6	2
	Except	2 stroke/ 4 cylinder 115,120,140hp	12	5
	Except	4 stroke 8-30hp & EFI 25-30hp	12	5
<small>NOTE: TLDI engines require use of Indictation light kit 319762610 & harness 316710420 purchased through the engine dealer</small>				
Yamaha	1984-2008	All	6	2
	Except 1984-87	6-25hp 2 cylinder	4	1
	Except 1985-91	FT9.9	4	1
	Except	C25-C55 2 cylinder	4	1
	Except 1993-97	C30 2 cylinder	4	1
	Except	FT25-F250,	12	5
	Except	HPD1 150-300	12	5
	Except	80SX250	12	5
	Except	F/T 9.9 (early92)	12	5
	Except	C75-150	12	5
	Except	F75-F200	12	5
	Except	VV150-250 & F15C/F20	12	5