

LINK UP GATEWAYS SERIES

LINK UP J1939

OPERATING INSTRUCTIONS
rev. AA



CONTENT

Introduction	3
Safety information	4
System installation	6
Configuration	9
Technical data	14

INTRODUCTION

SYSTEM COMPONENTS



1x Link Up gateway (B000424)

This device will translate all your engine data, which is transmitted on a CAN-J1939-Bus, to the NMEA2000® standard, making all the information available for any display. Wireless configurable, the Link Up gateway can be easily set up with your smartphone and the Link Up configurator App.

THE LINK UP GATEWAY CONCEPT

The Link Up J1939 (hereinafter “Device” or “Link Up”) provides an easy method to convert engine or vessel information to NMEA 2000.

Easily installed, the LinkUp gateway replaces the original wiring by a single NMEA2000 drop cable.

The data are then available for being displayed on any OceanLink, AcquaLink, or more in general on any glass cockpit NMEA 2000 display device.

Configuring LinkUp gateways is simple using a mobile device and the companion LinkUp Configurator App for Android or iOS.

Each device has a built-in, passive NFC antenna, so the parameters of the engine, such as engine instances or the alarm settings, are wirelessly configured on the mobile device which is then “tapped” against the LinkUp device for instant data download.

DESIGN AND FUNCTION

The Link Up gateway has a simple but yet effective design.

The potted housing allows the unit to be installed in Engine Rooms, making it compliant to the ISO 8846:1990 as requested by the directive 2013-53(EC).

The standard NMEA 2000® M12 plug allows for a plug-and-play installation to the network backbone.

The CAN J1939 connection happens through a Deutsch DT04-6P 6-pole connector

SAFETY INFORMATION



WARNING

- No smoking! No open fire or heat sources!
-
- The product was developed, manufactured and inspected according to the basic safety requirements of EC Guidelines and state-of-the-art technology.
 - The instrument is designed for use in grounded vehicles and machines as well as in pleasure boats, including non-classified commercial shipping.
 - Use our product only as intended. Use of the product for reasons other than its intended use may lead to personal injury, property damage or environmental damage. Before installation, check the vehicle documentation for vehicle type and any possible special features!
 - Use the assembly plan to learn the location of the fuel/hydraulic/compressed air and electrical lines!
 - Note possible modifications to the vehicle, which must be considered during installation!
 - To prevent personal injury, property damage or environmental damage, basic knowledge of motor vehicle/shipbuilding electronics and mechanics is required.
 - Make sure that the engine cannot start unintentionally during installation!
 - Modifications or manipulations to veratron products can affect safety. Consequently, you may not modify or manipulate the product!
 - When removing/installing seats, covers, etc., ensure that lines are not damaged and plug-in connections are not loosened!
 - Note all data from other installed instruments with volatile electronic memories.

SAFETY DURING INSTALLATION

- During installation, ensure that the product's components do not affect or limit vehicle functions. Avoid damaging these components!
- Only install undamaged parts in a vehicle!
- During installation, ensure that the product does not impair the field of vision and that it cannot impact the driver's or passenger's head!
- A specialized technician should install the product. If you install the product yourself, wear appropriate work clothing. Do not wear loose clothing, as it may get caught in moving parts. Protect long hair with a hair net.
- When working on the on-board electronics, do not wear metallic or conductive jewelry such as necklaces, bracelets, rings, etc.
- If work on a running engine is required, exercise extreme caution. Wear only appropriate work clothing as you are at risk of personal injury, resulting from being crushed or burned.
- Before beginning, disconnect the negative terminal on the battery, otherwise you risk a short circuit. If the vehicle is supplied by auxiliary batteries, you must also disconnect the negative terminals on these batteries! Short circuits can cause fires, battery explosions and damages to other electronic systems. Please note that when you disconnect the battery, all volatile electronic memories lose their input values and must be reprogrammed.
- If working on gasoline boat motors, let the motor compartment fan run before beginning work.
- Pay attention to how lines and cable harnesses are laid so that you do not drill or saw through them!
- Do not install the product in the mechanical and electrical airbag area!
- Do not drill holes or ports in load-bearing or stabilizing stays or tie bars!

SAFETY INFORMATION

- When working underneath the vehicle, secure it according to the specifications from the vehicle manufacturer.
- Drill small ports; enlarge and complete them, if necessary, using taper milling tools, saber saws, keyhole saws or files. Deburr edges. Follow the safety instructions of the tool manufacturer.
- Use only insulated tools, if work is necessary on live parts.
- Use only the multimeter or diode test lamps provided, to measure voltages and currents in the

vehicle/machine or boat. Use of conventional test lamps can cause damage to control units or other electronic systems.

- The electrical indicator outputs and cables connected to them must be protected from direct contact and damage. The cables in use must have enough insulation and electric strength and the contact points must be safe from touch.
- Use appropriate measures to also protect the electrically conductive parts on the connected consumer from direct contact. Laying metallic, uninsulated cables and contacts is prohibited.

SAFETY AFTER INSTALLATION

- Connect the ground cable tightly to the negative terminal of the battery.
- Reenter/reprogram the volatile electronic memory values.

- Check all functions.
- Use only clean water to clean the components. Note the Ingress Protection (IP) ratings (IEC 60529).

ELECTRICAL CONNECTION

- Note cable cross-sectional area!
- Reducing the cable cross-sectional area leads to higher current density, which can cause the cable cross-sectional area in question to heat up!
- When installing electrical cables, use the provided cable ducts and harnesses; however, do not run cables parallel to ignition cables or to cables that lead to large electricity consumers.
- Fasten cables with cable ties or adhesive tape. Do not run cables over moving parts. Do not attach cables to the steering column!
- Ensure that cables are not subject to tensile, compressive or shearing forces.
- If cables are run through drill holes, protect them using rubber sleeves or the like.
- Use only one cable stripper to strip the cable. Adjust the stripper so that stranded wires are not damaged or separated.
- Use only a soft soldering process or commercially available crimp connector to solder new cable connections!

- Make crimp connections with cable crimping pliers only. Follow the safety instructions of the tool manufacturer.
- Insulate exposed stranded wires to prevent short circuits.
- Caution: Risk of short circuit if junctions are faulty or cables are damaged.
- Short circuits in the vehicle network can cause fires, battery explosions and damages to other electronic systems. Consequently, all power supply cable connections must be provided with weldable connectors and be sufficiently insulated.
- Ensure ground connections are sound.
- Faulty connections can cause short circuits. Only connect cables according to the electrical wiring diagram.
- If operating the instrument on power supply units, note that the power supply unit must be stabilized and it must comply with the following standard: DIN EN 61000, Parts 6-1 to 6-4

SYSTEM INSTALLATION

WARNING

Before beginning, disconnect the negative terminal on the battery, otherwise you risk a short circuit. If the vehicle is supplied by auxiliary batteries, you must also disconnect the negative terminals on these batteries! Short circuits can cause fires, battery explosions and damages to other electronic systems. Please note that when you disconnect the battery, all volatile electronic memories lose their input values and must be reprogrammed.

BEFORE THE ASSEMBLY

1. Before beginning, turn off the ignition and remove the ignition key. If necessary, remove the main circuit switch

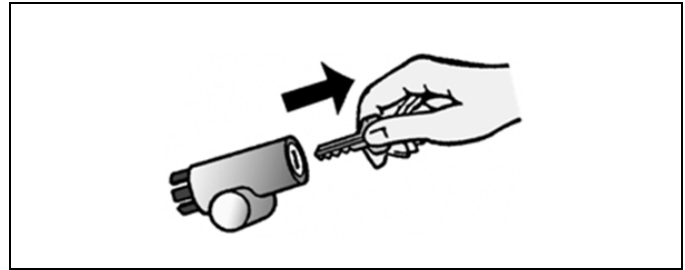

2. Disconnect the negative terminal on the battery. Make sure the battery cannot unintentionally restart.

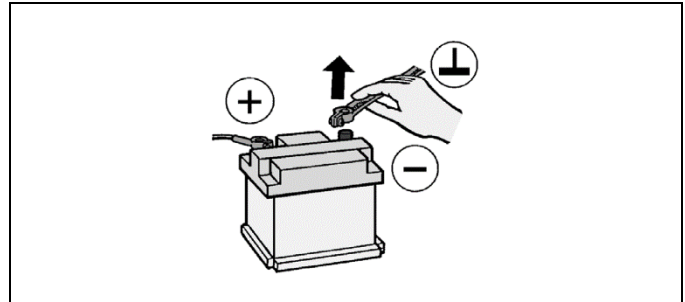

3. Place the device at least 500 mm away from any magnetic compass.

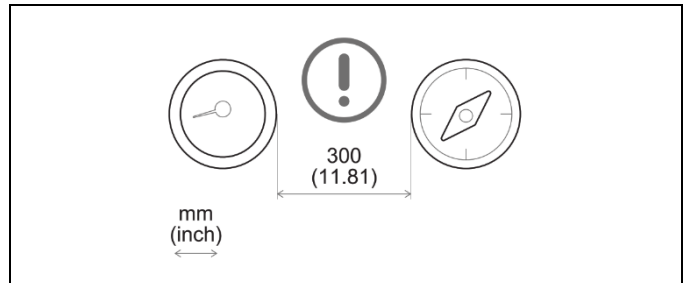

CONNECT TO THE J1939 NETWORK

SAE J1939 is a common CAN bus standard. CAN buses are used to connect the different sensors, monitors and other electrical components of a machine, and digitally transmit the required data in between those components.

The J1939 CAN bus works on a speed of 250 kbps. The physical layer consists of four wires. Next to the two power lines (VCC and Ground) there are two wires used for the data transmission called "CAN High" and "CAN Low".

Before you start with the installation of the Link Up, we strongly recommend to check the engine connector wiring in the engine's manual and verifying your engine connector wiring with a simple multimeter to ensure you whether you have the right connector.

- Turn off the circuit breaker and check the resistance between the CAN High and CAN Low pins. The value should lay somewhere between 60 and 120 Ohm.

- Turn on the circuit breaker (for some models the ignition also should be on) and measure the voltage between the two Powerlines (GND and VCC). It must be 12 to 24 Volts.

If possible, use the provided plug (shown in figure 2) to connect the Link Up Gateway to your vessel. The contacts must audibly lock into place.

If the vessels engine is not equipped with the matching connector, it is possible to either crimp a female counterpart on it (see "Technical Data"), or simply cut-off the plug on the Link Up and manually connect the wires. For this, refer to the pinout description, provided in the section "Technical Data".



Plug for connection from Link Up to CAN 1939-Bus (Deutsch DT04-6P)

CONNECT TO THE NMEA 2000® NETWORK

Once the Link Up Gateway is mounted complete, it is possible to interface it to the NMEA 2000® backbone through the dedicated plug.

Please ensure to tighten the M12 connector by screwing it onto its counterpart, so to preserve the water tightness.

A drop cable is not needed unless the total length of the Link Up device is not enough to reach the NMEA 2000® backbone. In this case it is possible to extend the total length by using one of the accessory drop cables.

Please note that NMEA 2000® does not allow drop cables longer than 6 meters.

Refer to the NMEA 2000® standard for a proper network design.

If power from the NMEA 2000® network is received, the green LED on the Link Up housing will start flashing (see "LED notifications").



CONFIGURATION

LINK UP CONFIGURATOR APP

To configure your system, some parameters must be calibrated through the Link Up gateway. These parameters are:

- number of engines, which should be analyzed through this gateway
- the engine instances of those motors
- which alarms you want to receive on your dashboard

This is possible through the “Link Up Configurator” smartphone App, which can be downloaded free of charge from the stores of both Android and iOS devices.

A simple and detailed explanation of the configuration process is also available as in-app instructions.

Thanks to the passive embedded NFC receiver, the Link Up gateway can be configured, as described below, without the need of power supply.



**LINK UP
CONFIGURATOR**



Link Up Configurator App is available for both iOS and Android devices

GATEWAY CONFIGURATION



1. Launch the “Link Up Configurator” App and read the actual configuration of the Link Up device by “tapping” the smartphone onto the Link Up wireless area (indicated by the red arrow).

NOTE: The antenna position on the smartphone depends on the model. Please refer to the smartphone manufacturer manual.

CONFIGURATION

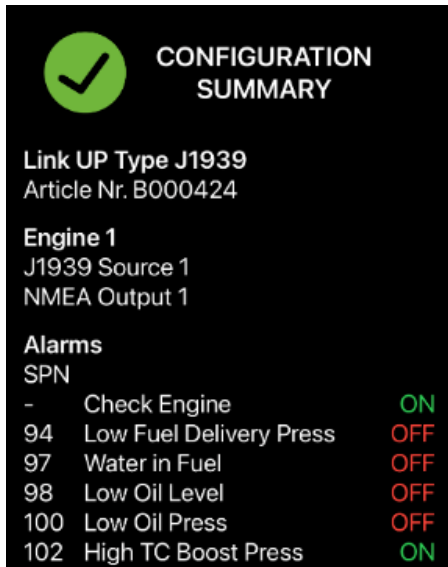

CONFIGURATION SUMMARY

Link UP Type J1939
Article Nr. B000424

Engine 1
J1939 Source 1
NMEA Output 1

Alarms
SPN

-	Check Engine	ON
94	Low Fuel Delivery Press	OFF
97	Water in Fuel	OFF
98	Low Oil Level	OFF
100	Low Oil Press	OFF
102	High TC Boost Press	ON

2. After the readout, the App will show the “Configuration Summary”, which displays all the current settings of the device.

To modify the configuration, press the “Change Configuration” button.

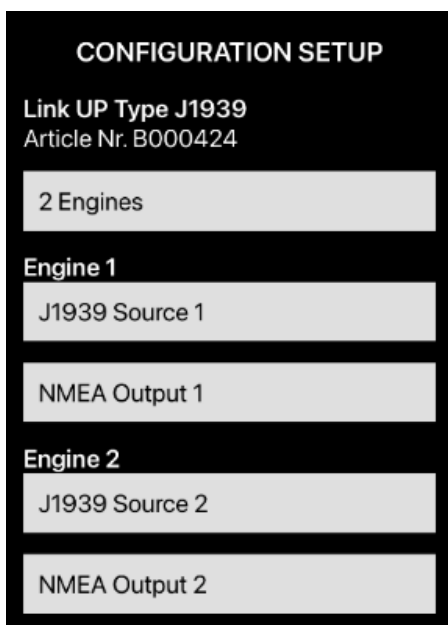

CONFIGURATION SETUP

Link UP Type J1939
Article Nr. B000424

2 Engines

Engine 1

J1939 Source 1

NMEA Output 1

Engine 2

J1939 Source 2

NMEA Output 2

3. Select whether you’ve got one or two engines on your vessel.

Then choose for each engine its source number that is used in the J1939 system as well as the instance which should be used in the NMEA 2000 network.

CONFIGURATION

Alarms		
SPN		
-	Check Engine	<input checked="" type="checkbox"/>
94	Low Fuel Delivery Press	<input type="checkbox"/>
97	Water in Fuel	<input checked="" type="checkbox"/>
98	Low Oil Level	<input checked="" type="checkbox"/>
100	Low Oil Press	<input type="checkbox"/>
102	High TC Boost Press	<input type="checkbox"/>
106	High Air Inlet Press	<input checked="" type="checkbox"/>
110	High Coolant Temp	<input checked="" type="checkbox"/>
111	Low Coolant Level	<input type="checkbox"/>
124	Low Transm. Oil Level	<input type="checkbox"/>
127	Low Transm. Oil Press	<input checked="" type="checkbox"/>

4. After that, you can choose, which alarms you want to show up on your dashboard.

Once the settings are completed, press the "Write Configuration" button to prepare the download.

See the "Supported Alarms" section of this manual for the complete list of supported alarms.



5. To download the configuration, simply "tap" the smartphone again onto the Link Up wireless area, as described on step 1.

The configuration is instantaneously transferred to the device, and the new "Configuration Summary" is displayed.

SUPPORTED DATA

The Link Up J1939 is able to translate the following information:

CAN J1939			NMEA 2000	
Data	PGN	SPN	Data	PGN
Engine Speed	EEC1	190	Engine Speed	127488
Engine Hours	HOURS	247	Total Engine Hours	127489
Engine Load	EEC2	92	Engine Percent Load	127489
Engine Oil Temp	ET1	175	Engine Oil Temp	127489
Engine Oil Press	EFL	100	Engine Oil Temp	127489
Coolant Temp	ET1	110	Engine Temp	127489
Coolant Press	EFL	109	Engine Coolant Pressure	127489
Boost Press	IC1	102	Engine Boost Pressure	127488
Trans Oil Press	TRF1	127	Transmission Oil Pressure	127493
Trans Oil Temp	TRF1	177	Transmission Oil Temperature	127493
Exhaust Temp	IC1	173	Exhaust Gas Temperature	130316
Fuel Level	DD	96	Fluid Level (Fuel)	127505
Fuel Press	EFL/P1	94	Fuel Pressure	130314
			Fuel Pressure	127489
Fuel Rate	LFE	183	Fuel Rate	127489
Inst Fuel Economy	65266	184	Instant Fuel Economy	127497
Alternator Current	65271	115	Battery Current	127508
Alternator Potential	65271	167	Alternator Potential	127489
Battery Potential	65271	168	Battery Voltage	127508
Transmission Gear	61445	523	Gear Position	127493
Percent Torque	61444	513	Percent Engine Torque	127489

SUPPORTED ALARMS

Alarm	SPN
Check Engine	-
Low Fuel Delivery Pressure	94
Water in Fuel	97
Low Oil Level	98
Low Oil Pressure	100
High Tc Boost Pressure	102
High Air Inlet Pressure	106
High Coolant Temperature	110
Low Coolant Level	111
Low Transmission Oil Level	124
Low Transmission Oil Pressure	127
Low Electrical Potential	168
High Exhaust Gas Temperature	173
High Oil Temperature	175
High Transmission Oil Temperature	177
Engine Overspeed	190

LED NOTIFICATION

LED behavior	Description
OFF	Device not powered.
ON	Device configured and in operation.
Slow blink (1Hz)	Device in operation with invalid or empty configuration (factory settings). Waiting for configuration by the user. NMEA 2000® messages are NOT transmitted.
Fast blink (2Hz)	Link Up doesn't receive valid data over the J1939 CAN bus NMEA 2000® messages are being set as "invalid".
Very fast blink (10Hz)	Device reconfiguration in progress after wireless download.

TECHNICAL DATA

LINK UP DATASHEET

Operating voltage	6 - 16.5 V
Nominal voltage	12 V (from NMEA 2000® network)
Power consumption	≤100 mA
NMEA 2000® LEN	2
Operating temperature	-30°C to 80°C
Sensor cable length	25 cm
NMEA 2000® cable length	25 cm
CAN J1939-Network plug	Deutsch DT04-6P (Male)
Counterpart for CAN J1939-Network plug	Deutsch DT06-6S (Female)
NMEA 2000® plug	DeviceNet Micro-C M12 5 pins - Male
Protection class	IP X7 according to IEC60529 (when connected)
Flammability	UL94-HB
Compliance	CE, Reach, RoHS

DIMENSIONS

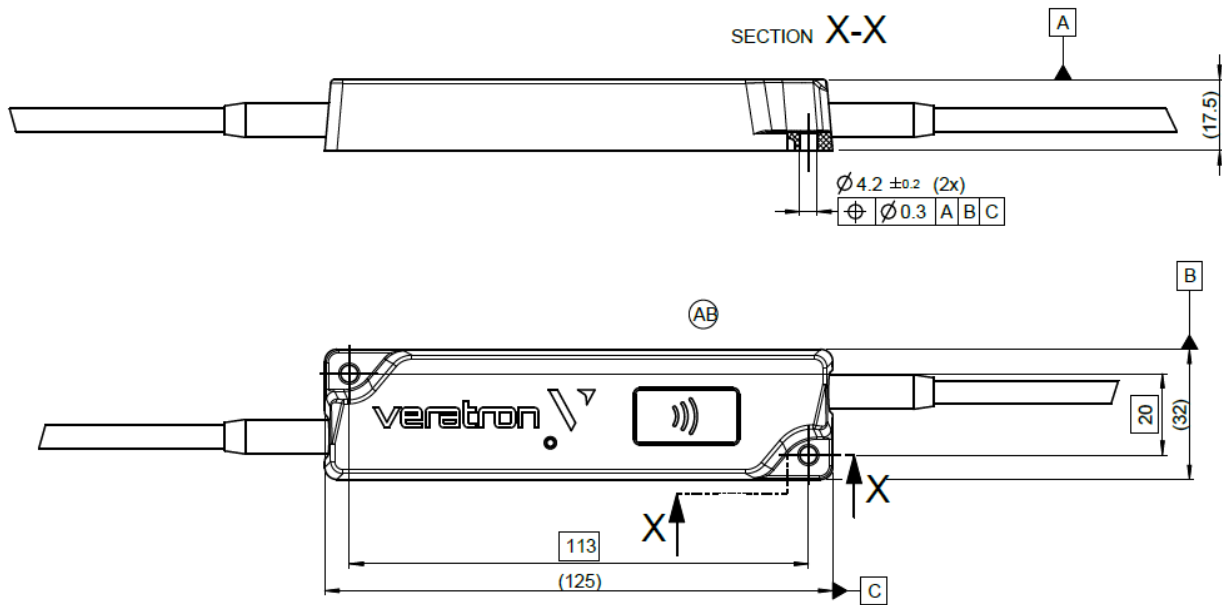

PINOUT

Pin No.	Description
1	Shield
2	NET-S (V+)
3	NET-C (V-)
4	NET-H (CAN H)
5	NET-L (CAN L)

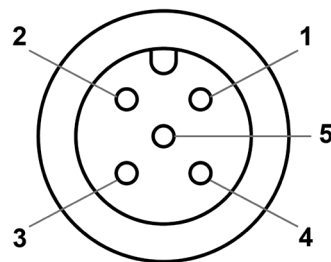

Micro-C M12 5 poles plug
Male, product side view

TECHNICAL DATA

Pin No.	Wire color	Description
1	Blue	CAN Lo
2	-	N.C.
3	White	CAN Hi
4	Black	GND
5	-	N.C.
6	Red	KL. 15 - Power (12V)

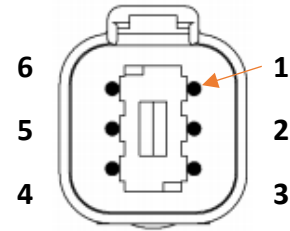

Deutsch DT04-6P plug, front view



veratron AG
Industriestrasse 18
9464 Rüthi, Switzerland

T +41 71 7679 111
info@veratron.com
veratron.com

Any distribution, translation or reproduction, partial or total, of the document is strictly prohibited unless with prior authorization in writing from veratron AG, except for the following actions:

- Printing the document in its original format, totally or partially.
- Copying contents without any modifications and stating veratron AG as copyright owner.

Veratron AG reserves the right to make modifications or improvements to the relative documentation without notice.

Requests for authorization, additional copies of this manual or technical information on the latter, must be addressed to veratron AG.