



VEXILAR FL/FLX SERIES OWNERS MANUAL

FL-8®SE | FLX-12 | FL-18 | FLX-20 | FLX-28 | FLX-30BB

Contents

Vexilar History	2	Open Water Options	19	Flasher Accessories	70
How Sonar Works	3	Features & Specifications	20	Transducers Options	72
Basic Concepts of Vexilar Use	4	FL-8®SE Operation	22	Transducer Switches and Extensions	73
The Vexilar Display	5	FLX-12 Operation	24	Storage & Prevention Tips	74
Interference Rejection Explained	6	FL-18 Operation	26	General Trouble Shooting	74
Vexilar Ice Fishing	7	FLX-20 Operation	30	Electrical Interference	75
Seeing Your Lure	8	FLX-28 Operation	36	Vexilar Support	76
The Ice-Ducer	9	FLX-30BB Operation	44	Two-Year Extended Limited Warranty	78
About Transducers	10	FLX-30BB Display Messages	49	Extended Limited Warranty	79
Dead Zone	11	FLX-28 and FLX-30BB Color Palettes	56	Warranty Information	80
Boat Use	12	The Genz Pack System Case	58		
Fishing Vegetation	13	The Pro Pack II Case	60		
Boat Installation	14	The Ultra Pack Case	62		
Power Connection	14	SLA Battery Charging	64		
Transducer Installation	15	Vexilar Lithium Charging	66		
Transom Transducer Mounting	16	Battery Warranties	68		
In-Hull Transducer Mounting	17	Vexilar Lithium Warranty	68		
Electric Trolling Motor Mounting	18	DD-100 Digital Depth Indicator	69		

MNL017U RV2020

VEXILAR HISTORY

Pioneers in Marine Electronics

Established in 1960, Vexilar, Inc. has been a leading innovator of marine electronics in the sport fishing industry for over 60 years.

Some of our innovations include the first:

- Straight-line paper graph for sportfishing (model 155)
- CRT (television) display (model 660)
- Color display (model DE-12)
- Fish alarm (model 120-SOS)
- Liquid Crystal Display (LCD) (model 480)
- Self-leveling ice fishing transducer design (Ice-Ducer)
- The first split-screen zoom flasher (model FL-18)
- Shoot-through-aluminum transducer design (AlumaDucer)
- 10' Range Flasher (FL-22HD)
- Transducer with three cone angles in one housing.
- WiFi sonar driven by mobile app (SonarPhone)
- Aftermarket Digital Depth Display for FL flashers (DD-100)
- Flasher to use Brushless Data transfer tech (FLX-28)
- Broad Band flasher sonar (FLX-30BB)

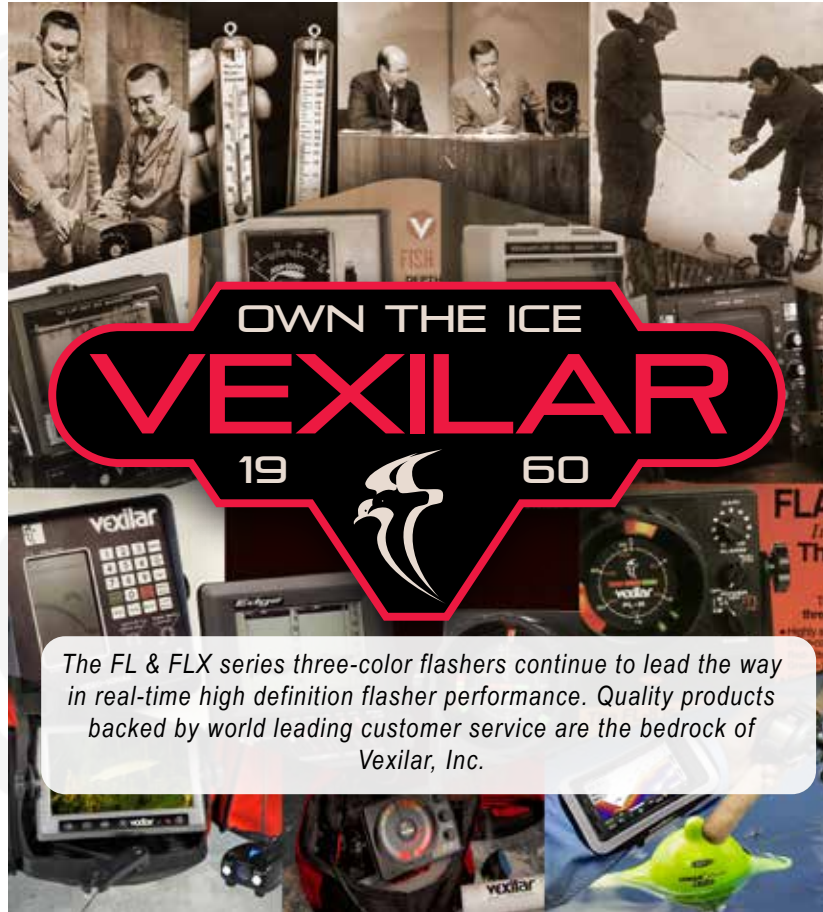

The FL & FLX series three-color flashers continue to lead the way in real-time high definition flasher performance. Quality products backed by world leading customer service are the bedrock of Vexilar, Inc.

How Sonar Works

SONAR stands for SOund NAVigation and Ranging. Sound travels through fresh water at a speed of approximately 4920 feet per second. A sonar device (depth finder/fish finder) measures the amount of time a burst of energy takes to travel to the bottom and return to the transducer. This time variation is then displayed on the readout of your sonar. When the depth gets deeper, the time of travel for the sound increases. The burst of energy, known as the transmit pulse, is generated by the sonar's transmit circuitry. This burst is delivered to the water via the transducer. The return signal, known as the echo, is received by the receiver circuit, also via the transducer. A central processing unit makes the calculations to determine the depth and signal strength of the bottom and other targets.

The sonar signal sent from the transducer will reflect, or bounce off of any object that has a different density than water. This makes it possible to detect not only the lake bottom, but also vegetation and fish.

How Flashers Work

The sonar portion of a flasher works in the same manner as any other graph or LCD sonar device. The difference is in how the return signal is displayed. Instead of adding the data to a progressive representation of the bottom to construct a history, the data on the flasher display always represents the current point in time, also known as "real time". The display consists of a wheel with indicator lights mounted in one location. The wheel is spun at high speed and the lights turn on and off rapidly to show the sonar readings.

The Vexilar Advantage

Vexilar's sonar design offers an optimal balance between the power of the transmitted pulse and the sensitivity of the receiver circuit. Excessive power has been shown to cause premature transducer failure, distortion of the sonar signal, and possibly spook fish from the audible noise they hear. Vexilar provides a balanced performance level for a wide range of fishing scenarios.



Flasher Wheel Stationary

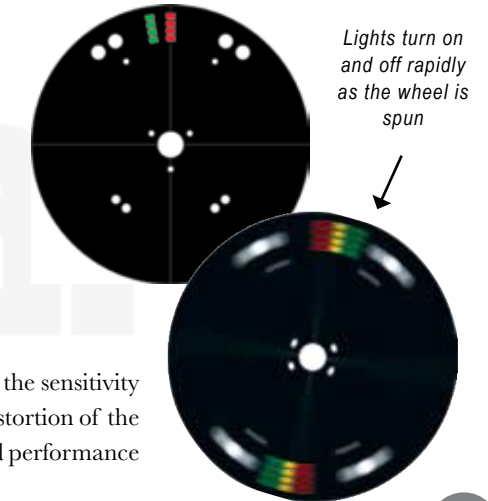

Flasher Wheel Spinning

BASIC CONCEPTS OF VEXILAR USE

Vexilar FL/FLX series color flashers are great tools for open water and ice fishing. Once you learn to understand the basic concepts and meaning of the color display, you can apply this knowledge to greatly increase your fishing success. All the FL/FLX Series flashers can be used for:

- Determining the current depth at any boat speed.
- Locating fish-holding underwater structure.
- Determining the bottom hardness and transition lines.
- Penetrating thick vegetation to see what's below.
- Finding fish and the bait they feed on.
- Watching your bait and the fish around it.

Range Control

Depth Range determines the maximum depth of water in which the flasher can see the bottom. For example, the shallowest range available on the FL-18 is 0 to 20 feet. This means that if the water depth is between zero and 20 feet, the bottom will be displayed on the screen. If the water depth gets deeper than 20 feet, you will need to select a deeper depth range in order to see the bottom. It is usually best to select the shallowest depth range possible to see the bottom. This allows the water column below to be represented by the greatest amount of display screen area. This offers the highest resolution, makes things bigger and easier to see.

Gain Control

Gain controls the amount of amplification applied to the return sonar signal. Think of gain as your volume control. You turn up the gain to see more of what's below. You turn down the gain to see less of what you don't want to see. The goal is to find a gain level that shows you as much real information as possible, without displaying stray signals of clutter and interference. Keep the gain setting as low as possible for best overall performance.

Gain can act as a variable cone angle. As you increase the gain level, you can see things further away from the transducer. This can be helpful in uncluttered conditions. If you don't see anything on the screen (other than bottom), turn up the gain temporarily and see if anything shows up. If it does, it could be a fish some distance away from your transducer. Unfortunately, this won't work in cluttered water, such as weedy conditions, because the objects in the center of the cone will get amplified and overlap anything on the outside, making these objects impossible to distinguish. This is the hallmark of the Pro-View transducer.

Interference Rejection

This feature rejects sonar interference generated by other nearby depth sounders. Interference Rejection, or IR, comes on automatically when you turn the flasher on, and you can further adjust it if needed. See page 6 for details.

THE VEXILAR DISPLAY

Each FL series flasher display consists of multiple colors (marks) which appear at various positions on the screen. Understanding what the colors mean, and the position and size of the colored marks, is the key to being able to interpret the information correctly.

RED = Strong Strength Signals. Strong signals are generally produced by significant underwater objects, such as the bottom, heavy vegetation, and large fish. However, smaller objects, such as bait fish, can display as red if the object is directly under the transducer.

ORANGE = Medium Strength Signals. Medium signals are produced by smaller objects and softer bottom types. Also, medium strength signals can be produced by larger objects in the immediate area around, but not directly under, the transducer.

GREEN = Weak Strength Signals. Weak signals are produced by small objects, such as light vegetation, bait fish, and even air bubbles or aquatic micro marine life. Larger objects off to the sides of the transducer can also be displayed as green.

FLX-28 and FLX-30BB models have additional color options. See page 56 for more information.

Understanding the Display Marks

This is the basics of what you will see on the display.

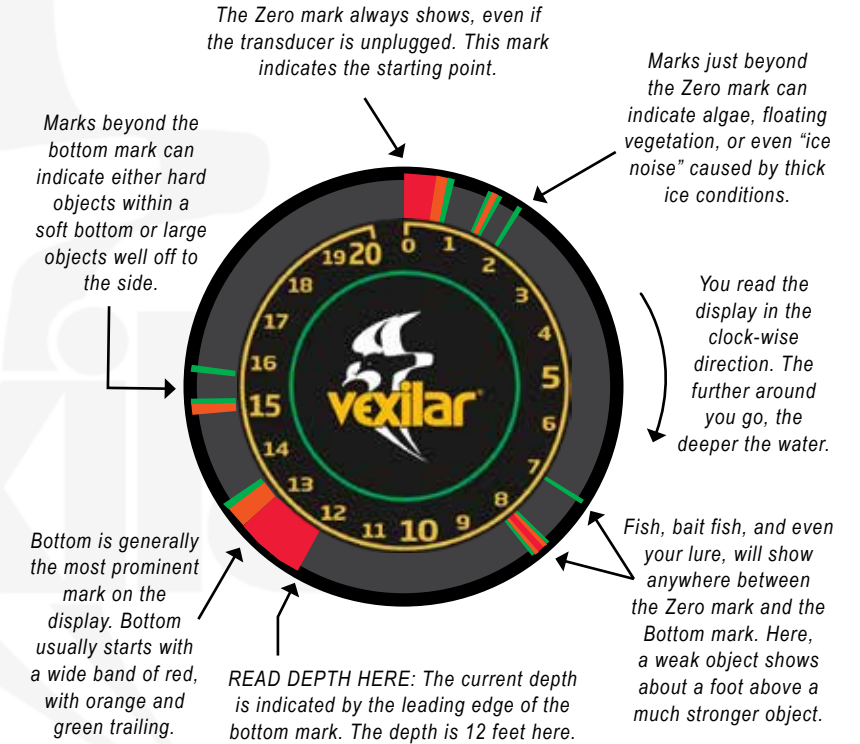

INTERFERENCE REJECTION EXPLAINED

The purpose of interference rejection is to reduce cross-talk interference from other nearby depth sounders. This can be very helpful if you have another sounder mounted on your boat running at the same frequency as your flasher. It is also helpful when other anglers are running sounders operating at the same frequency as your flasher nearby.

Cross-talk interference occurs when the signals sent from one depth sounder are received by another. If the two sounder's frequencies are the same, each unit is unable to differentiate between its own signals and others. What you see as interference is actually the reading of the other sounder displayed on your screen. The signals can circle around the display or remain stable. Beware of the stationary interference signals. They can lead you to believe the depth is different than it is or that there's a fish hanging below you which really isn't there.

Usually, when you see interference on one sounder, the other sounder will show it too. Therefore, when you use your Interference Rejection to reduce or eliminate the interference on your display, the other sounder will see a similar reduction. This means you can use your Vexilar flasher next to another sounder which does not have the I.R. feature and both sounders can run more clearly.

If two Vexilar units are operating together, you will get the best results by leaving the IR setting at one level on one unit, while adjusting out the interference displayed on both units using the second unit's IR feature.

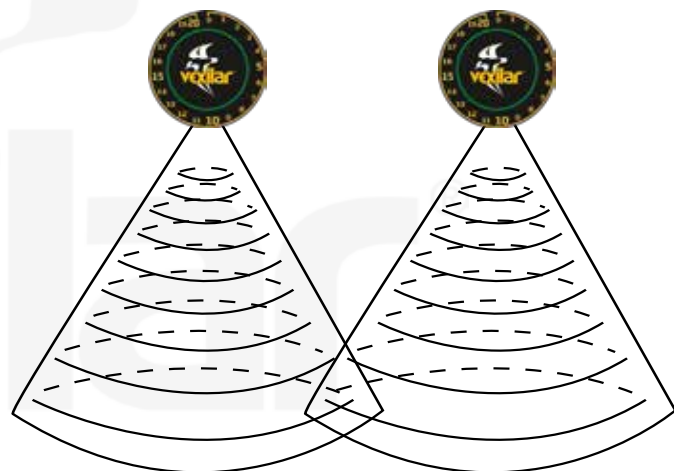

Interference occurs when the cone angles of two different sounders operating at the same frequency intersect. It can also occur if the sonar signal from one sounder bounces off an underwater object and is received by another sounder.

VEXILAR ICE FISHING

The Vexilar FL & FLX series color flashers offer distinct advantages over LCD depth sounders for the sport of ice fishing. This unique style of fishing offers a stable platform to fish from. Because everything is so stable, the only movements below are that of fish.

Additionally, the conditions allow you to drop your bait directly down into the center of the transducer's cone of sound. This allows you to be able to see your bait and the fish on the display at the same time. You can tease the fish and see his reaction in real time.

With practice, you will soon be able to judge for yourself both fish species as well as the mood of the fish, and whether your lure presentation is working or not.

Please Use Caution

Before venturing onto the ice to go fishing, be sure you know if the conditions are safe. Check with the local bait shops AND cautiously check the ice thickness yourself. You should have at least 6" of clear ice to safely support yourself and your ice fishing equipment.

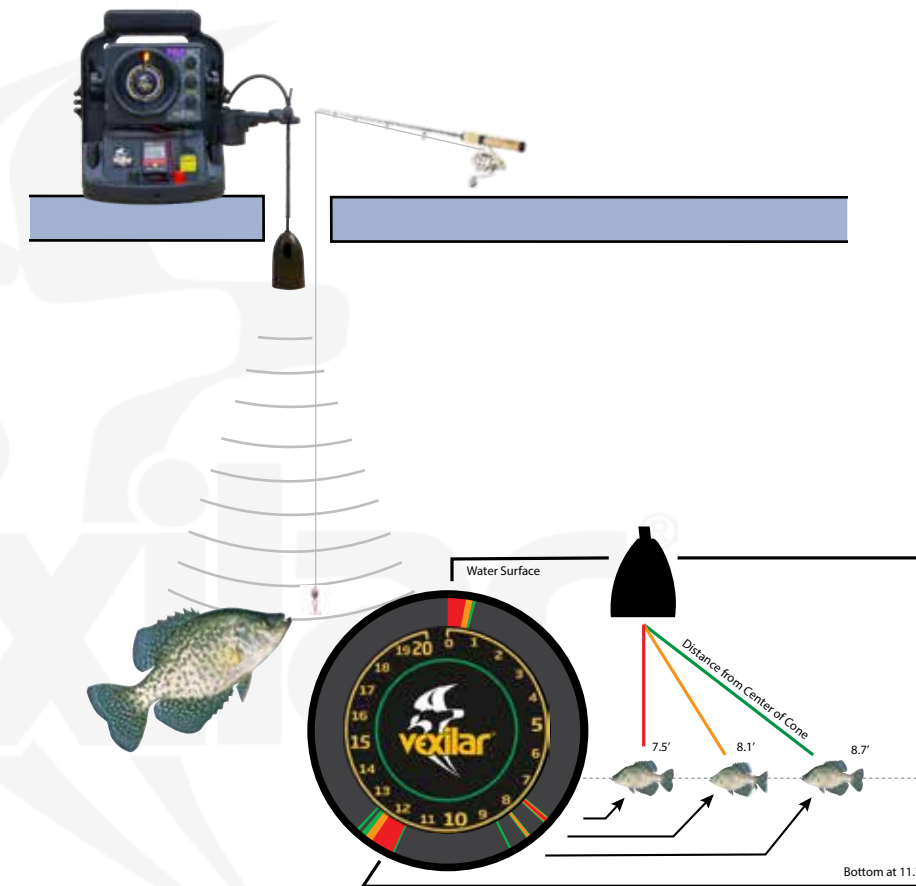

SEEING YOUR LURE

The key to ice fishing success when using a Vexilar ice fishing system is the ability to see your fishing lure and its relationship to the bottom, structure, and fish. Ice fishing with a Vexilar allows you to present your lure to the fish. You see the fish on the display and you raise your lure so it is right above the fish on the display. If the fish is hungry, it will bite. If not, it will react in some way to your presentation, such as with disinterest or fear. You can see this reaction on the flasher display and adjust your tactics accordingly.

Setting the gain level correctly is important to be able to understand what's going on below you. Use the lure's appearance as your reference for adjusting the Gain Control. Set it so your lure appears as a green signal. Because the fish are much larger than your bait, they will appear as stronger signals. Be prepared to readjust the Gain Control up and down often, as small position changes and the condition of any bait attached will effect the strength of your lure's signal.

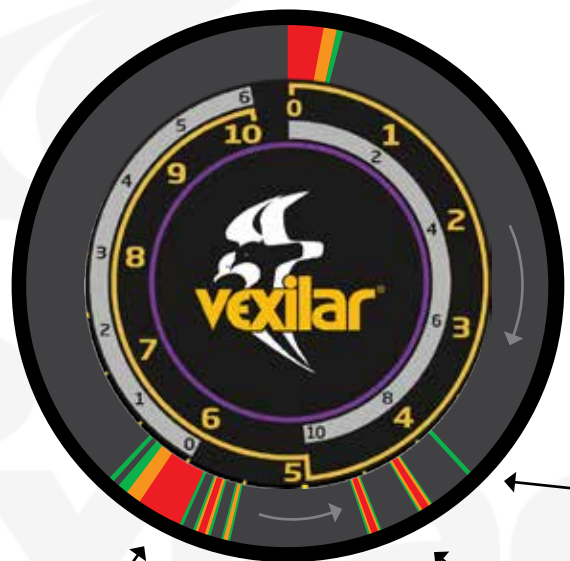

Typical Ice Fishing View

This illustrates a typical panfish fishing view. As you lower your lure, you see it going down on the display while the curious fish rise to see what it is. When the two signal lines meet, it is time to be ready for a strike.

Lure

With the Gain Control set properly, your lure will appear as a weak signal. You want it to appear small next to the fish, which are much larger.

Bottom

Several fish are holding near the bottom. The thin green line right on the bottom may be a fish just up off the bottom, as the others are, but some distance to the side.

Fish

A pair of fish are rising to your lure as it is being dropped down. This is a good sign, as competition can make fish more aggressive.

THE ICE-DUCER

Vexilar ice fishing systems include a special type of transducer patented in 1997 called the Ice-Ducer®. This transducer style is designed specifically for the ice fishing application. The Ice-Ducer® works off the “plumb-bob” theory. When suspended by the cable, the transducer cone is perfectly aligned to point straight down.

Stopper - The stopper sets the depth of the transducer. It's adjustable so you can set the depth according to your preference or conditions. Generally, you want to set it so the bottom of the transducer is even with the bottom of the ice.

Float - The float suspends the transducer in the ice hole. You can also use the eye-bolt included with the Vexilar ice fishing systems to suspend the transducer. This can often be the best choice for early ice conditions.

Cable - Ice-Ducer® cable is specifically designed to stay flexible in cold temperatures. This flexible cable will be more prone to be cut by your line or damaged if not stored correctly. It's a key part of the Ice-Ducer® system.

Transducer - The transducer is designed to allow a perfectly downward alignment while suspended and be able to endure the severe conditions encountered in the ice fishing environment. Different cone angles are available to match your fishing needs; 9° Pro-View, 12°, 19° and Broad Band (FLX-30 Only). Transducer sizes will vary. See page 72 for more information.

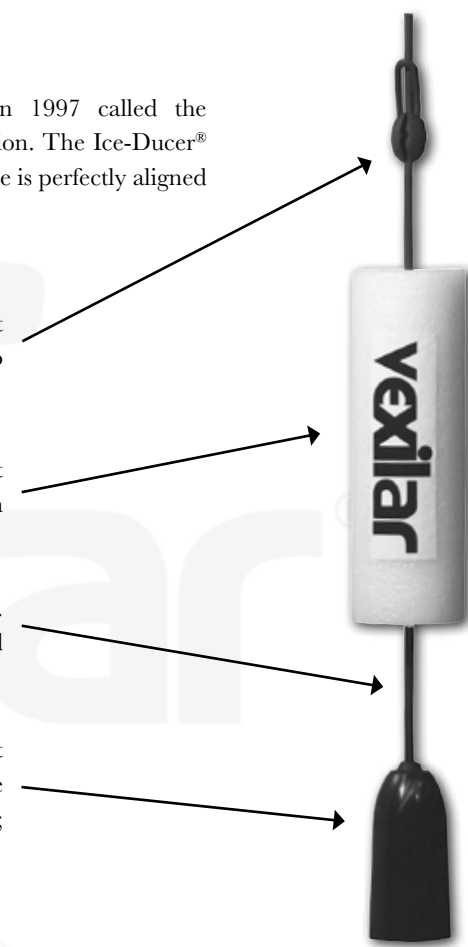

ABOUT TRANSDUCERS

Cone of Sound

The cone of sound is the area the sound waves cover as they are emitted from the transducer. Generally, this area is thought of as three-dimensional cone, such as an upside-down ice cream cone. In actuality, the cone of sound is not so precisely defined. It is an irregular shape with edges that taper rather than end abruptly. Additionally, the cone of sound will vary slightly from transducer to transducer.

Most objects are visible inside the theoretical cone, but you can also see objects outside the theoretical angle yet within the side and main lobes. These objects must be large enough to sufficiently reflect the sonar signal. Some of these objects can be things like the face of a sharp dropping bottom, a large rock, or even a good size fish or tight group of smaller fish.

The FLX-30 uses a special broad band transducer that offers a wide spectrum of cone angles that vary with each frequency. The multi-frequency system has different characteristics than the single-frequency transducer described here. Broad Band transducers do not have side lobes.

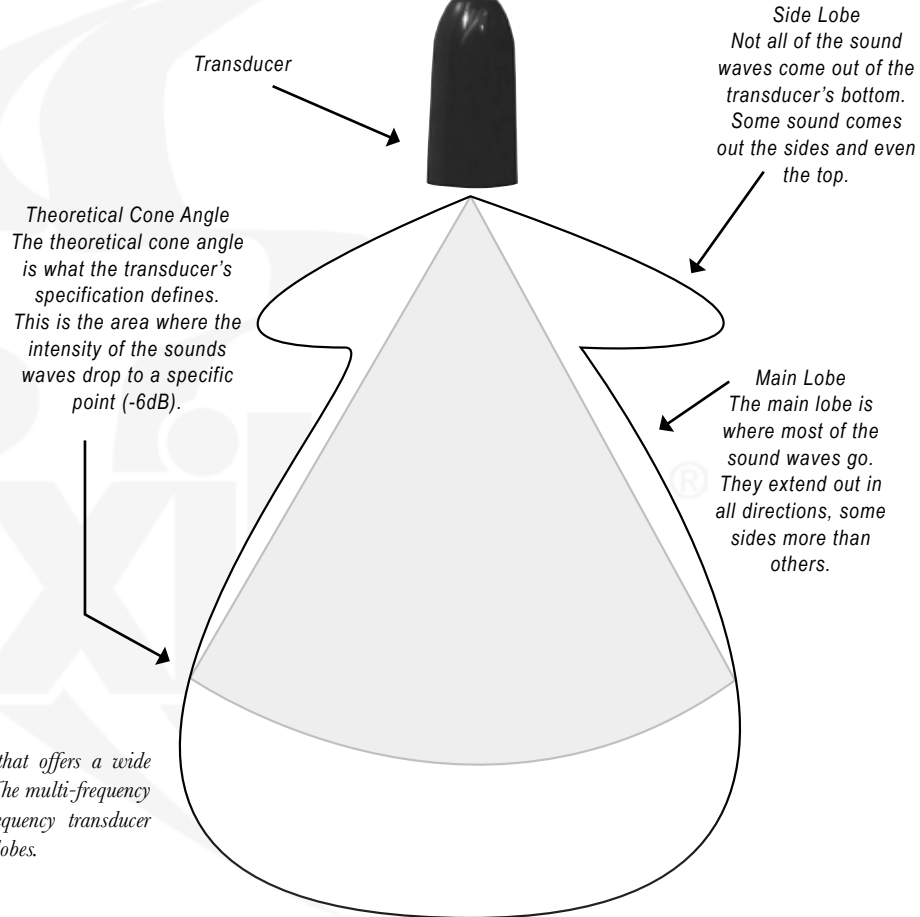

DEAD ZONE

Beam angle has a large effect on the performance of your flasher. There is more to it than simply area of coverage. The correct beam angle to use depends entirely on your application. If you are fishing for suspended fish then you would be pleased with the performance of the 19° cone. However, if you were going after fish that are holding right on the bottom along a steep drop-off, you would have better results with the 9°. This is because of something called dead zone. Dead zone is an area within the transducer's cone of sound that is blind to you. The wider the beam angle the greater the possible dead zone. The sonar will mark bottom as the nearest distance it sees. If you are fishing over a slope, it may see the high side of the slope, at the edge of the cone, and mark that as bottom. The fish that are holding on the bottom on the low side of the slope will be invisible to you because they are actually within the bottom signal on your depth finder. A narrower beam angle will reduce this effect.

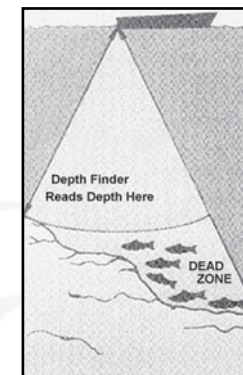

		Cone angle vs Diameter of Coverage				
Depth	8°	9°	12°	19°	20°	
10'	1.4'	1.6'	2.2'	3.4'	3.5	
20'	2.8'	3.2'	4.3'	6.7'	6.9	
30'	4.2'	4.7'	6.3'	10.0'	10.6	
40'	5.6'	6.3'	8.4'	13.4'	14.1	
50'	7'	7.9'	10.6'	16.7'	17.6	
60'	8.4'	9.4'	12.6'	20.8'	21.2	
70'	9.4'	11.0'	14.7'	23.4'	24.7	
80'	11.2'	12.6'	16.8'	26.8'	28.2	
90'	12.6'	14.2'	20.0'	30.1'	31.7	
100'	14'	15.7'	21.0'	33.5'	35.3	
120'	16.8'	18.9'	25.2'	40.2'	42.3	
150'	21'	23.6'	31.5	50.2'	52.9	

Output Power

Your depth finder puts out a constant amount of power, or sound energy. It does not matter where you have the gain level set. Gain simply controls how much you amplify the signal that is returned from below. Therefore, a narrow beam transducer will appear to be much more powerful than a wide beam transducer. This is because you are putting that same amount of power into a smaller area. This can be an advantage if you are fishing in deep water or a detriment if you are fishing in shallow water. A narrow beam transducer can be overpowering in shallow water. The use of the LP (Low Power) Mode on your flasher, or the optional S-Cable (page 70), will solve this problem.

Remember to NOT use LP Mode or the S-Cable in depths beyond 20 feet. You will find that you need to turn your Gain Control up much higher than normal. This will give a noisy display and make interference from other units much more likely.

BOAT USE

Navigation

The Vexilar flashers are great tools for navigation while boating. The instantaneous readings offer the ability to identify depth changes quickly. Here are some tips to help you navigate safely.

CAUTION:

- Be sure you know which range you have selected. If you think you have the flasher set to a deeper range than what it actually is, you may run aground unexpectedly.
- Be aware that although the depth displayed may be deep enough to navigate in presently, shallow water may be dead ahead. Allow yourself plenty of time to slow down if shallow water is encountered.
- If no bottom is displayed, assume the depth is dangerously shallow. It may be deeper than the selected range, but never assume so.
- Use common sense. Do not trust the flasher as the ultimate source of information. Use good judgment as well.

Bottom Content

The Vexilar flashers are also great tools for determining bottom content changes. The colors allow you to easily see when the bottom changes from one type to another.

Hard or Soft Bottom

- Hard bottoms will generally appear as a narrow band with color content of mostly red and orange.
- Soft bottoms will appear as a wide band with more orange and green than red.



Hard Bottom



Soft Bottom

FISHING VEGETATION

The Vexilar flashers are exceptional when it comes to reading inside vegetation. With proper transducer choice, the colors will allow you to differentiate vegetation from the bottom. Experience will even allow you to identify fish inside heavy vegetation.

Tips for Reading in Vegetation

- Narrow transducer cone angles will perform better than wide cone angles.
- Keep the gain setting very low. Too much gain will make readings difficult.
- Move a boat slowly so you can identify openings that may hold fish.

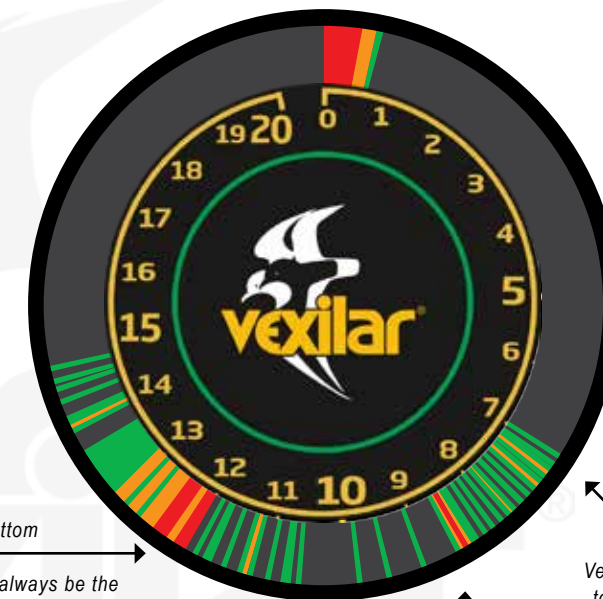

Bottom
Bottom will always be the largest group of red and orange signals.

Orange within the green generally indicates thicker sections of the vegetation. Although it warrants watching, as it could also indicate a fish on the outer edge of your cone.

Possible Fish

Although this red target could indicate a clump of vegetation, it could also indicate a fish just under the canopy

Vegetation has grown up to this point. In deeper water (beyond several feet) this is known as the canopy. It's where the tops of the vegetation spread out

BOAT INSTALLATION

Mounting the Flasher Unit

Take a few minutes to plan your installation. The unit should be mounted in a location where it will be readily visible yet out of the way of traffic. The mounting surface should be fairly flat. Be sure to allow clearance for the cables at the rear of the unit while it tilts and swivels. The unit is weather-proof, not waterproof, so try not to mount it in a location where it will be exposed to the extreme forces of wave impact during severe conditions.

To Install the Flasher Unit

1. Obtain four appropriate fasteners for your mounting location.
2. Remove the flasher unit from the gimbal bracket by removing the two gimbal knobs on each side of the unit.
3. Position the bracket in your intended mounting location.
4. Mark the four holes and drill each using the appropriate drill size.
5. Attach the gimbal bracket using your four fasteners. Tighten securely.
6. Replace the flasher unit into the gimbal bracket and tighten the gimbal knobs.

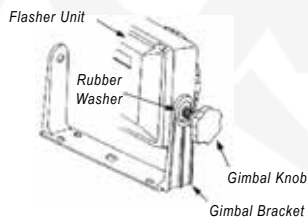

Power Connection

Your flasher unit requires a 12 volt power source to operate. A connection can be made directly to a battery or a connection can be tapped into a boat's electrical system.

- If possible, power your flasher using the main starting battery, not a battery that powers an electric trolling motor.
- When routing the cable, be sure to stay away from, or provide cable protection around, areas with sharp metal edges.
- If the supplied power cord is too short, extend it using 18 gauge wire.
- **IMPORTANT:** Be sure to have circuit protection, such as a 1 amp fuse or circuit breaker, placed in the positive line near the power source to protect the wiring.

To connect the flasher to power:

1. Be sure the power cord is not connected to the flasher.
2. Route the power cable from the flasher location to the power source.
3. Connect the white or red wire to the positive power source terminal and the black wire to the negative terminal.
4. Connect the power plug to the flasher's power jack.

TRANSDUCER INSTALLATION

Types and Mounting Methods

There are several different transducer types used for the various mounting options available to you. Choose the style which best meets the needs for your mounting application.

Transducer Types

- **High-Speed Transom:** This style is designed to be mounted externally on the transom of your boat. It has a special wedged shape to allow clear water flow when running at high boat speed.
- **Puck Style:** Puck transducers are meant for attachment to an electric trolling motor. They have a special curved shape and attachment slots just for this purpose. Pucks are also commonly used for in-hull mounting within fiberglass boats.



High-Speed Transom



Puck Style

Mounting Methods

- **Transom Mounted:** the method by which the transducer is mounted externally on the back of the boat. The transducer is attached at the bottom of the transom with a small portion of it extending below the hull line. (see page 17)
- **In-Hull Mounting:** the method by which the transducer is glued to the inside of the hull of the boat. The sonar signal shoots through the hull and into the water. (see page 15)
- **Trolling Motor Mounting:** the method by which the transducer is attached to the lower unit of the electric trolling motor. (see page 18)
- **Portable Mounting:** the solution when easy transducer removal from the boat is desired. Generally, a suction cup bracket is used to attach either a high-speed or puck style transducer to the rear of the boat. (see page 19)

NOTE: If you find that you have purchased the wrong transducer for your intended mounting application, you can exchange it with Vexilar. You will only need to pay the retail cost difference, plus shipping, of the transducer style needed. Transducers must be in new condition. Please call for more information; 952-884-5291

TRANSOM TRANSDUCER MOUNTING

Before you begin the process of installing the transducer, check your hull to find a spot where you'll get a smooth water flow along the bottom of the boat. You want to avoid ribs, rivets, and gouges or scratches in the hull. To get a true vertical depth reading, the transducer should be mounted parallel to the water line. However, a 10° tilt to either side is acceptable. If the hull is reasonably flat with a dead rise of 10° or less, mount the transducer along the hull bottom. If dead rise is greater than 10°, mount the transducer with level alignment.

To Install the High-Speed Transducer

1. Assemble the stainless steel brackets to the transducer using the hardware furnished. Do not tighten until final adjustments are made.
2. Place assembly on transom at selected location with the front of the transducer extending 1/2" to 5/8" below the bottom of the boat and with the front part against the transom. The least amount that the transducer extends below the bottom is desired. If too low, spray and turbulence will occur resulting in lost bottom readings.
3. With transducer in place, mark the four slot locations of the mounting brackets. Drill in center of slot outline using a 9/64" (3.5 mm) drill.
4. Fasten the transducer to the transom using the #10 x 3/4" screws, nuts and washer plates.
 5. Before final tightening of the 4 screws holding the brackets to the transducer, tip the rear edge down approximately 1/8" as shown.
 6. Tighten all screws.

CAUTION: Do not use any thread locking compound on the screws. Most products such as Loctite® contain chemicals that attack and weaken plastics.

IMPORTANT: There should be no gap between the brackets and the transducer. A wide space between these parts will cause stress on the transducer mounting ears and result in breakage with time.

When running the cable to the sounder, avoid other wiring on the boat, particularly ignition and alternator cables. They can be a source of noise on the sounder display.

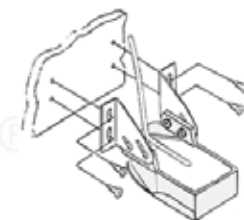
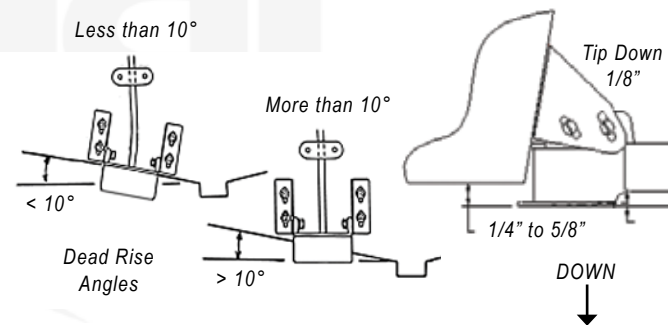

IN-HULL TRANSDUCER MOUNTING

Surface preparation and location are the keys to having a good sonar transducer installation that will last for years, so please take a few extra minutes to test the location and prepare the surface area. Also, the hull temperature should be at least 60° F while performing the installation. Select an area in your boat. Ideally, for high speed operation, you will need to place the transducer near the center of the transom area of the boat, which is often near the drain plug. You must attach the transducer to a solid hull area; this means you cannot have double hull aluminum or a foam layer in the fiberglass between the transducer and the water.

To Install the In-Hull Transducer

1. Prepare the surface area. It is critical you find a smooth, flat spot to place your transducer. Small ridges, bumps or even paint under the transducer will affect the quality of the sonar signal. Your surface preparation kit comes with a Scotch-Bright® pad to smooth any rough areas down to the base material for a secure installation. Use the pad to rough-up the face of your transducer a little too. This will also aid in the long-term quality of your installation.
2. Clean the area. Use the supplied cleaning patch of Isopropyl Alcohol to remove dust and dirt from the target mounting area. Be sure to also wipe clean the face of your transducer. Let dry for a few minutes.
3. Position the transducer. Place the transducer exactly where you want to install it. Apply the four supplied positioning pads around the transducer. The positioning pads are needed to prevent your transducer from drifting off the target area while the A.C.E. adhesive sets up.
4. Mix and apply the epoxy. Follow the mixing directions on the packet of A.C.E. Adhesive and apply the entire packet contents directly to the face of the transducer.
5. Install the transducer. Place the transducer into position. Press firmly and twist slightly back-and-forth to work-out any air bubbles that might have been trapped in the epoxy.
6. Installation complete. Allow the A.C.E. to dry.

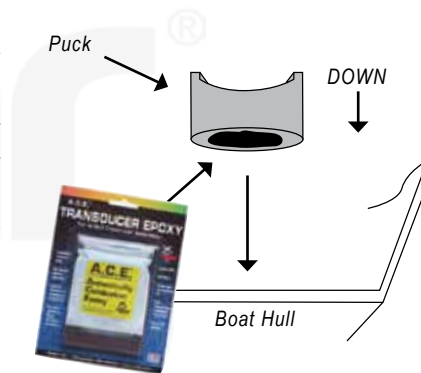

ELECTRIC TROLLING MOTOR MOUNTING

There are two main styles of trolling motors: manual steer and electric steer. The proper mounting method depends on the style of trolling motor.

Mounting to Electric Steer Motors

1. Position the transducer on the bottom side of the motor housing close to the center of the steering rotation.
2. Attach the transducer to the motor using the supplied cable tie.
3. Secure the cable to the lower-most part of the vertical motor shaft.
4. Run the cable through the carry handle on the motor's steering drive motor. (If your motor does not have this, you'll need to come up with an "eye" to keep the cable in place as you stow and deploy the motor)
5. Secure the cable near the motor's head at the top of the vertical shaft.
6. Route the cable down through the "coil cord" and out to your flasher's mounting location.
7. Stow and deploy the motor to insure the cable can move freely with the motor and that it cannot get pinched in any of the motor workings.

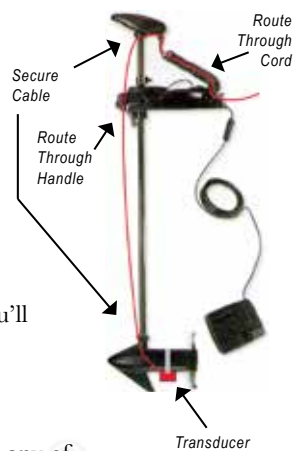

Mounting to Manual Steer Motors

1. Position the transducer on the bottom side of the motor housing close to the center of the steering rotation.
2. Attach the transducer to the motor using the supplied cable tie.
3. Secure the cable to the lower-most part of the vertical motor shaft.
4. Route the cable up the shaft, securing it every 3 or 4 inches using cable ties or electrical tape. Be sure to leave a loop near the section where the two vertical shafts meet to allow for motor rotation.
5. Route along the motor's mounting bracket and out to your flasher's mounting location.
6. Stow and deploy the motor to insure the cable can move freely with the motor and that it cannot get pinched in any of the motor working.

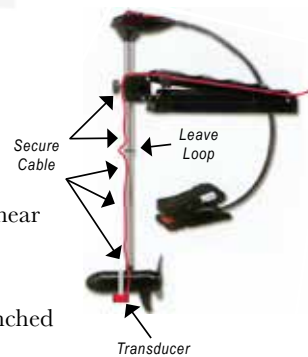

OPEN WATER OPTIONS

Universal Open Water Transducer Mounting Kit - TK-100

Year-round fishing use of any Vexilar Flasher sonar system is made a lot easier and less expensive with the Universal Open Water Transducer Mounting Kit from Vexilar. Includes a 20-degree transducer with 30 feet of cable and the mounting brackets needed to attach it to the side of a boat with a suction cup mount, an electric trolling motor mounting bracket or an external high-speed mounting bracket.



BK0044

High Speed Suction Cup Bracket

Fits all High-Speed Transom style transducers and allows for readings at speeds above the planing speed of the boat. Dual suction cups offer a secure hold.



Permanent Mount Kits

Application specific TK Kits are also available. Choose from puck style for in-hull or electric trolling motor mounting, or the high-speed style for mounting to the transom of your boat. Both transducer styles come in a variety of beam angle options.



BK0027

Fits all 2" Puck style transducers. (9°, 12°, and dual 9°/19°). Offers a secure hold and the ability to point the transducer in a specific direction.



BK0023

Fits the 1" (19°) Puck Transducer. This bracket makes it the smallest portable transducer option available.



These kits contain everything needed for installation. See page 72 for a list of kits available.



IMPORTANT: Suction cups can come loose. Each bracket includes a safety rope. Be sure to take the time to tie the rope to the bracket and then to the boat leaving as little amount of slack as you can. If the cup(s) come lose, this will keep your transducer and cable out of the propeller.

	FLX-30™BB	FLX-28™	FLX-20™	FL-18™	FLX-12™	FL-8™ SE
Display Type	Weatherproof, super-bright, 5-color LED (five color palettes).		Weatherproof, super-bright, 3-color LED (3 color palettes).	Weatherproof, super-bright, 3-color LED (strong targets in red, medium targets in orange, weak targets in green).		
Display Face	Flat screen with super wide viewing — more than one angler can see the display — and from farther away or from the sides.			Backlit scale decal with light trap design.	Flat screen with backlit scale and super wide viewing angle.	Backlit scale decal with light trap design.
Flasher Technology	Effective in 2020, All Vexilar Flashers are being produced using Vexilar's proprietary brushless data transfer technology to deliver a sunlight-readable display and less noise.					
Resolution	525 segments. Target separation of ½ inch (at 10' range setting).	525 segments. Target separation of ½ inch (at 10' range setting).	525 segments. Target separation of ½ inch (at 10' range setting).	525 segments. Target separation of 2.6 inches.	525 segments. Target separation of 1.0 inch.	525 segments. Target separation of 2.6 inches.
Target ID	Less than ¼ inch	Less than ¼ inch	Less than ¼ inch	Less than ¼ inch	1 inch	1 inch
Auto Zoom settings	6', 12' and 18' Auto Zoom.	6' and 12' Auto Zoom.	6' and 12' Auto Zoom.	6' Auto Zoom. 6' Bottom Lock.	n/a	n/a
Low power Mode	Three power mode settings: Low, Medium and High	Built-in	Built-in	Built-in	Built-in	With optional S-Cable
Night Mode	Built-in	Built-in	Built-in	n/a	Built-in	n/a
Interference rejection	20 settings per frequency (140 options)	20 settings	20 settings	10 settings	20 settings	10 settings
Depth range settings (feet)	Auto: 10, 15, 20, 25, 30, 40, 50, 60, 80, 100, 120, 160, 200, 240, 300 Shallow: 10, 15, 20, 30, 40 Medium: 50, 75, 100, 125, 150 Deep: 175, 200, 225, 250, 300	Auto: 10, 15, 20, 25, 30, 40, 50, 60, 80, 100, 120, 160, 200, 240, 300 Manual: 10, 20, 30, 40, 50	10, 20, 30, 40, 80, 100 Deep Water: 30, 60, 90, 120, 240, 300	20, 40, 60, 80, 200	20 (Low Power), 20, 40, 60, 80, 120	20, 30, 40, 60, 80, 120
Sonar longevity	MST matching sonar technology ensures maximum sonar performance and longevity by balancing the transmitter and receiver to the transducer crystal.					
Battery status	Battery status & low battery alert		Low battery alert	n/a	Low battery alert	n/a
Digital depth display	Built-in		With optional Digital Depth Indicator (DD-100)			
Operating voltage	10.5–15 volts (12 volts nominal)					
Current draw	300 mA @ 12 volts		260 mA @ 12 volts	220 mA @ 12 volts	200 mA @ 12 volts	240 mA @ 12 volts
Power output	1000 watts (peak to peak)			400 watts (peak to peak)	1000 watts (peak to peak)	400 watts (peak to peak)
Frequency	Variable 160–300 kHz		200 kHz			
Ice-Ducer™ options	Broad band Ice-Ducer™ transducer		Pro-View only	12°, 19° and Pro-View compatible.		
Dimensions	4.8"H x 6"W x 2.4"D	4.8"H x 6"W x 2.4"D	4.8"H x 6"W x 2.4"D	4.4"H x 6"W x 3.5"D	4.8"H x 6"W x 2.4"D	4.4"H x 6"W x 3.5"D
Weight	1.1 lb	1.1 lb	1.1 lb	1.1 lb	1.1 lb	1.1 lb

A TRADITION OF EXCELLENCE AND KNOWLEDGE TO SHARE WITH FRIENDS AND FAMILY!

For over a half a century, anglers have started many great fishing adventures by turning on a Vexilar. Now with over a half million Vexilar units in use today, it's no wonder serious anglers proudly state:

“They will never go fishing without their Vexilar!”

This Owner's Manual is to serve as a foundation of knowledge to get you started using your Vexilar. Reading the sections of this manual that applies to your system will avoid confusion and actually go a long way in helping you extend the life of your Vexilar product as well.

They often say: “Knowledge is power” and with the knowledge from this manual we hope you will share with other Vexilar owners who were not as pro-active enough to read about how to get the most out of their Vexilar. From the tricks on how to adjust your gain level to how to properly use the Interference Rejection system all to make for a more enjoyable day on the water.

It might seem simple, but it is the little things that many anglers overlook when they are in a rush to get out on the water. We thank you for taking the time to study and learn about your Vexilar system, and we hope you can also share your new-found knowledge with your friends.

FL-8[®]SE OPERATION

The FL-8[®]SE is today's refinement of the famous original Vexilar FL-8. This model was instrumental in the modern ice fishing transformation. With the advent of reliable light-weight power ice augers, highly mobile quick-setup shelters and the infamous "Vexilar" to let you see your bait as well as the fish, the sport made a huge leap forward in the early 1990s, in both effectiveness and popularity. Gone were the days of sitting on a bucket and waiting for the elusive bite. Your new FL-8[®]SE is truly a part of this history.



22

GP0819

FL-8[®]SE Range Setting

The FL-8[®]SE has six depth ranges in two groups, Shallow and Deep. The shallow range group includes Zero to 20', 40', and 80'. The deep range group includes Zero to 30', 60', and 120'. To interpret depth, you multiply the displayed reading by the range multiplier.

The FL-8[®]SE comes in only the Genz Pack configuration.

FL-8[®]SE OPERATION



*Shallow Range Group
Look at the outer scale and the
left-hand multipliers in white*

*Deep Range Group
Look at the inner scale and the
right-hand multipliers in yellow*

Transducer

The FL-8[®]SE comes standard with a 19° Ice-Ducer transducer. This is the widest beam angle available. You may also purchase additional transducers with narrower beam angles and/or for boat-mounted applications. (see pages 72-73)

Gain Control

Turn the Gain Control clockwise to increase the gain. Keep the gain as low as possible. The Gain Control also serves as the ON/OFF switch for the Interference Rejection feature by pushing in on the control. You will see the red light go off.

Depth Scales

Shallow Range Group

- S-1: Zero to 20 feet. Read the outer white scale directly.
- S-2: Zero to 40 feet. Read the outer white scale and double the reading.
- S-4 : Zero to 80 feet. Read the outer white scale and multiply by 4.

Deep Range Group

- D-1 = Zero to 30 feet. Read the inner yellow scale directly.
- D-2 = Zero to 60 feet. Read the inner yellow scale and double it.
- D-4 = Zero to 120 feet. Read the inner yellow scale and multiply by 4.

Interference Rejection

Interference Rejection comes on automatically when you power up the flasher. If interference from another sounder is present on the display, push the Rejection button repeatedly until it goes away or is reduced as much as possible. There are 10 settings to cycle through.

23

FLX-12 OPERATION

This unit is a step-up from the classic FL-8®SE unit. The FLX-12 offers a flat-screen design plus some additional features. This unit has a special Low Power Mode option that allows you to fish in extremely shallow water with great target resolution. Five depth ranges to 120 feet. The FLX-12 offers a unique Night Mode option so the display is easier to view at night and also lights up the center depth graphics. There are 20 steps of Interference rejection (IR) to help knock-out interference from other sonar systems. If your battery is running low, the display gives a coded series of flashes long before the unit shuts down. The FLX-12 is VERY popular for open water use because of its flat screen display that won't trap water and offering great sunlight display visibility.



GPX1212

IPX1212

24

Low Battery Indicator

The FLX-12 series units will give the angler a low battery warning (10.6 volts) by flashing the green depth lines around the inner side of the display 4 times every four minutes. At 8 volts, the green depth lines will flash all the time just before the system shuts down completely (6.5 volts). All batteries are different and how long you are able to fish after the first warning will vary. Also, this feature is designed for SLA type batteries.

Vexilar Lithium battery voltage drops much faster than SLA batteries at the end of the discharge cycle. Therefore, expect the battery to die very soon after the first low battery indications are given.

FLX-12 OPERATION



Gain Control

Keep the gain low. Increase it only enough to see clear bottom or your bait.

Night Mode

Push in on the Gain Control to dim the lights of the display for night use.

Interference Rejection

Press the button repeatedly until the interference goes away or is reduced as much as possible. There are 20 settings to cycle through.

Range Setting

The FLX-12 has a maximum display range of 120 feet, with five depth ranges starting at the 20 on the 0-20 scale that is marked on the front dial.

Depth Scales

As you move deeper to find bottom, you will need to do a little math. The x2 setting means the dial is now displaying a 0-40 foot scale, the x3 is a 0-60 foot scale the x4 is 0-80 the x6 is 0-120. The 20' Low Power (LP) range reads the same as the standard 20 foot range, except using this selection puts the flasher into Low Power Mode.

25

FL-18 OPERATION

The FL-18 offers a patented split-screen flasher display. This allows you to both zoom-in on the bottom six feet on the left side of the screen while watching the entire water column in real time on the right side. The Bottom Lock feature stays locked on the bottom even as the boat is bouncing up and down in big waves. The Auto Zoom Mode is fantastic for watching perch or walleye while ice fishing. The FL-18 is equipped with features like a built-in Low Power Mode for fishing waters under 20 feet. Five depth scales down to 200 feet, plus 10 interference rejection settings.



GP1812

PP1812D

26

See pages 58 - 63 to learn more about ice pack features.
*DD-100 not included with some packages

FL-18 Modes

The Mode Control is divided left to right by power output. Starting with the switch turned fully left:

LP > BL: Low Power Bottom Lock Mode

This mode locks the position of the bottom on the zoom side and uses a lower power output. It's great for wavy lake fishing in shallow water. Do not use it for ice fishing.

LP > AZ: Low Power Auto-Zoom Mode

This mode splits the screen into Zoom Mode and uses a lower power level. Use this in deeper weedy or turbulent waters.

LP: Low Power Mode

This mode uses the standard display, but at the lower power setting. Use this mode in shallow or weedy waters.

NORM: Normal Mode

Normal Mode uses full power and the full display. Use this for normal viewing and for a reliable starting point.

AZ: Auto Zoom Mode

This mode splits the screen into Zoom Mode at normal power. Use this mode for normal ice fishing conditions in deeper waters.

BL: Bottom Lock Mode

This mode locks the position of the bottom on the zoom side. It's great for wavy lake fishing. Do not use it for ice fishing.

FL-18 OPERATION



Gain Control
Keep the gain low. Increase it only enough to see clear bottom, or your bait.

Interference Rejection
Press the Gain Control repeatedly until it goes away or is reduced as much as possible. There are 10 settings to cycle through.

Mode Control
(Normal Mode selected)

Range Setting

The FL-18 has 5 depth ranges. Zero to 20', 40', 60', 80', and 200'. To interpret depth, you multiply the displayed reading by the range multiplier.

Depth Scales

In Normal Mode, read the outer white scale and multiply by the range setting. Here, the range is set to "x1". Bottom is at 15 feet, a fish is at 12 feet, and there is a weak signal at 10 feet. If the Range Control was set to "x2", the bottom would be interpreted as 30 feet, the fish at 24 feet, and the green mark at 20 feet.

27

Auto Zoom

The Zoom scale reads in the opposite direction as the full view scale. The bottom will always be at the 7 O'clock position. Objects will appear above this point. You can only see objects as far off the bottom as the zoom setting permits, which is 6 feet. Objects above this level will only appear on the right side, which shows the entire water column.

Activate Auto Zoom by switching the Mode Control to the AZ selection on the right or the left. The right selection operates Auto Zoom at the normal power level. The left selection operates Auto Zoom in Low Power Mode.

THE LEFT HALF represents the zoom view. From the bottom up to six feet. Read the distance from the bottom using the inner yellow scale.

THE RIGHT HALF represents the entire water column, from the water surface to the bottom. Read the depth using the inner yellow scale.

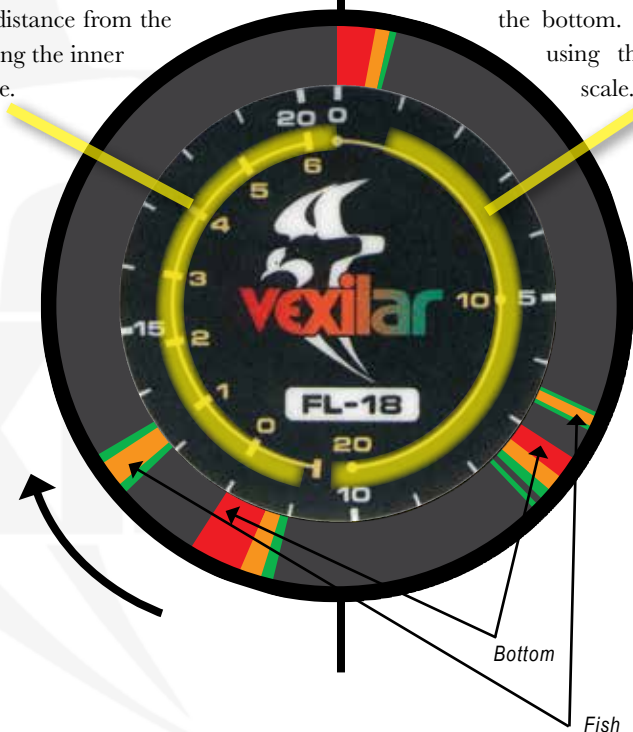

Bottom Lock Zoom

Bottom Lock (BL) works the same as Auto Zoom, except the flasher continuously updates the position of the bottom in the magnified view. This can be helpful in a boat that is moving over varying depths or is riding in heavy waves. Bottom Lock will keep the bottom reading lined up correctly with the zero mark on the Zoom scale. This allows you to see objects which are very close to the bottom, even though the depth may be changing rapidly. The Range Control must be set to a position where the bottom is displayed on the right in order for Bottom Lock to function.

FL-18 Bottom Lock (BL)

Activate Bottom Lock by switching the Mode Control to the BL selection on the right or the left. The right selection operates Bottom Lock at the normal power level. The left selection operates Bottom Lock in Low Power Mode.



For Boat Use Only

Bottom Lock works best for boats in motion. When ice fishing, the Bottom Lock feature can incorrectly identify a large object slowly moving into your view as a shallower depth change. The result is that the flasher adjusts to the new level and the object is now displayed as the bottom.

Understanding the Zoom Modes

When Auto Zoom (AZ or BL) is active, the display is divided into two halves. When reading depths always use the yellow inner scale on the right side.

Zoom should be activated only when the transducer is submerged. If the zoom is activated before the transducer is placed in the water, such as when moving from ice fishing hole to hole while the zoom is operating, the bottom may not line up with the zero mark on the zoom scale correctly. If this happens, switch the flasher to Normal Mode and then back to Zoom to reset the feature.

Low Power Mode

LP Mode reduces the output power of your flasher. It is useful for situations where the gain cannot be turned down enough in Normal Mode. Use the Low Power Mode only when you need to. You will use it in only very shallow or very weedy conditions. Activate the Low Power Mode (LP) by switching the Mode Control to the left. The range can be set at any position. If you switch to the left of LP, you can activate the 6' AZ or 6' BL Modes in Low Power Mode.

FLX-20 OPERATION

Versatility is the key to success and the FLX-20 delivers! With two Auto Zoom zone options, one for the zooming in on the bottom six feet and one for the bottom twelve feet, there is nowhere those bottom loving fish can hide. From the 300 foot max depth range to the Night Mode for easy viewing in low light conditions, nothing rivals the FLX-20 for superior, multi-use performance, shallow or deep, day or night.



GPX2012



PPX2012D

FLX-20 Demo Mode

The FLX-20 incorporates a Demo Mode, so you can see the display work in your home, as you read this manual. To turn on Demo Mode, set the Mode Control to Normal, rotate the Gain Control to Maximum, then press in and hold the Gain Control while you power ON the unit.

FLX-20 OPERATION



Gain Control

Keep the gain low. Increase it only enough to see clear bottom, or your bait. The Gain Control also acts as a feature select switch when you push in. See next page

Mode Control

Control advanced features, such as zoom, power and color. See next page.

Interference Rejection

Press the Gain Control repeatedly until it goes away or is reduced as much as possible. There are 20 settings to cycle through.

Color Select

While the Mode Control is set to CS, push on the Gain Control to cycle through the three color palettes See page 34.

Setting the Range

The FLX-20 has a total of 11 depth ranges to allow you to get maximum display resolution for the fishing conditions you are in. The primary ranges for the FLX-20 will be in the normal settings starting with 0-10 feet.

The x2 setting will mean you will need to double the depth on the display so you now have a 0-20 foot display, the x3 is 0-30, the x4 is 0-40, x8 is 0-80 foot and x10 will mean a 0-100 foot scale. You can also activate the other set of depth settings for super deep water fishing to 300 feet. See the next page for instructions.

Mode Control

Control advanced features, such as Zoom, power and color.

CS > Color Select Mode

Use this mode when you need to adjust the color palette. The FLX-20 will keep your choice even after you turn the unit off. See page 34

LP > AZ: Low Power Auto-Zoom

This mode splits the screen into Zoom Mode and uses a lower power level. Use this in deeper weedy or turbulent waters.

LP: Low Power

This mode uses the standard display, but at the lower power setting. Use this mode in shallow or weedy waters.

NORM: Normal Mode

Normal Mode uses full power and the full display. Use this for normal viewing and for a reliable starting point.

AZ: Auto Zoom

This mode splits the screen into 6' Zoom Mode at normal power. Use this mode for normal ice fishing conditions in deeper waters.

AZx2: 12' Auto Zoom

This mode splits the screen into 12' Zoom Mode at normal power. Use this mode for normal ice fishing conditions where the fish are higher off the bottom than 6 feet.

Deep Mode

To activate the 300' Deep water ranges: Turn gain setting to "1" press in and turn the unit on at the same time. This essentially triples the standard depth ranges. Now the display will start out at the 0-30 foot range, the x2 is 0-60, the x3 is 0-90, the x4 is 0-120, the x8 is 0-240 and the x10 setting is a 0-300 foot display on the dial.

Turning the unit OFF will revert the ranges back to normal.

KNOW YOUR DEPTH! The 0-10 foot scale allows for an easy system to get your depth reading. If the signal says your bottom is at 6, you then simply look to see where your Range Control is set to and do the simple math. If you are on the x3 setting, then it is 6x3, or 18 feet it's that simple!

IMPORTANT

Zoom should be activated only when the transducer is submerged. If the zoom is activated before the transducer is placed in the water, such as when moving from ice fishing hole to hole while the zoom is operating, the bottom may not line up with the zero mark on the zoom scale correctly. If this happens, simply switch the flasher to Normal Mode and then back to Zoom to reset the feature.

Auto Zoom

Auto Zoom (AZ) puts the flasher into a split-screen view, with the complete water column on the right and a magnified view from the bottom up on the left. When you switch to Auto Zoom Mode, the flasher automatically selects the magnified bottom view for you, provided the flasher is set to a depth range in which the bottom is in view. There are two Auto Zoom modes; 6 foot and twelve foot.

The Zoom scale reads in the opposite direction as the full view scale. The bottom will always be at the 7 O'clock position. Objects will appear above this point. You can only see objects as far off the bottom as the zoom setting permits, either 6 feet or 12 feet. Objects above this level will only appear on the right side which show the entire water column.

THE LEFT HALF represents the zoom view. From the bottom up to 6 or 12 feet. Read the distance from the bottom using the large white scale.

THE RIGHT HALF represents the entire water column, from the transducer to the bottom. Read the depth using the inner white scale.

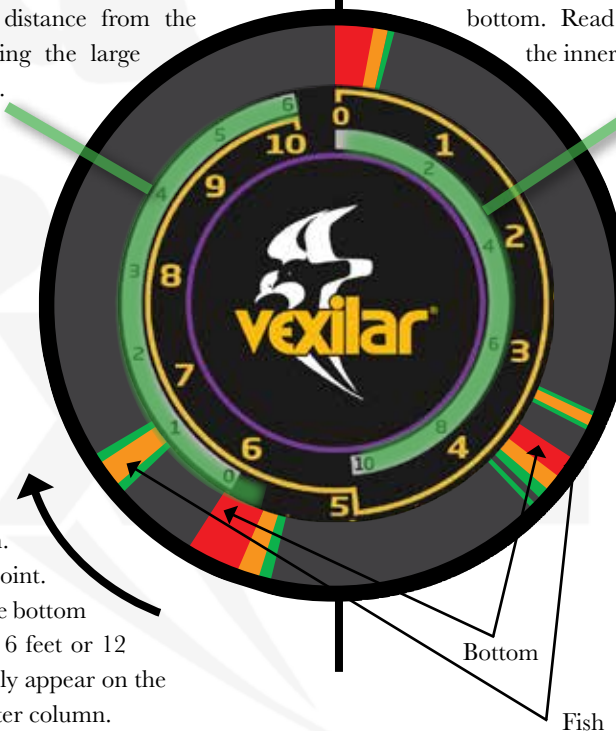

You interpret the depth by multiplying the indicated value on the white scale by the multiplying factor here.

- 10' Range = 10
- 20' Range = x2
- 30' Range = x3
- 40' Range = x4
- 80' Range = x8
- 100' Range = x10

FLX-20 Low Power Mode

Low Power Mode, or LP Mode, reduces the output power of your flasher. It is useful for situations where the gain cannot be turned down enough in Normal Mode. Low Power Mode has two view settings, Full Display Mode and Auto-Zoom Display Mode. Use the Low Power Modes only when you need to. Usually, you'll use it in only very shallow or very weedy conditions.

Activate the Low Power Mode by switching the Mode Control from to the left. The first Low Power Mode provides a normal view. The LP-AZ Mode places the unit in the split-screen 6' Auto Zoom Mode and Low Power

FLX-20 Color Select

On the Mode Control you have the "CS" option on the switch, this stands for "Color Select." Simply switch the Mode Control to CS and then push in the top Gain Control while the flasher is on. The FLX-20 display will tell you what color setting you are selecting from scheme 1 through 3.

Color Mode 1: Classic Vexilar - Red, Yellow, Green

In this application, green shows you the weakest signals below you. Commonly weeds are shown in green and even your lure sometimes would be shown as green. If you turn up the gain setting, that same green signal will change to yellow or maybe even red. Yellow is the next strongest signal and then red, which will be on your display at the zero mark and again to show you bottom.

Color Mode 2: Red, Yellow Only

The more you use a Vexilar, the more you are confronted with situations where you will often be seeing a lot of green in your display. Heavy weeds, for example, or in some lakes where tiny bugs are so thick on a lake at night they trigger a green cloud on your display. By taking out the green, you take out much of the confusing signals that you normally have to fish around. In this setting, your lure will be yellow and you will notice that fish will "suddenly appear" more, since the weaker green signal is no longer there to alert you of a fish on the outer edge of your coverage.

Color Mode 3: Red Only

This color palette will show the cleanest display and only the strongest signals and is best for when you are only interested in depth or navigation.

FLX-20 Night Mode

Night Mode reduces the brightness of the display. This can make viewing more comfortable in low light conditions. To activate Night Mode, push in and hold the Gain Control until the brightness changes. When you power off the FLX-20, it will revert to normal full brightness.

Low Battery Indicator

The FLX-20 will give the angler a low battery warning (10.6 volts) by flashing the green depth lines around the inner side of the display 4 times every four minutes. At 8 volts, the green depth lines will flash all the time just before the system shuts down completely (6.5 volts). All batteries are different and how long you are able to fish after the first warning will vary. Note that this feature is designed for SLA type batteries.

Vexilar Lithium battery voltage drops quickly at the end of the discharge cycle. Therefore, expect the battery to die very soon after the first low battery indications appear.

FLX-28 OPERATION

Features, performance and ease of use make fishing with the highly advanced, yet very user-friendly FLX-28 a pure joy. Based on Vexilar's exclusive brushless data transfer technology, the FLX-28 delivers the industry's finest display. The sunlight-readable display offers five different color palettes and shows digital depth. The magic of the FLX-28 is the auto feature. Simply place the Ice-Ducer transducer in the water, turn the system on and start fishing! The unit automatically selects the proper interference rejection and depth range to give you maximum display resolution down to 300 feet. The FLX-28 is packed with additional features such as Weed Mode, Night Mode and auto zoom that make it one of the most popular sonar systems on the ice today.



36

FLX-28 OPERATION



Gain Control

Keep the gain low. Increase it only enough to see clear bottom, or your bait. The Gain Control also acts as a feature-select when you push in. See next pages

Mode Control

Control advanced features, such as zoom, power and color. See next pages.

Setting the Range

The FLX-28 is equipped with a digital depth readout on the inner display dial and the "AUTO" stands for "Auto Range". You can also select ranges manually.

Interference Rejection

Press the Gain Control repeatedly until it goes away or is reduced as much as possible. There are 20 settings to cycle through.

Weed Mode

Set the Mode to Normal. Then push in on the Gain Control while powering-on the unit to enter Weed Mode.

Color Select

While the Mode Control is set to CS, push on the Gain Control to cycle through the different color palettes. (see page 56)

The "AUTO" setting automatically selects the correct depth range to maximize your display area. The shallowest range in the Auto setting is 0-10 feet. For example, if you are fishing only 8 feet of water, in the "AUTO" Mode setting, the entire dial of the display will be dedicated to 10 feet or less. To override the AUTO feature, simply change the Range Control to the desired depth setting. The digital display on the inner dial of your Vexilar will display your current digital depth and also the current range you are in. So your display will read: Depth 17 ft – R-20 (for Depth Range = 20 feet).

37

Auto Range Operation

As the name implies, Auto Range automatically selects the proper range for you. However, it is not infallible. It is possible to confuse your "Auto Range" operation when fishing over very soft lake bottoms or during conditions of thick ice. This can confuse the software, as it cannot find a bottom point in the return signal strong enough to trigger a lock on the bottom. For this reason, there is a three second delay beginning when you put the transducer in the water before the unit attempts to lock. This gives the software time to process the signal it is seeing to best determine the true bottom point.

When soft bottom conditions exist, you may need to turn up your gain initially to help enable the program to find bottom. Then you can turn the gain back down when fishing. If you find your Auto setting cannot lock on bottom, the range setting will default to the 300' range. You can then simply switch to a Manual Range option.

NOTE: There is nothing wrong with your Vexilar if it cannot lock on a range automatically. This is a very unique fishing scenario. Try switching to Normal Mode, which is full power, and then select a manual range. Also note that the digital depth is disabled in Low Power Mode.

Low Power Option

The Low Power Mode is designed for shallow water anglers looking to clean up a cluttered and busy display. The rule for using the Low Power Mode setting is this: If you turn down your gain as low as it can go in Normal Mode, and yet the signal is still too strong to get a good clean reading, switch to the Low Power Mode. By activating the LP Mode you are greatly reducing the output power of your unit.

This means you should expect the lure, fish or weeds below to disappear if your gain remains at or near zero. You will now need to turn up the gain to "fine-tune" your display. You **DO NOT** want to be in LP all the time since it will make finding a lure or even fish in deeper water nearly impossible. Only use this mode when needed. Also, when trying to fish in deeper water you will need to turn up your gain, but if too high, interference from other sonar systems can make it impossible for you to fish. In keeping with the golden rule for Gain Control: keep your gain as low as possible in order to still see your bait, if the lowest gain setting is not low enough, then switch to LP Mode.

NOTE: The unit must be in manual range setting to use Low Power option. The Digital Depth reading, Auto Ranging and the AZ or Auto Zoom Feature **WILL NOT** work reliably while in LP or Low Power setting.

FLX-28 - Auto Zoom

THE LEFT HALF represents the zoom view from the bottom up to 6 or 12 feet. Read the distance from the bottom up using the green depth markers.

THE RIGHT HALF represents the entire view from the bottom up to 6 or 12 feet. Read the distance from the bottom up using the green depth markers.

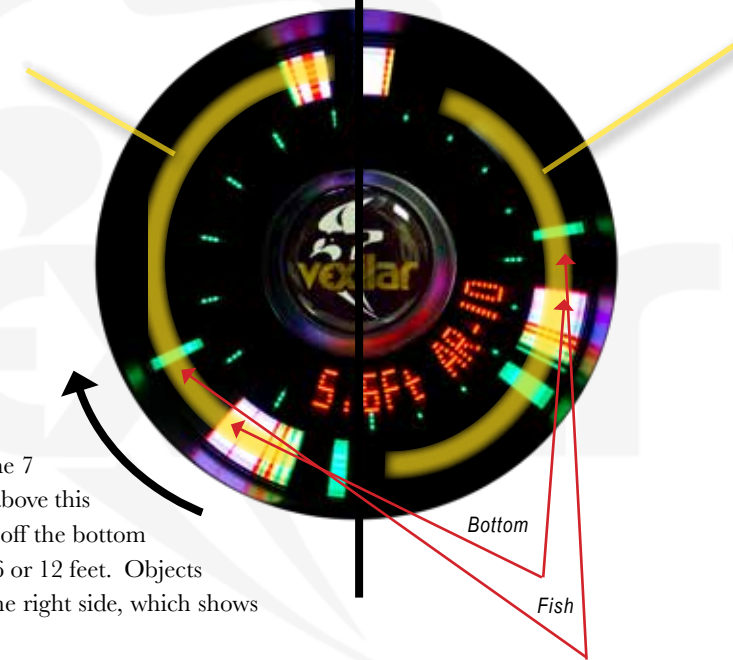

The zoom scale reads in the opposite direction as the full view scale. The bottom will always be at the 7 o'clock position. Objects will appear above this point. You can only see objects as far off the bottom as the zoom setting permits, which is 6 or 12 feet. Objects above this level will only appear on the right side, which shows the entire water column.

See page 42 for more information about Zoom



Multi-Layer Display

The FLX-28 incorporates a three-layer LED, spinning wheel display. The outer color display layer is like our standard three-color Vexilar flasher display. However, with data transfer technology, we can offer more color palettes.

The inner layer gives you a green marker for every foot shown on the display. This makes it easy to position your baits one or two feet off the bottom without guessing. As you change depth ranges, the line counts for each display will correspond to the depth changes as shown in the table.

The third inner layer of the display will be in red, where you find your Digital Depth and Range settings. This area is also used to display battery levels, IR setting levels and your Mode settings.

Color Select

The FLX-28 includes 5 optional color palettes to choose from. Set the Mode Control to the CS position, then press in on the Gain Control to cycle through the available palettes. See page 56 for an explanation of each.

Foot Markers	Range Settings
1ft	10 - 30ft
5ft	40 - 60ft
10ft	80 - 300ft

Weed Mode

The Weed Mode option can be used in any situation where you want to sharpen individual target separation. Most often this occurs in thick weeds where you will want to avoid seeing the weed stalks as blobs so you can see your lure moving inside a tall weed bed. It also is helpful when you are fishing in schools of panfish or balls of shad.

To activate this feature, you need to be in the Normal Mode setting with the gain set to zero. Turn the unit "ON" while holding down the Gain Control. Once turned on, all features of your FLX-28 will work normally, but you will notice your display to be slightly weaker. You may need to increase your gain level. It's possible to use the Weed Mode when you're in the Low Power Mode. However, you still need to go through the Weed Mode process first.

From a technical standpoint, you are sending a shorter transmit burst, which requires more sensitivity from your receiver. That is why you need to turn up your gain. The limitations of this technology means it is best to use in 30 feet of water or less and in areas where interference from other anglers will not be a problem, since you will need to use a higher gain setting which will make it more sensitive to receive interference. When you turn your unit off, it will re-set back to Normal Mode.

LP Mode & Open Water Use

The Digital Depth display is disabled in Low Power Mode and Auto-Ranging may be inconsistent. This is because accurate digital depth readings cannot be maintained when running in this mode.

Because the Auto Range technology was designed specifically for an ice fishing environment, it is recommended to use Manual Range settings for open water use. Note that while in the Manual Range settings the digital depth readout will only display up to 50 feet. If you lose the digital bottom depth reading in a known area of less than 50 feet of water, or it does not seem to match with what the flasher display is reading, these factors may come into play:

1. Very Soft Bottom
2. Too many fish (Depth readings will jump up and back to bottom as fish pass)
3. Too Much Vegetation
4. Your actual depth may be deeper than the current range selected (Shift to 50 foot manual range)

NOTE: When fishing in very shallow water, you will see that the FLX-28 will not register a digital depth readout when you are in waters shallower than 3 feet.

Auto Zoom Modes

When you shift to the AZ 6 Mode, you are splitting your display in half and dedicating the right side of the display to the entire water column, while the left side is dedicated to just the bottom 6 feet of the water column. If you are a perch angler fishing in 40 feet of water, you can zoom in on the bottom 6 feet of the water column to greatly increase your visibility in this zone. Similarly, in the AZ x2 setting, you are viewing the bottom 12 feet of the water column.

IMPORTANT: Both AZ6 and AZ x2 should never be used in open water scenarios. Also note that even if you are in the Auto Range setting, you will need to manually re-set the AZ view by shifting to normal and back to AZ when you change depths. Also note that if the bottom is very soft, you may need to switch to Normal Mode, increase the gain setting, then switch to back to AZ in order to lock on the top of the soft bottom. You can then simply back down your gain and fish as usual.

FLX-28 Battery Voltage Display

Each time you turn the FLX-28 unit on, it will flash the voltage of your battery on the digital display for three seconds. The FLX-28 can work on any 12 volt power supply. While fishing if you

find the digital display saying “LOW-BATT” the system is telling you the battery is down to only 10.6 volts. At 8.0 volts, the “LOW-BATT” graphic warnings will start to blink on and off which tells you the unit is about to shutdown. At 6.5 volts the entire display will blink on and off and then shut down completely. Be sure to charge your battery often to avoid any down time fishing without your Vexilar at full capacity.

Battery Voltage	Percent Charge
12.7	100%
12.5	80%
12.3	70%
12.0	60%
11.9	50%
11.7	40%
11.6	30%

Lithium battery voltage drops faster than SLA batteries at the end of the discharge cycle. Therefore, expect a lithium battery to die very soon after the first low battery indications appear.

FLX-28 Day & Night Modes

Night fishing in the winter months is very popular. The problem with the bright display of the FLX-28 is that at night many find the display too bright and uncomfortable on the eyes. Simply press in and hold the Gain Control for three seconds. The brightness of the unit will be reduced by 50%.

Demo Mode

Here is a fun feature that the FLX-28 offers to those dreaming about ice fishing during the off season or when they are coaching their friends on what to expect when they go fishing with ANY Vexilar. The Demo Mode simply runs a simulation program showing what a bottom signal will look like in Normal Mode setting. You will see a fish target near the bottom and on the right side of the dial, you will see the lure dropping down or moving around the dial right to left. As the lure nears six feet from the bottom, the unit shifts to AZ Mode display which zooms in on the bottom six foot of the water column. Note how much larger your lure and the fish appear in the AZ setting. The lure stops just above the fish target and the lure is jiggged up and down to trigger the fish to move up to eat it. Then the fish comes to the bait and is caught. Just like it happens in real life!

Your unit only needs to be on and turned to the “D” setting on the Mode switch. All other controls will be deactivated at this point. The system will show a different color display option with each cycle of the Demo Mode so you can see what color palette you like the best even before you get on the ice.

FLX-30^{BB} OPERATION

Vexilar has delivered on the dream of developing a broad band flasher sonar with unmatched interference rejection and signal clarity. Based on the same performance platform as the FLX-28. The FLX-30 now offers the angler seven frequencies from which to choose. With 20 IR settings for each frequency, this gives you 140 combinations to kill interference once and for all!

Broad Band Sonar

The FLX-30's Broad Band, Ice-Ducer™ is made from an array of dozens of small transducer crystals. They deliver a wide sonar frequency band from a 15-degree beam at 160 kHz to an 8-degree at 300 kHz. Anglers can fine-tune the display to knock-out interference and sharpen target ID down to 1/4".

The FLX-30 features Night Mode, three power level settings, three zoom zones, three manual depth setting ranges to 300 feet and five color palette choices. With Vexilar's legendary sunlight-readable, 525-segment resolution display now enhanced with Broad Band technology, it is safe to say you will never look at ice fishing the same again.

44

FLX-30^{BB} OPERATION



Gain Control

Keep the gain low. Increase it only enough to see clear bottom, or your bait. The Gain Control also controls a number of other features. See the next pages.

Mode Control

This sets the FLX-30's current operating mode. See next pages.

Setting the Range

The FLX-30 is equipped with a digital depth readout on the inner display dial and the "AUTO" stands for "Auto Range". You can also select ranges manually.

The Auto setting automatically selects the correct depth range to maximize your display area. The shallowest range in the Auto setting is 0-10 feet. For example, if you are fishing only 8 feet of water, in the Auto Range setting, the entire dial of the display will be dedicated to 10 feet or less. To override the Auto feature, simply change the Range Control to the desired depth setting. The digital display on the inner dial of your Vexilar will display your current digital depth and also the current range you are in. So your display will read: Depth 8.9 ft – AR-10 (for Auto Range = 10 feet).

45

FLX-30BB OPERATION

Basic Concept

Most sonar systems sold today use a frequency of 200 kHz. This has been a well-accepted frequency by most anglers and boaters for over 40 years. While not perfect, the 200 kHz is well suited to getting sonar depth readings down to 300 feet, even though most are actually used in waters under 40 feet.

Sonar designers fully understand the limitations of a single frequency system, but the option for offering several frequencies in a single system was so expensive that it was not a commercially viable option, until the development of the Broad Band transducer. For the first time, a composite crystal could be made from an array of small crystals interconnected into one compact housing. The result is to deliver a wide spectrum of sonar frequencies in one transducer.

No one frequency is “perfect” for all situations, but the seven frequencies found in the FLX-30 give some great options for serious anglers looking for the best possible performance from a single sonar device. Now, when fishing 300 feet of water, the angler can use a powerful 160 kHz signal, but later adjust to a higher 300 kHz transmit frequency when fishing in only 5 feet of water. So you now have the option to adjust frequencies and power levels to give you the finest sonar response possible for a given fishing situation.

START Mode

Before turning on the FLX-30, adjust the Mode Control to the “S” or START position. This will give you easy access to begin the day using popular factory settings. You will learn it is possible to customize the performance of the unit, in many ways. This mode setting makes it easy to start fishing a new lake, or if you wish to remove past settings and start over. The “S” mode factory settings will perform well in nearly all fishing situations.

START Mode Factory Setting

Zoom:	OFF	<i>If the bottom cannot be found,</i>
Frequency:	200kHz	<i>you are most likely not getting a</i>
Power:	High	<i>strong enough signal to establish</i>
Range Range	Shallow	<i>a bottom reading. The display</i>
Color Palette:	#3 (see page 56)	<i>will ask you to switch to</i>
		<i>Manual Depth Range</i>

With the Range Control set to Auto, when powering the unit on you may see the word “Searching“ for up to 8 seconds. The system is looking for the bottom to establish the best depth range and Interference Rejection setting for you. Once the depth is found the digital depth reading and the proper range setting will be displayed at the bottom of the display.



FLX-30BB OPERATION

Mode and Gain Controls

The Mode and Gain controls work in conjunction with each other. You first select the Mode, then push in on the Gain Control to cycle through the Mode’s options. The display will show you the current setting.

Mode Settings and Options

Zoom (Z): This mode allows you to cycle the Auto Zoom setting between the available zoom ranges; 6’, 12’, 18’ and OFF.

Frequency (F): This mode allows you to control the FLX-30’s Broad Band setting. Cycle through these frequencies: 160, 180, 200, 225, 250, 275 & 300 kHz (see next page)

Power (P): This mode allows you to choose the output power mode.
Choose from: Low, Medium and High

Range (R): Auto Range: 10, 15, 20, 25, 30, 40, 50, 60, 80, 100, 120, 160, 200, 240 and 300 feet
Shallow Range Group: 10, 15, 20, 30 and 40 feet
Middle Range Group: 50, 75, 100, 125 and 150 feet
Deep Range Group: 175, 200, 225, 250 and 300 feet

Color (C): This mode allows you to choose the color palette you like best. (see page 56)
C Mode also allows for Night Mode activation. (see page 53)

FLX-30BB OPERATION



Multi-Layer Display

The FLX-30 incorporates a three-layer LED, spinning wheel display. The outer color display layer is like our standard three-color Vexilar flasher display. However, with data transfer technology, we can offer more color palettes.

The inner layer gives you a green marker for every foot shown on the display. This makes it easy to position your baits one or two feet off the bottom without guessing. As you change depth ranges, the line counts for each display will correspond to the depth changes as shown in the table.

The third inner layer of the display will be in red, where you find your Digital Depth and Range settings. This area is also used to display battery levels, IR setting levels and your mode settings.

Frequency vs Beam Angle

Each frequency will have a different beam angle. The lower the frequency, the wider the area of coverage.

Foot Markers	Range Settings
1ft	10 - 30ft
5ft	40 - 75ft
10ft	80 - 300ft

Frequency	Beam Angle
160kHz	15°
180kHz	13°
200kHz	12°
225kHz	10°
250kHz	9°
275kHz	8.2°
300kHz	7.8°

FLX-30BB OPERATION

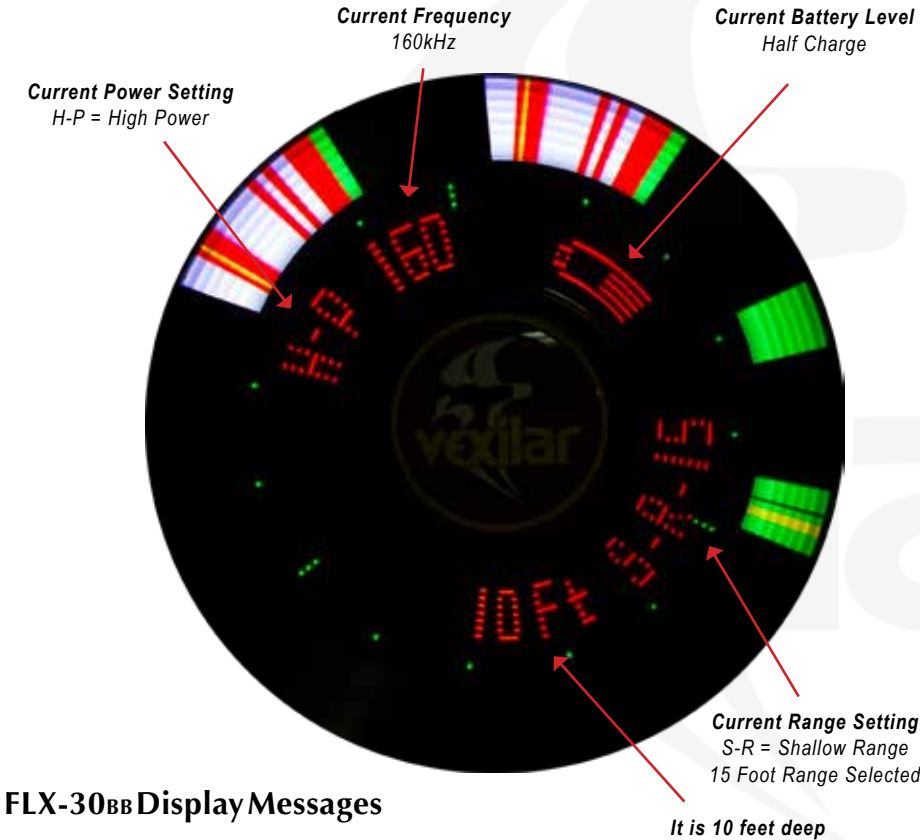

FLX-30BB Display Messages

Message Meanings

SEARCHING

The FLX-30 is adjusting to the proper range.

USE MANUAL RANGE

The FLX-30 cannot lock on the bottom.

LOW BAT

The battery voltage is getting low. Expect the FLX-30 to stop working soon once the LOW BAT message begins flashing.

Power Level

HP = High Power
MP = Medium Power
LP = Low Power

Range Options

S-R = Shallow Range
M-R = Middle Range
D-R = Deep Range

FLX-30BB OPERATION

Setting the Frequency

The FLX-30 Broad Band sonar has the ability to output a frequency that is best for your specific fishing situation. The “F” on the Mode Control stands for “frequency”. Set the Mode to F and then push in on the Gain Control to change the frequency.

The standard rule with frequency is; the lower the frequency, the wider the beam angle, and the higher the frequency the narrower the beam angle. If you feel the display has too much clutter, interference, signal size too large, or you start seeing strange things floating in the water like freshwater shrimp, zoo plankton or even thermal stratification in the water column, cycle your unit through the 7 frequency options to see if you can improve the view. You will see the current frequency selected located in the 11 o'clock position on the main dial just to the right of the Power setting display.

Expect to adjust the Gain level to maximize the performance of each frequency. With the standard 200 kHz system Vexilar users like to keep their gain super low at all times, but you may find that a higher gain setting is required, the higher the frequency selected.

50

Auto Range Operation

Auto Range automatically selects the proper range for you. However, it is not infallible. It is possible to confuse your “Auto Range” operation when fishing over very soft lake bottoms or during conditions of thick ice. This can confuse the software, as it cannot find a bottom point in the return signal strong enough to trigger a lock on the bottom. For this reason, there can be an 8 second delay beginning when you put the transducer in the water before the unit attempts to lock. The display will show SEARCHING as it processes the signal to best determine the true bottom point.

When soft bottom conditions exist, you may need to turn up your gain initially to help enable the program to find bottom. Then you can turn the gain back down when fishing. If you find your Auto setting cannot lock on bottom, the display will request that you switch to a manual range. Turn the Range Control to the right until you see the bottom appear. Also, switch to High Power.

NOTE: There is nothing wrong with your Vexilar if it cannot lock on a range automatically. This is a very unique fishing scenario. Try switching to 200kHz, a manual range or moving to a new location. Also note that the digital depth may be unreliable in this type of condition.

FLX-30BB OPERATION

FLX-30BB - Auto Zoom

THE LEFT HALF represents the zoom view from the bottom up to 6, 12 or 18 feet. Read the distance from the bottom up using the green depth markers.

THE RIGHT HALF represents the entire water column from the transducer to the bottom.

Green hash marks will appear every foot on the left side.

The zoom scale reads in the opposite direction as the full view scale. The bottom will always be at the 7 o'clock position. Objects will appear above this point. You can only see objects as far off the bottom as the zoom setting permits, which is 6, 12 or 18 feet. Objects above this level will only appear on the right side, which shows the entire water column.

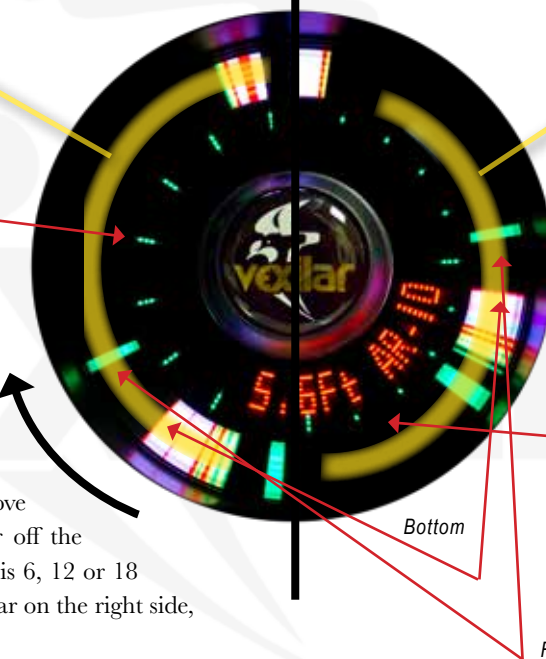

Green hash marks will appear every foot on the right side to depths of up to 30 feet, every five feet for depths to 60 feet and every ten feet thereafter.

51

FLX-30BB OPERATION

Power Modes

The “P” on the MODE Control stands for Power. The unit will start in the factory default setting, so the main dial will show you an H-P designation, for High Power. Adjust the Mode Control to the “P” setting, then push-in on the Gain Control once. The display will now show “M-P”, for Medium power for two seconds. Push in on the Gain Control again to switch to the “L-P”, or Low Power Mode, and again to cycle back through to “H-P”.

Depth Range Ranges

The default range group is the Shallow, or “S” ranges, which are 10,15, 20, 30 and 40 feet. To go deeper with Manual Ranges, set the Mode Control to the “R” setting and then push in on the Gain Control once to select the Middle, or “M” for depth ranges. Now you have ranges of 50, 75, 100, 125 and 150 feet. Tap it again to go deeper. The Deep or “D” depth ranges are 175, 200, 225, 250 and 300 feet. Tap once more to go back to the default Shallow ranges.

Interference Rejection

Interference Rejection (IR) is a feature that allows you to fish around other sonar systems without seeing a lot of random signal flashes or slow-moving signals rotating on your display. IR, as it is called, is an automatic feature on the FLX-30 if the unit is in the water when the system is turned on. The sonar system listens for other sonar signals and selects a clean setting for you.

To activate the manual option of adjusting your IR settings, press in and hold the Gain Control for two seconds while in any mode setting OTHER than “C”. The display will show you your current IR setting and then you have five seconds between each press of the Gain Control to sample another IR setting level from 1 to 20. After five seconds, the FLX-30 will resume normal operation.

There are 20 IR settings for each frequency. This gives you 140 total Interference Rejection settings.

Color Select

The FLX-30 includes 5 optional color palettes to choose from. Set the Mode Control to the C position, then press in on the Gain Control to cycle through the available palettes. See page 56 for an explanation of each, but the default setting is #3 (white, red, yellow, green)

Night Mode

Night Mode is an option that dims the display lights so that when you are fishing at night, it’s not so bright on your eyes. Day Mode is best for using outside or during the day, using super bright LEDs at full brightness. To access this feature, set the Mode Control to the C setting and press and hold in the Gain Control for about two seconds. The display will dim.

Now the brightness of the lights will be cut by nearly 50%. Reverse the process to return to standard brightness or simply turn you unit off and then on again. Night Mode is a great feature to have since the sunlight readable display on the FLX-30 will actually start to cause discomfort if you look at a display at full brightness for a long period of time in a dark environment. The ability to dim the lights makes it comfortable to watch for hours with no eye stress.

Battery Voltage vs Percentage of Charge Remaining

Battery Voltage	Percent Charge
13.0 or more	100%
12.9	80%
12.8	60%
12.7	40%
12.6	20%
12.5	0% LOW BAT Steady
12.4	0% LOW BAT Flashing

These values are based on the Vexilar Lithium battery.

LP Mode & Open Water Use

The Digital Depth display will not work in Medium or Low Power modes. This is because a sufficiently strong enough digital depth readings cannot be maintained when running in these mode.

Because the Auto Range technology was designed specifically for an ice fishing environment, it is recommended to use Manual Range settings for open water use. If you lose the digital bottom depth reading in a known area, or it does not seem to match with what the flasher display is reading, these factors may come into play:

1. Very Soft Bottom
2. Too many fish (Depth readings will jump up and back to bottom as fish pass)
3. Too Much Vegetation
4. Your actual depth may be deeper than the current range selected (Shift to a deeper range)

NOTE: When fishing in very shallow water, you will see that the FLX-30 will not register a digital depth readout when you are in waters shallower than 3 feet.



FLX-30BB OPERATION

Advanced FLX-30BB Applications

Why does anyone need seven frequencies? Why would anyone ever change the power setting or need to adjust the color palette? These questions and many more come to mind when you start thinking about why you would ever need to adjust or change any setting if you simply use the “AUTO” Mode setting to get the job done?

Sitting at home, the question is a logical one, but as you spend more and more time on the water, you will ask the system to do more and more for you. While the FLX-30 was designed to be the ultimate in interference rejection technology offering 140 possible scenarios, there is a side benefit to having seven frequencies to choose from. So in time you will master and be able to customize your FLX-30 for your specific lake or style of fishing.

Fishing in Weeds

Fish love weeds, and can be caught in and around them with great consistency. Sonar does not know what it is bouncing a signal off of, so all that raw data comes into the receiver and is displayed as a very confusing amount of lines and colors on the dial. First off, realize the wider the cone angle the more weeds you will see. A 160 kHz frequency transmits at about 15 degrees and the 300 about 8 degrees. This allows you to first off, select the cone angle that

54

will reduce the total amount of weeds you will see. In this case, wider is not better! Next you want to dial back the intensity of the display so the strongest signals remain. A live fish will obviously be more sonar sound reflective than a soft weed stem, so backing down the power to Medium or even Low Power so you can actually see fish in weeds!

Fishing Suspended Fish

Many anglers love to fish 15-18 feet down over 50 feet of water for suspended panfish or trout. In the Auto range setting you have your entire display dedicated to the 50-foot depth you are fishing. With the use of the manual ranges you can ignore the bottom 30 feet of unproductive water and by switching to manual depth range of 0-20 feet. Now you will greatly improve the size and clarity of the school and your lure below you.

Fishing in a School

Adjusting your gain levels and working through the frequency settings, you will find one that, “pulls apart the school” it will break the “blob” of a tight grouping for fish sitting at 25 feet to a half dozen key targets that are different in color from the rest of the school. If you have seen a Vexilar working in the past, you understand the concept of green flashes are the weak signals. This

also applies to the FLX-30, but now the strongest color is white not red. By adjusting your frequencies, and power levels you can begin to fish only the fish that are directly below you in white! Sure, some fish might be seen at 20 feet with green lines, while at 24 feet you have a strong white signal. With these settings you can drop your lure past the green fish signals and specifically target THAT white fish target. This function is very productive.

The Ultimate Color Display

Do the colors on the display make a difference while fishing? For sure they do, and it is good to get familiar with them. The classic three-color Red, Yellow Green display is ONLY the beginning. With five color palettes to choose from, we can customize the display that is most enjoyable for you. Like option #5 for all those color blind people out there.

The more colors you display at one time the more accurate data flows to your display. All this might seem great, but in some cases too much data is TOO confusing. So, color option #2 is offered to knock-out the weaker signals or as some call it “clutter” and only show you Yellow and Red signals. Ideal in weeds or at night when bugs are hatching and your display lights up with green lights so badly you cannot see your own lure, so in this mode the green



FLX-30BB OPERATION

strength signals are removed leaving only the stronger yellow and red signals for targeting fish and your lure, NOT tiny bugs. To gain the true benefits of this multi-color display, you will need to adjust power and frequency settings.

You Decide the Level of Performance You Need

You can see by these various scenarios, you have control of your depth ranges for the highest resolution, you have control of power levels to sharpen your signals and allow you to see or NOT see what you need in signals. Then frequency to adjust beam size and kill any interference. Knowing how to adjust these three variables to fit your personal needs is just that A personal thing. In the world of sonar, the concept of specifics goes right out the window in the real world. In one application the wider 160 kHz frequency might deliver a sharper and cleaner signal than 275 kHz. Gain levels might need to be adjusted just slightly to make your lure just the right size so you can even see your minnow on the hook! So, in the end, trial and error is a good thing, finding the settings that work for your style of fishing is all that really counts in the end, and the FLX-30 gives you those options!

55

FLX-28 AND FLX-30^{BB} COLOR PALETTES

Color Modes allow you to tailor the display to both control the presentation of the information displayed, as well as fit your viewing comfort.

Refer to this manual for the steps required to enter into Color Select Mode for your model. FLX-28: Page 40 FLX-30^{BB}: Page 52



Color Mode 1: Classic Vexilar - Red, Yellow, Green

In this application, green shows you the weakest signals below you. Commonly weeds are shown in green and even your lure sometimes would be shown as green. If you turn up the gain setting, that same green signal will change to yellow or maybe even red. Yellow is the next strongest signal and then red, which will be on your display at the zero mark and again to show you bottom. The beauty of the Vexilar three-color system is that you are able to adjust your gain so that a fish target at the outer edges of the signal will be green and as it approaches your lure will shift to yellow and then red when the fish is directly below your hole.

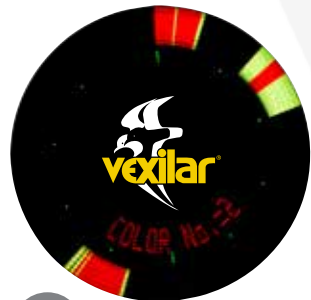

Color Mode 2: Red and Yellow Only

The more you use a Vexilar, the more you are confronted with situations where you will often be seeing a lot of green in your display. Heavy weeds, for example, or in some lakes where tiny bugs are so thick on a lake at night they trigger a green cloud on your display. By taking out the green, you take out much of the confusing signals that you normally have to fish around. In this setting, your lure will be yellow and you will notice that fish will “suddenly appear” more, since the weaker green signal is no longer there to alert you of a fish on the outer edge of your coverage.

56



Color Mode 3: White, Red, Yellow, Green (Factory Default)

While color setting #2 limits some of the signals you could display, color option #3 goes to the opposite end of the spectrum. With green once again being the weakest signal, the yellow stronger and the red now becomes not the strongest signal but the SECOND to the strongest. White becomes the strongest color now. The advantage of the four colors will be to allow you to target specific fish that are directly below you, if you are fishing a school of fish for example. It is often called a “Christmas Tree” because of the wide variety of colored lights you will see when you find yourself fishing over a large group of fish. When you see a fish in red, then turn to white, you know the fish is inches from your lure. The four color setting will allow you to see more individual targets, which might be too confusing to some, but you will gain the ability to target specific fish better.



Color Mode 4: White, Red, Yellow, Green, Blue

In all other modes, filtering limits the total signal level you see on the display. The micro-processor then decides when a target is worthy of your attention or not. The five color option turns all filtering off to show you nearly every signal possible. The dynamic range of each color allows YOU not the computer to interpret the colorful signal display. On one hand, you might think having all this information is a good thing, but if you can see the curl of our own fishing line as a blue signal in the display, are you happy or just confused? To skilled flasher anglers, having five colors gives you more advance warning of nearby fish, better understanding of fish attitudes and even know if your bait is on the hook or not. Give it a try and see if you like it.



Color Mode 5: White, Red, Blue

Designed to function EXACTLY like color option #1, but some people are color blind and have difficulty distinguishing the red/yellow/green color palette. Setting #5 is an alternative that has proven to be much easier to see for these people. Blue replaces green as the weakest color, then red and now white will be the most intense sonar signal strength. You do not need to be color blind to use this color option if you like it.

57

THE GENZ PACK SYSTEM CASE

The Genz Pack offers a great value in an affordable ice fishing pack. It includes all of the basic components needed to ice fish with a Vexilar FL series flasher immediately. A key factor of the Genz Pack is that it fits on top of a five gallon bucket (not included).

Carry Case

The Genz "Blue Box" is a two-piece system made from a high density polyethylene.

GP0819
Shown

Mounting Base

The large mounting base offers ample room for the Vexilar flasher, or other brands of sonar and GPS.



Battery and Charger
12 Volt - 9 Amp SLA Battery with Charger



Accessories

Use the pre-drilled holes for Vexilar add-on accessories, such as the FlexLight and DD-100. See pages 70 & 71.



Carry Case Base

The base is designed to fit perfectly on top of a five-gallon bucket.

Cable Storage
Place extra cable into the storage compartment under the flasher unit.

Eye-Bolt

Insert the transducer support eye-bolt here. Be sure to remove the float from the transducer cable when using the eye-bolt, which is commonly used on lakes with thin ice conditions.

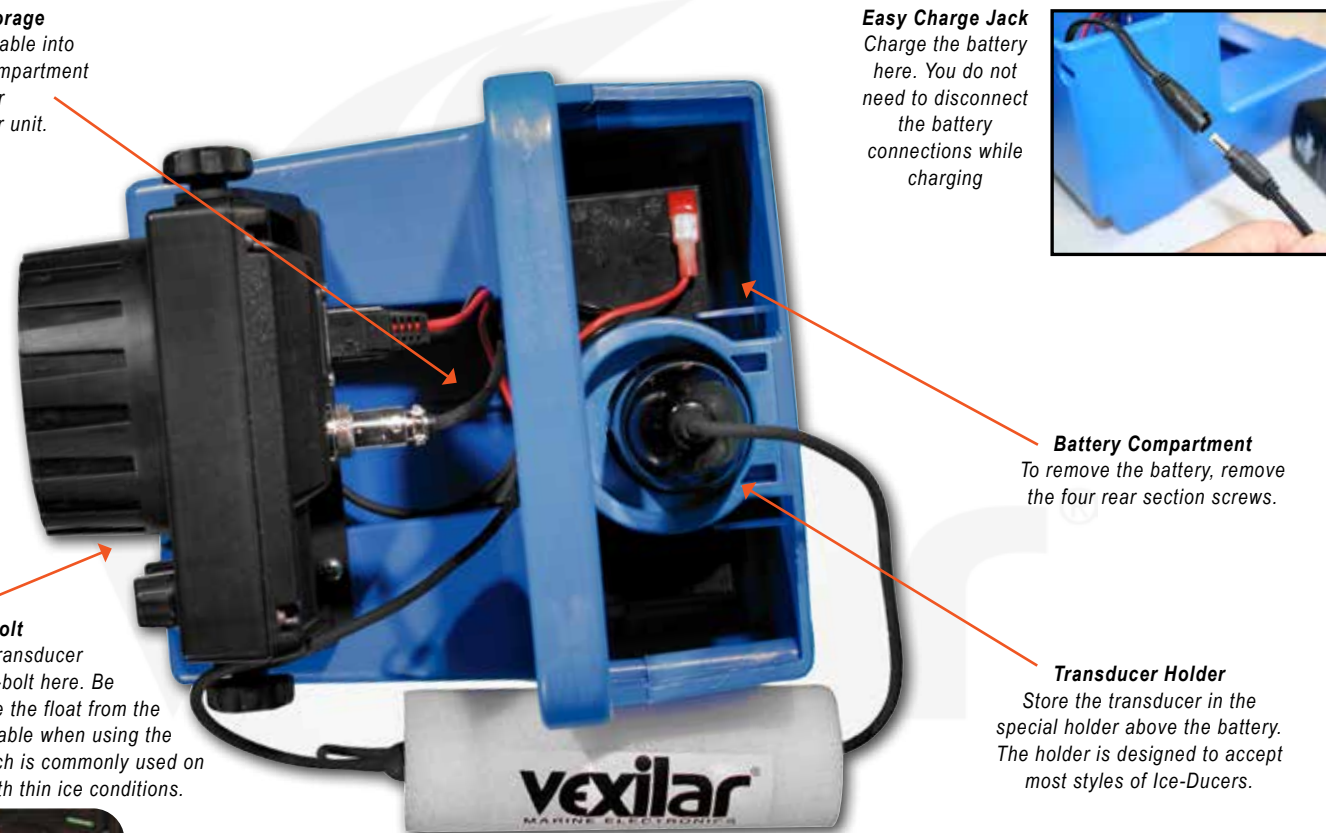

Easy Charge Jack
Charge the battery here. You do not need to disconnect the battery connections while charging



Battery Compartment

To remove the battery, remove the four rear section screws.

Transducer Holder

Store the transducer in the special holder above the battery. The holder is designed to accept most styles of Ice-Ducers.

THE PRO PACK II CASE

The Pro Pack II offers everything needed to begin ice fishing with a Vexilar color flasher, plus some extra add-ons to make the system more complete.

DD-100 Digital Depth / Battery Status
Shows the current depth in an easy-to-read number and the level of charge in the battery. See page 69 for instructions. (Not included with all packages)

Tackle Box
The Vexilar tackle box fits into a convenient location here.

Carrying Case Base
The round base is designed to fit inside a five-gallon bucket.

Eye-Bolt Storage
The transducer support eye-bolt fits into a dedicated storage location here

PPX2012D



Battery and Charger
12 Volt / 9 Amp SLA battery with 1 amp digital automatic charger.



IPX1212
Uses Pro Pack II case, but does not include the DD-100

Rod Holder
Adjustable angle and fits into either side of the case

Transducer Holder
Store the transducer in the special holder above the battery. The holder is designed to accept most styles of Ice-Ducers.

Cable Storage & Cleats
Use the cable handle as your cable storage and the tie-down cleats on either side to keep it in place and out of your way.

Eye-Bolt
Insert the transducer support eye-bolt here, the pack's front or far side. Be sure to remove the float from the transducer cable when using the eye-bolt.

Accessories
Use the pre-drilled holes for Vexilar add-on accessories, such as the FlexLight. See pages 70 & 71 for Accessories

Battery Compartment
To remove the battery, remove the flasher from the carrying case, then the transducer holder by removing the two mounting screws.

Easy Charge Jack
Charge the battery here. Connect the Easy Charge Jack to begin the charging process. Be sure to disconnect from battery when putting the system away for more than a month, but remember to re-connect it before recharging once it comes out of storage or the battery will not receive a charge.



THE ULTRA PACK CASE

The Ultra Pack carry case is rugged and packed with features; tackle box, remote accessory posts, a strong float holding handle, four rod holder mounting locations, an enclosed battery compartment and master power switch.

FLX-28 & FLX-30 systems come standard with a 12 volt / 9 amp Vexilar Lithium battery & digital charger.



Enclosed Battery Compartment
The battery is enclosed within the base here.
Fits both Vexilar Lithium and standard SLA batteries.

Master Power Switch
Use this switch to turn all power on and off, including the power to the external posts. Remember that this switch must be ON to charge the battery.

FLX-28
Shown



Float Holder
Store the Ice-Ducer float here.

Eye-Bolt Storage
The transducer support eye-bolt fits into a dedicated storage location here

Rod Holder
Adjustable angle and fits into four mounting locations; either side, front and back.

External Power Posts
Optionally use these posts to power external accessories. (2 Amp Max Output)

62

Tackle Box
The Vexilar tackle box fits into an easy access holder on the back of your Ultra Pack.

Cable Storage and Cleats
Use the area behind the tackle box as your cable storage. Use the tie-down cleats on either side to keep it in place and out of your way.

Eye-Bolt
Insert the transducer support eye-bolt here, on the opposite side, or in the front. Be sure to remove the float from the transducer cable when using the eye-bolt.

Non-Slip Bottom
The non-slip bottom fits into a standard five-gallon bucket for convenient storage.

Accessories
Use the pre-drilled holes for Vexilar add-on accessories, such as the FlexLight. See pages 70 & 71.



Easy Charge Jack
Lets you charge the battery by plugging in your charger here.



Soft Pack
Soft Pack carrying case comes standard with all FLX-28 and FLX-30 Ultra Packs

Transducer Holder
Store the transducer in the special holder behind the battery compartment. The holder is designed to accept all styles of Ice-Ducers.

63

SLA BATTERY CHARGING

(Sealed Lead Acid)

Instructions for 1 Amp Digital Automatic Charger
(model V-410)



1. Allow the battery to warm up before charging. This makes it easier for the charger to charge the battery and the battery is more accepting of a charge.
2. Plug the charger into a wall outlet, verify that it is operating by noting the illuminated GREEN light.
3. Connect the charger to the Easy Charge Jack attached to the unit. The charger's light will switch to RED, indicating that it is connected correctly and the battery is charging.
4. Keep the charger plugged in and connected until the RED light has changed to GREEN. This indicates the battery is at full charge.
5. Unplug the charger from the wall outlet and disconnect from the battery.

Charging times will vary depending on how much the battery has been drained. If the battery has been completely drained (approx. 24 to 30 hrs. of use on a 9 amp battery) the battery will require about 9 hours of charging.

IMPORTANT: If you have an Ultra Pack system, be sure the Master Power switch is ON and the flasher is turned OFF for charging.

Once the battery is fully charged and the charger's light returns to GREEN, the charger is then operating in a "Maintenance Mode". At this stage, the charger can remain connected to an SLA battery indefinitely and the battery will be maintained at full charge.

There is no need to disconnect the flasher when charging, although it should be switched off. Also, make sure the battery has a full charge and is disconnected or that all power is switched off before putting it away for storage.

Remember to charge after each use!

Charger Troubleshooting

A **flashing red light** indicates that the battery is connected in reverse. Check to be sure the red wire is attached to the positive battery terminal and the black wire is connected to the negative.

If the **never turns red**, and all connections are good, this indicates that the battery is not accepting a charge. Leave the charger connected as voltage will be applied. Later, unplug the charger, wait one minute, then plug it back in. If the light does not change to red and accept a charge, the battery will need to be replaced.

SLA BATTERY MAINTENANCE

Keeping your Sealed Lead Acid battery in top condition is the key for your Vexilar's reliability. Follow these basic tips and you can expect years of dependability from your Vexilar equipment:

SLA Battery Do's

- Allow SLA battery to FULLY recharge at room temperature before use. Recharge the battery AFTER EACH USE.
- Give cold batteries extra time to charge. Charge at room temperature if you can.
- Keep Flames, Sparks, and Metal objects away from batteries and terminals.
- If the battery is an open type, add distilled water AFTER battery is recharged.
- Keep the battery clean and dry.
- Charge periodically during battery storage.
- Disconnect the battery, or turn the Master Power Switch OFF when not in use.

SLA Battery Don'ts

- Do Not Over-discharge the battery. You should never drain a battery beyond 80%, meaning less than 20% left. Make sure any other devices are disconnected from the battery before storage.
 - Do Not Overcharge the battery. Measure the voltage of

the battery while charging. It should never go over 15 volts. Your Vexilar charger is designed to provide an optimal charge to your battery. Please only use Vexilar chargers.

- Do Not damage the battery or terminals by dropping. Your battery is heavy, but fragile. Take care that it doesn't get banged around or dropped.

Common Problems

- **Battery gets hot:** A battery that gets hot while charging has become "resistive". Current passes through it, but the battery will not charge. The battery must be replaced.
- **Battery recharges for a short time, even when full:** This means the battery is not accepting a charge. The capacity of the battery has been diminished. The battery should be replaced.
- **Battery will not charge:** If you connect a room temperature battery and the charger will not start, the battery may be over-discharged. When this happens, the charger does not even recognize it has been connected to terminals. Leave the charger connected to see if it will come back. If it will not accept a charge within 24 hours the battery should be replaced.

VEXILAR LITHIUM CHARGING

Instructions for 1 Amp Digital Automatic Charger
(model V-410)



- 1 Allow the battery to warm up before charging. This makes it easier for the charger to charge the battery and the battery is more accepting of a charge.
- 2 Plug the charger into a wall outlet, verify that it is operating by noting the illuminated GREEN light.
- 3 Connect the charger to the Easy Charge Jack attached to the unit. The charger's light will switch to RED, indicating that it is connected correctly and the battery is charging.
- 4 Keep the charger plugged in and connected until the RED light has changed to GREEN. This indicates the battery is at full charge.
- 5 Unplug the charger from the wall outlet and disconnect from the battery.

IMPORTANT: Out of the box, your Vexilar Lithium battery is only 50% charged. **You must charge it fully before first use.**

CARE AND MAINTENANCE

The power supply options for fishing are changing rapidly, now anglers have the option of using the traditional SLA (Sealed Lead Acid) batteries for their Vexilar systems or the next generation of battery, Vexilar Lithium. As with all batteries, how it is maintained is the key to years of reliable use. Understand not all Lithium is the same. Vexilar Lithium has been specifically designed to work with the V-410 charger. Also, please do not attempt to use a Vexilar V-410 Charger on other brands of Lithium and assume the charger will properly charge the battery.

Vexilar Lithium Do's

- Recharge battery after every use, even if the battery status indicators say they are at 100%. **DISCONNECT THE CHARGER AS SOON AS THE CHARGE IS COMPLETE**
- Charge the battery only when it is warm.
- Unlike the optional V-410L, the standard V-410 charger is NOT a rapid charger, expect to charge your battery over-night after each fishing trip. 12 hours of charging may be required after a long weekend of fishing.
- It is OK to store the battery over the summer at 30-50% of capacity, but for longer periods of storage, charge every few months.

Vexilar Lithium Don'ts

- Do not allow the charger to remain connected to the battery after the charge is complete (Green Light)
- Never interrupt the charging cycle once it has begun, this will confuse the charger into thinking the battery is already charged and stop charging.
- Sudden drops are bad news! There is a specialized circuit inside every battery call the BMS, if this circuit is damaged, the battery will simply go dead to protect itself. This is not repairable, so the battery needs to be replaced.
- Vexilar Lithium batteries should never be punctured or exposed to 150 degrees or more.
- Never submerge batteries. They are water-resistant, but if submerged, they will fail and cannot be repaired. This type of accident is not covered under warranty.
- Do not use any brand of charger other than VEXILAR to charge this battery.
- Vexilar Lithium batteries were designed to be charged with our Vexilar V-410 and V-410L charger, DO NOT attempt to charge other brands of Lithium batteries with Vexilar chargers.
- It is best to NOT store the battery when it is fully discharged for a long period of time.



BATTERY WARRANTIES

Pro-Rated SLA Battery Warranty

The battery warranty is covered under a pro-rated performance guarantee. Failure to properly care for battery is not the responsibility of Vexilar. Here are the details of the battery coverage from Date of Purchase (Proof of purchase will be required):

- Less than 30 days from purchase date – Full replacement
- Less than six months and greater than 30 days – \$12.00
- Greater than six months and less than one year – \$20.00
- Over one year and less than two years – \$25.00
- Over two years – No warranty – New purchase price.

Vexilar Lithium Warranty

Vexilar Lithium batteries have a full replacement warranty, two years from date of purchase. The battery must not have been submerged, damaged or improperly charged.

All costs do not include shipping



DD-100 DIGITAL DEPTH INDICATOR

The DD-100 is Vexilar's first smart digital indicator display that offers both digital depth and a battery indicator when you push the "push to test button." The DD-100 will work on all Vexilar FL/FLX series of flashers, including older Hondex, Si-tex and Micronar FL-8® models. Vexilar's new DD-100 gives anglers what they have been asking for, "Digital Depth!"

The digital depth display will always give you a depth reading as long as your Vexilar FL flasher is turned on and the transducer is in the water. The digital depth portion of the indicator will work even if you're not in the correct depth range. This will allow you to get your flasher in the best depth range possible. If your display is blinking or the depth numbers are going up or down rapidly, it could be that you're over a huge school of fish or baitfish OR the bottom is irregular.

The DD-100 was designed to fit in place of the popular D-130 or T-130 battery indicators which Vexilar has been selling for years. You can easily outfit your Pro Pack, Ultra Pack or Genz Pack with the DD-100. The DD-100 not only gives you digital depth, but also gives you the battery status of an SLA battery by pressing a button.

The only time you will see a battery status is when you push the "push to test button." The SLA battery status is given in percentages of voltage remaining in the battery. For example, if you push the "push to test button," and it reads 70%, that means your SLA type battery is at 12.2 volts, 100% = 12.7 volts and 0%=11.0 volts.

Current draw: 124uA (micro amps) when off and 21mA (milliamperes) when on.

Note: This is not a charge indicator. It will give only current status of an SLA battery's voltage. (Not compatible with Vexilar Lithium batteries)

Note: Flasher must be in Normal Power Mode (not LP Mode or while using an S-Cable) to get a reliable bottoms signal.



FLASHER ACCESSORIES



Ultra Pack Carry Case - UC-100

This portable case has all the features. Upgrade your older system or build a custom new system. Includes D-130 SLA Battery Status Indicator.



Pro Pack II Carry Case - PC-100

The latest generation of our most popular portable carrying case.



Genz "Blue Box" Carry Case - BC-100

A solid carrying case for your Vexilar flasher or other electronics.



S-Cable - S-140

The suppression cable reduces your flasher's output power. This allows clearer readings in shallow or cluttered waters.



Mag Shield - MS0001

Mag Shield both magnifies and protects the FL-8®SE or FL-18 displays.

(Not compatible with other models)



Ultra/Pro Soft Pack - SP0007

Soft Pack for Pro & Ultra Carry Cases encloses and protects the system. Offers a clear zippered window and access locations.



Genz Pack Soft Pack - SP0005

Soft Pack for Genz Pack protects the system. Offers Velcro seal-able access locations and side pocket storage.



Flasher Cover - COV001

Neoprene cover will protect the flasher face during transport and storage. Not for FL-8SE or FL-18



SupportArm-TSA001

Use this support arm in place of the Ice-Ducer float. Helps prevent fish tangling around the cable.

FlexLight

with UV light mode for glowing lures plus a blinking white safety light. Runs on a single AA battery (not included)



L-202



Pro-View Ice-Ducer - TB0051

The ultimate in beam precision and flexibility. Compatible with all FL/FLX series flashers. (works on FLX-30 at 200kHz only)



Pro Mount - SMC001

Offers a swivel action and quick removal for your flasher or other electronics. It's durable and economical.



A.C.E. Adhesive - ACE001

This acoustically conductive epoxy system is designed for maximum performance with minimal in-hull transducer installation effort.



Beverage Holder - CH-100

Fits into the rod holder on the Ultra Pack and Pro Pack II and allows you to keep your favorite beverage close at hand.



GLO-RING - VGR-001

Works like a Vexilar carry case rod holder, but inside the ring are 18 super bright, UV LEDs to charge a lure instantly with 360-degree coverage. Blast your lure with UV light by simply dropping the lure into the lighted chamber for a few seconds.



Digital Depth & Battery Level - DD-100

Shows the current depth and level of charge as a percentage left in the battery. For SLA batteries only.



Battery Status Indicator D-130

Shows percentage of battery remaining, plus re-charging status. SLA batteries only.



Tackle Tote - TT-100

A handy soft sided tackle box that holds three of our 4 by 6 inch Vexilar tackle boxes. Use it for all seasons.



Accessory Plug PCDC A1 / PCDC A4

Power your FL/FLX unit via an automotive or ATV power jack. (Not for Charging)

TRANSDUCERS OPTIONS

Transom Mount High Speed Styles (25' Cable)

- TB0030 - 9° Cone Angle
- TB0044 - 19° Cone Angle
- TB0084 - 12° Cone Angle
- TB0045 - Dual 9/19° Cone Angle

Transom style transducers include the mounting bracket and have 25 feet of cable length. Conversion kits include the transducer, flasher mounting bracket, power cable, and installation hardware.

Transom Style Conversion Kits

- TK-144 - 19° for the FL-8@SE and FL-18
- TK-244 - 19° for the FL-12, FL-20, FL-22 & FLX Series
- TK-184 - 12° for the FL-8@SE and FL-18
- TK-284 - 12° for the FL-12, FL-20, FL-22 & FLX Series
- TK-130 - 9° for the FL-8@SE and FL-18
- TK-230 - 9° for the FL-12, FL-20, FL-22 & FLX Series
- TK-145 - Dual 9/19° for the FL-8@SE and FL-18
- TK-245 - Dual 9/19° for the FL-12, FL-20, FL-22 & FLX Series
- BK0044 - Suction Cup Mount for all of the above High Speed Transducers.

Puck Styles (25' Cable)

- TB0023 - 19° Cone Angle
- TB0087 - 12° Cone Angle
- TB0027 - 9° Cone Angle
- TB0032 - Dual 9/19° Cone Angle

Puck style transducers include a trolling motor mounting tie and A.C.E. adhesive for in-hull mounting. All have 25 feet of cable length. Conversion kits include the transducer, flasher mounting bracket, power cable, and installation hardware.

72 *Dual beam transducers include a beam switch assembly.*

Puck Style Conversion Kits (25' Cable)

- TK-123 - 19° for the FL-8@SE and FL-18
- TK-223 - 19° for the FL-12, FL-20, FL-22, & FLX Series
- TK-187 - 12° for the FL-8@SE and FL-18
- TK-287 - 12° for the FL-12, FL-20, FL-22 & FLX Series
- TK-127 - 9° for the FL-8@SE and FL-18
- TK-227 - 9° for the FL-12, FL-20, FL-22 & FLX Series
- TK-132 - Dual 9/19° for the FL-8@SE and FL-18
- TK-232 - Dual 9/19° for the FL-12, FL-20, FL-22 & FLX Series
- BK0023 - Suction Cup Mount for the TB0023 19° Puck Transducer
- BK0027 - Suction Cup Mount for the Pro View and DB Transducer

Universal Transducer Kit (30' Cable)

- TK-100 - 19° Transducer Kit for all FL/FLX series flashers.

Includes options for transom, trolling motor and suction cup mounting

Ice-Ducers (7' Cable)

- TB0050 - 19° Cone Angle
- TB0080 - 12° Cone Angle
- TB0051 - Pro View 9° (30°)
- TBB-100 - Broad Band for FLX-30

Transducer Exchange Policy

If you find that you have bought the wrong transducer for your intended fishing application, you can exchange your new transducer with Vexilar. You will only need to pay the retail cost difference of the transducer style, plus shipping. Please call for more information.

Transducer Switches and Extensions

- CB0001 - 10 foot transducer cable extension
- CB0002 - 20 foot transducer cable extension
- SB-100 - Switch box for switching between two transducers on one flasher
- SB-200 - Switch box for two flashers on one transducer.

Replacement Parts

- PC0001 - 6' Power cord for the FL-8@SE and FL-18
- PC0004 - 6' Power cord for the FL-12, FL-20, FL-22 & FLX Series
- PC0001C - 14" Power cord w/Quick-Charge plug for FL-8@SE and FL-18
- PC0004C - 14" Power cord w/Quick-Charge plug for FL-12, FL-20, FL-22 & FLX Series
- GB0001 - Unit gimbal mounting bracket for FL/FLX Series Flashers
- GBK001 - Gimbal mounting bracket knobs (2 pieces)
- FT-100 - Float with stopper for all Ice-Ducers
- ST-100 - Stopper for all Ice-Ducers (2 pieces)
- RB-100 - Eye-bolt support for all Ice-Ducers
- RH-100 - Rod Holder assembly for Ultra Packs and Pro Pack IIs
- CH-100 - Beverage Holder for Rod Holder.
- TKB100 - Vexilar 4 by 6 inch tackle box
- V-120 - 12 Volt / 9 Amp Hour SLA Battery and 1 Amp Automatic Charger
- V-410 - 12 Volt / 1 Amp Vexilar Charger
- V-410L Rapid Charge Vexilar Lithium Charger
- V-100 - Replacement 12 Volt / 9 Amp Hour SLA Battery Only
- PCDCA1 - 12 Volt Accessory Plug Power Cord (FL-8@/FL-18)
- PCDCA4 - 12 Volt Accessory Plug Power Cord (FL-12, FL-20, FL-22 & FLX Series)

- V-100L - 12 Volt Vexilar Lithium Battery Only
- V-120L - 12 Volt Vexilar Lithium Battery & Charger
- DD-100 - Digital Depth Display & Charge Status*
- D-130 - Digital Battery Status*
- FH1000 - Fuse Holder

* For SLA batteries only

To order, go to
Vexilar.com
or call
952-884-5291



Storage & Prevention Tips

- Store in cool dry area. Do not store in a sealed container, like a bucket or Soft Pack, trapping moisture.
- Be sure an SLA battery is fully charged before storage.
- Clean the flasher body and screen with a soft cloth and a mild detergent. Do not submerge in water or other liquids.
- Do not expose the body or display to chemicals, such as fish attractant or insect repellent. Damage to the surfaces can occur.
- Do not submerge the body in water or subject it to heavy wave splashing. The flasher housing is weather-proof for most conditions, but is not waterproof. Water damage is not covered under the warranty.

General Trouble Shooting

Symptom	Possible Cause
Unit is turned on, but no display and motor is not running.	Check for bad connections, proper hook up polarity, and make sure you have a good, fully charged battery.
Unit is turned on and the motor is running, but there is no display.	Battery voltage too low. The unit will show no display if the voltage is below 8 volts. Check voltage while unit is running.
Unit runs well for a short time, then lights flash randomly or unit quits.	Bad battery or connection. Voltage may be good when checked, but will fall as unit runs.
Unit runs and shows display light, but does not read depth.	Transducer is not plugged in or not in contact with the water.
Unit works, but needs high gain to see bottom or targets.	Transducer is not aimed correctly or needs to be cleaned. 19° transducers will have trouble seeing small targets deep.
Unit works, but has too many lines on the display. Can't tell what is what.	Improper transducer adjustment. Also, gain may be set too high or, if gain is set to minimum, switch to the LP Mode.
Unit works well when sitting still or at when slow trolling, but loses reading at higher speeds.	Improper transducer type, install, or adjustment causing loss of clear water flow across the transducer when the boat reaches a certain speed.
Unit shows noise when engine or electric motor is turned on.	Defective engine or electric motor. Also can be improper grounding or missing ground in electrical system.
I.R. does not work. Can't eliminate interference from other depth finder.	Gain may be set too high or the transducer is weak. Also, check for ice or debris buildup under the Gain Control.



Electrical Interference Trouble Shooting

There may be situations where you experience interference from other electrical devices, not just another nearby depth sounder. This interference will show on your display as random signals and interfere with your ability to see the normal display signals. The most common sources of interference are electric trolling motors and engine ignitions systems. Your flasher's IR feature won't help much, as this is designed for cross-talk, but here are some tips that might.

Sources

Interference can be introduced into your sonar system through the power supply, transducer line, or both. To identify the source, unplug the transducer and run the trolling motor or the engine. If the interference disappears, you know the noise is coming in through the transducer line. If not, it's coming through the power line, or both.

Wiring

Power line interference can generally be solved by improvements in the wiring positions, connections, and grounding. You want to be sure the sonar wiring is as far away as possible from the trolling motor wiring, and the wiring is neat. Make cable runs as short as possible and neatly coil extra wire and tie it off so it stays put in rough water or while pulling the boat. All electrical connections should be in very good condition. Push-on terminals should be tight. Wire crimp connections should not come free when pulled firmly. Conductors should be shiny, not dull or corroded.

Grounding

The boat's electrical system should have a common "Earth" ground to the water. Most boats electrical systems are grounded through the outboard to the water. Many times a electric trolling motor interference problem can be solved by a "ground" wire from the negative trolling motor power source to the negative of the starting battery.

Equipment

Electric trolling motors and gas engines can have technical problems that can cause interference. If common wiring improvements do not solve the problem, be sure to check with the manufacturer to see if there are any recommendations or updates available regarding interference with depth sounders.

VEXILAR SUPPORT

If you find that you need help please contact us. Have ready the model number and, if possible, the serial number of your product. Please be sure to read this manual thoroughly and check vexilar.com for answers first.

Address

Vexilar, Inc.
6667 West Old Shakopee Road, Suite 101
Minneapolis, MN, 55438-2622

Telephone: (952) 884-5291

Fax: (952) 884-5292

Email: service@vexilar.com

Web Site: <https://vexilar.com>

Business Hours: 8:00 AM to 4:30 PM M - F Central Time

Don't Forget: Register Your Vexilar Product Online!

In addition to streamlining any future service need, we'll also keep you up-to-date on the latest tips, videos and product updates so you'll be sure to get the most from your Vexilar!

Go to <http://vexilar.com/warranty>

76



Disclaimer:

This USER MANUAL is intended for use with units produced in 2020 and beyond. Over time, features and functions of units change and this user manual may become obsolete for some models but not for others. Vexilar is always striving to improve the features, performance, components and reliability of the products they produce. The FL-8 of 40 years ago is not the same FL-8 of today. Vexilar strives to keep user functions consistent from one generation to the next.

Vexilar's SONARPHONE is a REVOLUTION

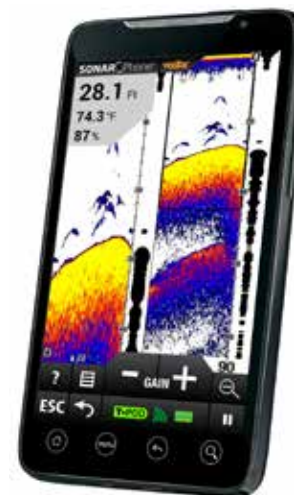

The new SONARPHONE gives you amazing high-speed depth sounder performance on your Phone or Tablet

No cell service is required!

As the name implies, SONARPHONE turns your smart phone or tablet into a fully functional sonar system that will rival any high end sonar on the market today. Using Patented WiFi signal technology to transmit to smart phones or tablets. You don't need cell phone coverage to use it, the SONARPHONE will work anywhere in the world. The SONARPHONE creates its own WiFi hotspot and you can share your signal with as many people as you wish, the SonarPhone App is downloaded for free from the App store and works with both Android and iOS systems.

- Compatibility: iOS 4.3 (iPhone, iPad) and Android
- Free App download
- Automatic Ranging & Gain
- Water Temperature & Depth Indicator
- Audible Alarms for Fish, Shallow and Low Battery
- Fish Icon
- Zoom Bottom Track
- Noise Rejection
- Surface Clarity
- Battery Indicator
- Models Available:
 - SP100 (T-Pod) and SP200 (T-Box)

Visit SonarPhone.mobi for More Info!

U.S Patents: 9,628,592 B2 - 9,989,639 - 9,408,378

Chinese Patent # 102866402 | Australian Patent # 2013305395 | Pending European Patent # 13830402.7

Fish Scout Underwater Camera System

The Vexilar FS800IR Fish Scout Underwater Camera System consists of a color/black and white camera, a 7" color LCD monitor, a rigid carrying case with an enclosed 12 volt - 9 amp hour SLA battery, a 1 Amp Digital charger and a protective soft pack carrying case. This camera offers superior cold weather performance with automatic monitor warming technology.

Monitor

- 7" 16:9 widescreen "a-SI TFT" active matrix display
- Monitor resolution: 800 x 480 (W x H)
- Video Out option

Camera

- 1/3" CMOS color/B&W sensor (switches automatically)
- Infrared Lighting
- 90 degree viewing angle
- 600 lines if resolution
- 90 feet of cable



Visit Vexilar.com to see the complete Vexilar product line!

77

Vexilar Two-Year Extended Limited Warranty Application

Price: \$39.95 USD (Anytime within 12 months of purchase)

Model Units Covered

FL-8@SE • FLX-12 • FL-18 • FLX-20 • FLX-28 • FLX-30

If you purchased a new Vexilar pack that includes a qualifying model, you may buy the extended warranty, for that head unit only, from Vexilar, Inc. for up to 12 months after your purchase. This warranty is transferable to a new owner.

Order On-Line _____
Save the stamp and the mailing hassles. Just go online to complete your standard warranty registration and complete the extended warranty form on our website.

<http://vexilar.com/warranty>



Notice: The model and serial number of your unit **MUST** be provided to Vexilar with your original purchase date to be able to register your unit for your first two year warranty **AND** to be able to purchase the additional two year extended warranty. Batteries are excluded. (see page 68)



Extended Limited Warranty

The Vexilar extended Warranty is not only the best in the Marine Industry, but also an exceptional value. Your new Vexilar has a full two-year limited warranty against defects or malfunctions in material, workmanship, or against failure to conform to the product's written specifications. (See specifics in this Vexilar owner's manual.)

Now you have the opportunity to extend the warranty protection of your Vexilar unit from the time of purchase by an additional **two years**—for a total of **FOUR YEARS** of protection. Models FL-8@SE, FLX-12, FL-18, FLX-20, FLX-28 & FLX-30 are eligible for this program. This Two-year Extended Warranty must be purchased within twelve (12) months from the original date of purchase for \$39.95. (Please note, your two years of extended Limited Warranty coverage will take effect after the original factory warranty expires. This will give you a total of four years of limited coverage based on the original purchase date of the unit.)

How To Apply

If you decide to participate in the extended warranty program anytime within twelve (12) months after the original purchase date of the unit, you must buy it directly from Vexilar, Inc. for \$39.95. To qualify, follow the instructions on the previous page. When mailing your registration, please fill out the information on the extended warranty application completely. The serial number of the unit is located on the back of the head assembly. Vexilar will send you a notice via mail confirming your extended warranty is valid and activated within 6 to 8 weeks. The reply from Vexilar will clearly state when your extended warranty period expires. If you do not get a confirmation notice within this time, please contact Vexilar customer service immediately as no extended warranty service on your unit will

be done if you did not apply properly.

Be sure to keep copies of all receipts for your own records. For more information or for additional copies of the Vexilar Limited Extended Warranty forms call: 952-884-5291, e-mail warranty@vexilar.com or visit our website. See order form for complete listing of the select models covered. Vexilar, Inc. may find it necessary to change or modify this offer at any time.

Extended Warranty Coverage

The Extended Warranty gives you two extra years on the “head” assembly for model FL-8@SE, FLX-12, FL-18, FLX-20, FLX-28 and FLX-30 units. During the extended warranty period, Vexilar, Inc. will repair or at its option, replace any parts, labor and return shipping at no cost to you. Your unit's serial number must be on file with Vexilar in order to receive warranty coverage. The unit must be shipped prepaid to...

Vexilar, Inc. Attn: Customer Service
6667 West Old Shakopee Road, Suite 101
Minneapolis, MN 55438

This warranty does not apply if the product has been damaged by accident, misuse, internal water damage or as a result of service modification by anyone other than the factory. This extended warranty does not cover batteries, chargers, cases, accessories, transducers, gimbal bracket or lost parts. This warranty is transferable to new owners.

Please print clearly.

VEXILAR TWO-YEAR EXTENDED LIMITED WARRANTY APPLICATION FORM

# PAYING BY CREDIT CARD	<input type="checkbox"/> Visa <input type="checkbox"/> MasterCard	CREDIT CARD (CHECK ONE)	CARD NUMBER	EXPIRATION DATE	CVV
NAME	ADDRESS	CITY	STATE	ZIP	E-MAIL
MODEL	SERIAL NUMBER	PLACE OF PURCHASE	DATE OF PURCHASE	SIGNATURE	TODAY'S DATE
(Required)					



Warranty Information

This VEXILAR product is warranted against factory defects in material and workmanship for a period of 2 years from the date of purchase or receipt as a gift*. SLA batteries offer a pro-rated warranty, see page 68 for more information. During the warranty period, VEXILAR will repair or at its option, replace at no cost to you for labor, materials or return transportation provided the unit is returned, shipped prepaid to Vexilar, Inc., 6667 West Old Shakopee Road, Suite 101, Minneapolis, MN 55438-2622. This warranty does not apply if the product has been damaged by accident or misuse, or as a result of service or modification by other than the factory. If a replacement is given, the original warranty period shall resume upon date of receipt.

Except as otherwise expressly stated in this previous paragraph, the COMPANY MAKES NO REPRESENTATION OR WARRANTY OF ANY KIND, EXPRESSED OR IMPLIED, AS TO MERCHANTABILITY, FITNESS FOR A PARTICULAR PURPOSE, OR ANY OTHER MATTER WITH RESPECT TO THIS PRODUCT. Company shall not be liable for, and purchaser assumes responsibility for, all personal injury and property damage resulting from the handling, possession or use of the product by Purchaser or others who obtain it through purchaser.

* A sales receipt with date of purchase may be requested before service work is done under warranty if no warranty registration information is on file. A serial number or UPC code on the box cannot be used to establish date of purchase.

Save the Stamp

Visit the Vexilar website and register your new Vexilar product quickly and easily free, plus opt in to receive helpful usage tips from the pro staff and the latest in Vexilar news and events delivered right to your email.

Register Your Warranty Online

<https://vexilar.com/warranty>

The Vexilar Website Also Offers

Full Product Information | Tips and Articles
Instructional Video | Hard-to-Find Accessories
Free Downloads