

Smart choice for power™

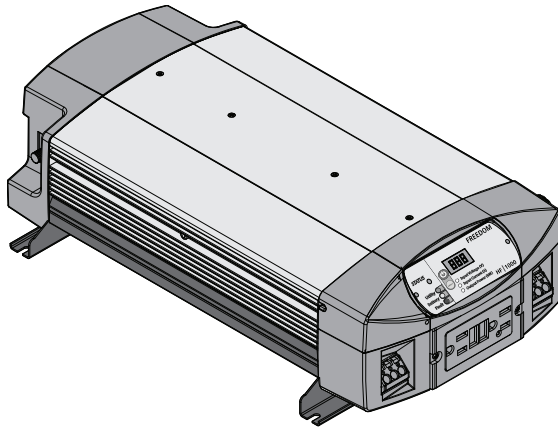

Product image shown may vary from actual product. See features for comparisons.

xantrex™

Installation Guide

Freedom HF Inverter/Chargers

Model Product Numbers

806-1020
806-1054, 806-1054-01
806-1055, 806-1055-02
806-1544
806-1840, 806-1840-01,
806-1840-02

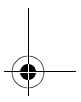
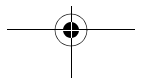
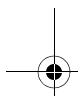
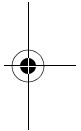
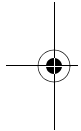
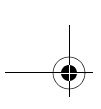

Copyright © 2014 Schneider Electric. All Rights Reserved. All trademarks are owned by Schneider Electric Industries SAS or its affiliated companies.

Exclusion for Documentation

UNLESS SPECIFICALLY AGREED TO IN WRITING, SELLER

- (A) MAKES NO WARRANTY AS TO THE ACCURACY, SUFFICIENCY OR SUITABILITY OF ANY TECHNICAL OR OTHER INFORMATION PROVIDED IN ITS MANUALS OR OTHER DOCUMENTATION;
- (B) ASSUMES NO RESPONSIBILITY OR LIABILITY FOR LOSSES, DAMAGES, COSTS OR EXPENSES, WHETHER SPECIAL, DIRECT, INDIRECT, CONSEQUENTIAL OR INCIDENTAL, WHICH MIGHT ARISE OUT OF THE USE OF SUCH INFORMATION. THE USE OF ANY SUCH INFORMATION WILL BE ENTIRELY AT THE USER'S RISK; AND
- (C) REMINDS YOU THAT IF THIS MANUAL IS IN ANY LANGUAGE OTHER THAN ENGLISH, ALTHOUGH STEPS HAVE BEEN TAKEN TO MAINTAIN THE ACCURACY OF THE TRANSLATION, THE ACCURACY CANNOT BE GUARANTEED. APPROVED CONTENT IS CONTAINED WITH THE ENGLISH LANGUAGE VERSION WHICH IS POSTED AT WWW.XANTREX.COM.

Document Part Number

975-0395-01-01

Date and Revision

April 2014 Rev D

Product Numbers

1000-watt Models:

- 806-1020 (Freedom HF 1000)
- 806-1055, 806-1054, 806-1054-01 (Freedom HF 1055)
- 806-1055-02 (Freedom HF 1055 EMS)

1500-watt Model:

- 806-1544 (Freedom HF 1500)

1800-watt Models:

- 806-1840 (Freedom HF 1800)
- 806-1840-01 (Freedom HF 1800 T)
- 806-1840-02 (Freedom HF 1800 EMS)

Contact Information

Telephone: +1 800 670 0707
+1 408 987 6030

Web: www.xantrex.com

Information About Your System

As soon as you open your product, record the following information and be sure to keep your proof of purchase.

Serial Number _____

Product Number _____

Purchased From _____

Purchase Date _____

To view, download, or print the latest revision, visit the website shown under Contact Information.

About This Guide

Purpose

The purpose of this Installation Guide is to provide explanations and procedures for installing and configuring a Freedom HF Inverter/Charger for Recreational, Fleet Vehicle, or Marine installations.

Scope

The Guide provides safety guidelines, as well as information about operating and troubleshooting the installation. It does not provide details about particular brands of batteries. You need to consult individual battery manufacturers for this information.

Audience

The information in this Guide is intended for qualified personnel. Qualified personnel have training, knowledge, and experience in:

- Installing electrical equipment and PV power systems (up to 1000 volts).
- Applying all applicable installation codes.
- Analyzing and reducing the hazards involved in performing electrical work.
- Selecting and using Personal Protective Equipment (PPE).

Conventions Used

The following conventions are used in this guide.

DANGER

DANGER indicates an imminently hazardous situation, which, if not avoided, will result in death or serious injury.

WARNING

WARNING indicates a potentially hazardous situation, which, if not avoided, can result in death or serious injury.

CAUTION

CAUTION indicates a potentially hazardous situation, which, if not avoided, can result in moderate or minor injury.

NOTICE

NOTICE indicates a potentially hazardous situation, which, if not avoided, can result in equipment damage.

IMPORTANT: These notes describe things which are important for you to know, however, they are not as serious as a caution or warning.

Related Information

You can find more information about Xantrex products and services at www.xantrex.com.

Important Safety Instructions

IMPORTANT: READ AND SAVE THIS INSTALLATION GUIDE FOR FUTURE REFERENCE.

This chapter contains important safety instructions for the Freedom HF Inverter/Charger (Freedom HF). Each time, before using the Freedom HF, READ ALL instructions and cautionary markings on or provided with the inverter/charger, the batteries, and all appropriate sections of this guide.

NOTE: The Freedom HF contains no user-serviceable parts.

DANGER

ELECTRICAL SHOCK HAZARD

- Do not expose the Freedom HF to rain, snow, spray, or bilge water. This inverter/charger is designed for marine applications only when additional drip protection is installed in certain orientations. See the installation guide for information.
- Do not operate the inverter/charger if it has received a sharp blow, been dropped, has cracks or openings in the enclosure including if the fuse cover has been lost, damaged, or will not close, or otherwise damaged in any other way.
- Do not disassemble the inverter/charger. Internal capacitors remain charged after all power is disconnected.
- Disconnect both AC and DC power from the inverter/charger before attempting any maintenance or cleaning or working on any circuits connected to the inverter/charger. See note below.
- Do not operate the inverter/charger with damaged or substandard wiring. Make sure that all wiring is in good condition and is not undersized.

Failure to follow these instructions will result in death or serious injury.

NOTE: Turning off the inverter/charger using the on/off switch on the front panel will not reduce an electrical shock hazard.

 **DANGER**

FIRE AND BURN HAZARD

- Do not cover or obstruct the air intake vent openings and/or install in a zero-clearance compartment.
- Do not use transformerless battery chargers in conjunction with the inverter/charger due to overheating.

Failure to follow these instructions will result in death or serious injury.

 **DANGER**

EXPLOSION HAZARD

- Charge only properly rated (such as 12 volts) lead-acid (GEL, AGM, Flooded, or lead-calcium) rechargeable batteries because other battery types may explode.
- Do not work in the vicinity of lead-acid batteries. Batteries generate explosive gases during normal operation. See note #1.
- Do not install and/or operate in compartments containing flammable materials or in locations that require ignition-protected equipment. See notes #2 and #3.

Failure to follow these instructions will result in death or serious injury.

NOTES:

1. Follow these instructions and those published by the battery manufacturer and the manufacturer of any equipment you intend to use in the vicinity of the battery. Review cautionary markings on these products and on the engine.
2. This inverter/charger contains components which tend to produce arcs or sparks.
3. Locations include any space containing gasoline-powered machinery, fuel tanks, as well as joints, fittings, or other connections between components of the fuel system.

Precautions When Working With Batteries

WARNING

BURN FROM HIGH SHORT-CIRCUIT CURRENT, FIRE AND EXPLOSION FROM VENTED GASES HAZARDS

- Always wear proper, non-absorbent gloves, complete eye protection, and clothing protection. Avoid touching your eyes and wiping your forehead while working near batteries. See note #4.
- Remove all personal metal items, like rings, bracelets, and watches when working with batteries. See notes #5 and #6 below.
- Never smoke or allow a spark or flame near the engine or batteries.
- Never charge a frozen battery.

Failure to follow these instructions can result in death or serious injury.

NOTES:

1. Mount and place the Freedom HF Inverter/Charger unit away from batteries in a well ventilated compartment.
2. Always have someone within range of your voice or close enough to come to your aid when you work near a lead-acid battery.
3. Always have plenty of fresh water and soap nearby in case battery acid contacts skin, clothing, or eyes.
4. If battery acid contacts skin or clothing, wash immediately with soap and water. If acid enters your eye, immediately flood it with running cold water for at least twenty minutes and get medical attention immediately.
5. Use extra caution to reduce the risk of dropping a metal tool on the battery. It could spark or short circuit the battery or other electrical parts and could cause an explosion.
6. Batteries can produce a short circuit current high enough to weld a ring or metal bracelet or the like to the battery terminal, causing a severe burn.
7. When removing a battery, always remove the negative terminal from the battery first for systems with grounded negative. If it is grounded positive, remove the positive terminal first. Make sure all loads connected to the battery and all accessories are off so you don't cause an arc.

Precautions When Preparing to Charge

WARNING

EXPOSURE TO CHEMICALS AND GASES HAZARD

- Make sure the area around the battery is well ventilated.
- Make sure the voltage of the batteries matches the output voltage of the inverter/charger.
- Be careful to keep corrosion from coming into contact with your eyes and skin when cleaning battery terminals.

Failure to follow these instructions can result in death or serious injury.

NOTES:

- Study and follow all of the battery manufacturer's specific precautions, such as removing or not removing cell caps while charging, whether equalization is acceptable for your battery, and recommended rates of charge.
- For flooded non-sealed batteries, add distilled water in each cell until battery acid reaches the level specified by the battery manufacturer. This helps to purge excessive gas from cells. Do not overfill. For a battery without removable cell caps, carefully follow manufacturer's instructions.

Precautions When Placing the Inverter/Charger

WARNING

FIRE HAZARD

Do not install the inverter/charger or any part of its supplied wiring in engine compartments.

Failure to follow these instructions can result in death or serious injury.

NOTICE

RISK OF DAMAGE TO THE INVERTER/CHARGER

- Never allow battery acid to drip on the inverter/charger when reading gravity, or filling battery.
- Never place the Freedom HF Inverter/Charger unit directly above batteries; gases from a battery will corrode and damage the inverter/charger.
- Do not place a battery on top of the inverter/charger.

Failure to follow these instructions can damage the unit and/or damage other equipment.

Precautions for Using Rechargeable Appliances

NOTICE

RISK OF DAMAGE TO RECHARGEABLE APPLIANCES

Avoid using the following with the Freedom HF:

- Small battery-operated appliances like flashlights, razors, and night lights that can be plugged directly into an AC receptacle to recharge.
- Some chargers for battery packs used in power hand tools. These affected chargers display a warning label stating that dangerous voltages are present at the battery terminals.

Failure to follow these instructions can damage the unit and/or damage other equipment.

Most rechargeable battery-operated equipment uses a separate charger or transformer that is plugged into an AC receptacle and produces a low voltage charging output.

Some chargers for small rechargeable batteries can be damaged if connected to the Freedom HF.

If you are unsure about using your rechargeable appliance with the Freedom HF, contact the equipment manufacturer to find out if the appliance is acceptable for use with an inverter that has a **modified sine wave output** voltage.

Regulatory

The Freedom HF Inverter/Charger is certified to appropriate US and Canadian standards. For more information see .

The Freedom HF Inverter/Charger is intended to be used for mobile or commercial applications. This inverter/charger is designed for marine applications only when additional drip protection is installed in certain orientations. See the installation guide for information.

It is not intended for other applications as it may not comply with the additional safety code requirements needed for those other applications. See “Limitations On Use” below.

⚠ WARNING

LIMITATIONS ON USE

Do not use in connection with life support systems.

Failure to follow these instructions can result in death or serious injury.

NOTE: The Freedom HF Inverter/Charger is a modified sine wave inverter/charger. Please ensure your equipment or devices are compatible with modified sine wave prior to usage.

FCC Information to the User

This equipment has been tested and found to comply with the limits for a Class B digital device, pursuant to part 15 of the FCC Rules. These limits are designed to provide reasonable protection against harmful interference in a residential installation. This equipment generates, uses, and can radiate radio frequency energy and, if not installed and used in accordance with the instructions, may cause harmful interference to radio communications.

However, there is no guarantee that interference will not occur in a particular installation. If this equipment does cause harmful interference to radio or television reception, which can be determined by turning the equipment off and on, the user is encouraged to try to correct the interference by one or more of the following measures:

- Reorient or relocate the receiving antenna.
- Increase the separation between the equipment and receiver.
- Connect the equipment into an outlet on a circuit different from that to which the receiver is connected.
- Consult the dealer or an experienced radio/TV technician for help.

CAUTION

Unauthorized changes or modifications to the equipment could void the user's authority to operate the equipment.

KKK Information to the User

The Freedom HF 1055 EMS and 1800 EMS models are marked “KKK-A-1822D Ready”. These models are marketed for use in ambulances and emergency vehicle applications. For information of compliance of the ambulance as a whole, please refer to specifications as laid out in Federal Specification for the Star-of-Life Ambulance also known as KKK-A-1822.

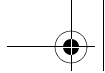

Contents

Important Safety Instructions	iii
Materials List	1
Safety Instructions	2
Installation Tools and Materials	3
High Level Overview of Installation Steps	4
Basic Installation Procedures	5
Drip Shield Installation (For Marine Installations)	34
Configuration	36
Marine Installation	37
Specifications	38

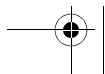
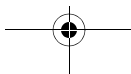
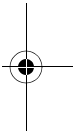
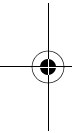

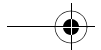

Materials List

The Freedom HF (PNs: 806-1840, 806-1020) base package includes the minimum following items:

- one Freedom HF unit
- one set of owner's and installation guides and a mounting template
- one display panel with 7-inch (0.17 m) cable
- one communications cable (25 feet) (7.5 m)
- two DC terminal covers
- one strain-relief clamp
- one GFCI cover plate with knockout
- one display panel blanking plate (not shown)
- one display panel mounting bezel (not shown)
- one set of lock washers and nuts (not shown)

NOTE: If any of the items are missing, contact Xantrex or any authorized Xantrex dealer for replacement. See "Contact Information" on page i.

Other Freedom HF OEM models may include other DC and/or AC connectors.

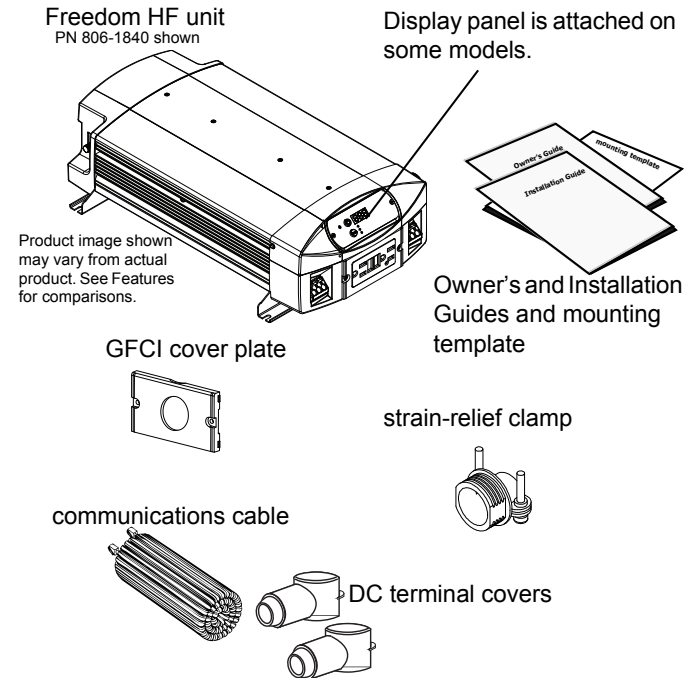

This guide for use by qualified personnel only.

Figure 1 What's In The Box

Safety Instructions

Before You Begin the Installation

Before beginning your installation:

- Read the entire Installation Guide so you can plan the installation from beginning to end.
- Assemble all the tools and materials you require for the installation.
- Review the Important Safety Instructions on page iii.
- Be aware of all safety and electrical codes which must be met.

DANGER

ELECTRICAL SHOCK AND FIRE HAZARD

- All wiring should be done by qualified personnel to ensure compliance with all applicable installation codes and regulations.
- Disconnect all AC and DC power sources.
- Disable and secure all AC and DC disconnect devices and automatic generator starting devices.

Failure to follow these instructions can result in death or serious injury.

Installation Codes

Governing installation codes vary depending on the specific location and application of the installation. Some examples include the following:

- The U.S. National Electrical Code (NEC)
- The Canadian Electrical Code (CEC)
- The U.S. Code of Federal Regulations (CFRs)
- Canadian Standards Association (CSA) and the RV Industry Association (RVIA) for installations in RVs
- The American Boating & Yachting Committee (ABYC) for Marine installations in the U.S.

It is the installer's responsibility to ensure that all applicable installation requirements are met.

Installation Tools and Materials

You will need the following to install the Freedom HF:

- Wire stripper
- Mounting screws or bolts
- #2 Phillips screwdriver
- 3.5mm slot long neck screwdriver for WAGO¹ terminals that are available in Freedom HF 1000, 1055, and 1800 models.
- Wrench for DC terminals (1/2" or 13mm or adjustable)
- AC cable (i.e. two-conductor-plus-ground cable), sized appropriately for load and application
- Wire nuts or crimp connectors for AC wire and appropriate tools
- Two 1/2" strain-relief clamps (supplied) for AC cables
- DC cable, sized appropriately for load and application
- Lugs for DC cables to fit 8 mm (5/16") DC stud terminals) as well as appropriate tools (e.g. crimping tool)
- AC and DC disconnects and over-current protective devices

1. WAGO® manufactures connection devices such as terminal blocks and related accessories. Many Freedom HF models use WAGO terminal blocks as AC input and output connections.

High Level Overview of Installation Steps

Installing the Freedom HF includes the following steps.

1. Ensure that AC and DC power are both OFF.
2. Mount the inverter securely and permanently in one of the acceptable orientations.
3. Connect the Equipment Grounding Terminal to the equipment ground bus.
4. Connect the AC input wiring to the AC source panel.
5. Connect the AC output wiring to the AC load panel.
6. Connect one end of the DC negative cable to the negative of the battery, and the other to the negative terminal of the unit.
7. Install an appropriately sized fuse and DC disconnect in the positive cable.
8. Connect the DC positive cable to the positive of the battery, and to the positive terminal of the unit.
9. Close the DC disconnect switch.

Do not proceed with installation until you have read “Safety Instructions” on page 2.

Basic Installation Procedures

This section provides sample installation information as a guide for your installation. For your convenience, the overall procedure is divided into ten main steps:

- Step 1:** Designing an installation. (Start on page 6.)
- Step 2:** Choosing a location for the Freedom HF. (Start on page 12.)
- Step 3:** Mounting the Freedom HF. (Start on page 13.)
- Step 4:** Connecting the AC input wires. (Start on page 15.)
- Step 5:** Connecting the AC output wires. (Start on page 19.)
- Step 6:** Connecting the DC cables. (Start on page 22.)
- Step 7:** Mounting the display panel. (Start on page 31.)
- Step 8:** Testing your installation. (Start on page 32.)

This guide for use by qualified personnel only.

Basic Installation Procedures

Step 1: Designing the Installation

Most Freedom HF installations share common components, and some of these are briefly described below. Figure 2 shows some components and their relationship to each other in a typical recreational vehicle or fleet vehicle installation. (Also, see “Marine Installation” on page 37.)

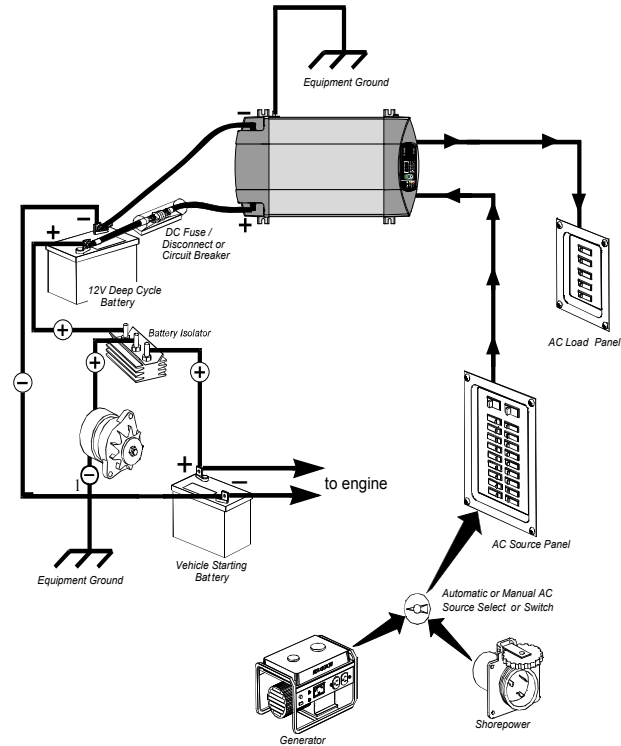

Figure 2 Typical Recreational Vehicle and Fleet Vehicle Installation

AC Shore Power

A source of 120 volts, 60Hz sine wave alternating current is needed to provide energy to charge batteries and pass power through to AC loads. This source is usually the utility grid (power company) or an AC generator. An automatic or manual AC source selector switch can be used to switch between the multiple sources of shore power to the Freedom HF system.

The AC source feeding the Freedom HF must have the neutral conductor bonded to ground. When the inverter passes shore power through, it will lift the bonding relay on the output and will rely on the input being bonded in order to ensure that the power delivered to a sub panel is properly bonded. See “AC Output Neutral Bonding” on page 9 for more information on bonding relay operation.

IMPORTANT: Throughout this manual, the term “shore power” refers to AC input power from a utility grid, generator, or other AC source.

AC Input: The circuit breaker or fuse (connected through hard wiring) that is used to supply the Freedom HF must be rated at no more than 30A and must be approved for use on 120 volts AC branch circuits. The wire used between the breaker and the Freedom HF input must be sized adequately to carry current up to the rating of the input breaker and in accordance with the electrical codes or regulations applicable to your installation.

Generator

The Freedom HF is compatible with most generators which produce nominal 120 volts AC 60Hz sine wave AC power.

Since the DC charging current limit of the Freedom HF may be configured to provide as little as two amps it is possible to use very small generators with the Freedom HF to charge batteries. The Freedom HF has been tested with generators of various sizes, including some as small as 700 watts.

AC Disconnect and Over-Current Protection Device

Most safety requirements and electrical codes require the Freedom HF’s AC and DC inputs and outputs to be provided with over-current protection (such as circuit breakers or fuses) and disconnect devices.

AC Output: The circuit breaker or fuse must be rated at no more than the rating of the input breaker in the installation and must be approved for use on 120 volts AC branch circuits. The wire used between the Freedom HF and the AC output breaker must be of adequate size to match the AC input circuit breaker’s rating. The wiring from each AC output breaker to each of the loads must be adequately sized to carry the current rating of the individual AC output breaker.

This guide for use by qualified personnel only.

Basic Installation Procedures

Disconnect Devices: Each system requires a method of disconnecting the AC circuits. If the over-current protection devices are circuit breakers, they will also serve as the disconnects. If fuses are used, separate AC disconnect switches will be needed ahead of the fuses. These will have to be a branch circuit rated for 120 volts AC and have an appropriate current rating.

AC Distribution Panels

Most systems incorporate distribution centers both ahead of the Freedom HF (the AC source panel) and between the Freedom HF and the loads (the AC load panel). An AC source panel includes a main circuit breaker, which serves as over-current protection and as a disconnect for the AC shore power supply line. Additional circuit breakers serve individual circuits, one of which serves the Freedom HF. The AC load panel can incorporate an AC output circuit breaker and breakers for individual load circuits.

NOTICE

EQUIPMENT DAMAGE

Do not connect the output of the Freedom HF to what is known as a “multi-wire branch circuit”. These are four-wire circuits consisting of a ground, neutral, and two lines that are 180 degrees out of phase with each other (from a standard 120/240V “split phase” circuit). These circuits are commonly used in kitchens to power “split receptacles” where the top and bottom halves of a duplex receptacle are connected to different lines.

Failure to follow these instructions can damage the unit and/or damage other equipment.

AC Cabling

AC cabling includes all the wires and connectors between the AC source and the Freedom HF, as well as all cabling between the Freedom HF and the AC output panels, circuit breakers, and loads. The type and size of the wiring varies with the installation and load. For example, in high vibration environments, such as marine or RV applications, wire nuts may not be acceptable, so crimp splices would be required. In other applications, flexible multiple-strand wire may be required. Installation codes usually specify solid or stranded, overall size of the conductors, and type and temperature rating of the insulation around the wire.

AC breakers and fuses must be sized to adequately protect the wiring that is installed on the input and output AC circuits of the Freedom HF. All breakers and wiring must be sized and connected in accordance with the electrical codes or regulations applicable to your installation. Table 1 gives some examples of wiring sizes based on the U.S. National Electrical Code and the Canadian Electrical Code. These examples are based on using a two-conductor-plus-ground cable rated at 75 °C, and assuming an ambient temperature of up to 30 °C. Ensure that your breakers, and fuses have suitable temperature ratings for your wiring. Other codes and regulations may also be applicable to your installation.

Table 1 Required AC Wire Size vs Breaker Rating

Breaker Size (amps)	10A	15A	20A	30A
Minimum Wire Size	14AWG	14AWG	12AWG	10AWG

AC Output Neutral Bonding

The neutral conductor of the Freedom HF's AC output circuit (i.e., AC Output Neutral) is automatically connected to the safety ground during inverter operation. When AC utility power is present and the Freedom HF is charging, this connection is not present, so that the utility neutral (i.e., AC Input Neutral) is only connected to utility ground at your source. This conforms to National Electrical Code, which requires that separately derived AC sources (such as inverters and generators) to have their neutral conductors tied to ground in the same way that the neutral conductor from the utility is tied to ground in only one place. Check the regulations for your specific application to ensure that the installation will comply with the necessary requirements. In other words, the AC Input Neutral and Output Neutral must be isolated from each other.

This guide for use by qualified personnel only.

Basic Installation Procedures

AC Grounding

As per UL458 SA29.5, for all grounded AC cord-connected marine inverterchargers: The Freedom HF 1055 EMS and the Freedom HF 1800 EMS should be grounded to reduce risk of electric shock.

Make sure that the three-prong plug is plugged into properly installed and grounded AC wall outlet in accordance with all local codes and ordinances.

As per UL458 SA29.5, for all permanently connected marine inverterchargers: The rest of the Freedom HF models should be connected to a grounded, metal, permanent wiring system. Also, make sure that an AC ground wire is connected to the AC ground terminal on the unit. Do not just connect the line and neutral wires.

All connections to a unit should comply with all local codes and ordinances.

DC Cabling

This includes all the cables and connectors between the batteries, the DC disconnect and over-current protection device, and the Freedom HF. Most mobile installations require multi-strand insulated cables for flexibility and durability in high vibration environments and require disconnects and over-current devices. Electrical wiring sizes are indicated by AWG notation. Under the AWG standard, a larger gauge number indicates a smaller wire diameter. Wire size is usually marked on the larger sized cables. Table 2 specifies the minimum recommended DC cable size and

maximum fuse size for the Freedom HF. **The DC cables must be copper and must be rated 75 °C minimum.** The cables should be terminated with lugs that fit the DC stud terminals snugly (8 mm or 5/16" hole size).

Table 2 Recommended Cable and Fuse Sizes

Inverter/Charger	Cable Length: Battery to Inverter (one way)	Minimum Cable Size	Maximum battery Fuse Size
Freedom HF 1000/1055	Less than 5 feet (1.5 meters)	No. 2 AWG	150 Adc
Freedom HF 1500/1800	Less than 5 feet (1.5 meters)	No. 2/0 AWG	250 Adc

Note: It is not recommended using a cable longer than 5 feet (1.5 meters) in each direction. Cable sizes above are based on the US National Electrical Code Table 310.17 - 75C cables, assuming an ambient temperature of 30 °C cables.

IMPORTANT: Using the correct cable size is critical to achieving the rated performance of the Freedom HF unit. When starting a heavy load the Freedom HF can draw current surges from the battery of up to 400A. If the DC wiring is too small the voltage drop from this surge will result in a voltage at the Freedom HF terminals that is too low for the Freedom HF to operate correctly. The Freedom HF may appear to operate correctly with smaller cables until a heavy load such as a microwave or refrigerator attempts to start - then the unit may work correctly sometimes and not work correctly other times.

DC Disconnects and Over-Current Devices

The DC circuit from the battery to the Freedom HF must be equipped with a disconnect and over-current device. This usually consists of a circuit breaker, a “fused-disconnect,” or a separate fuse and DC disconnect. Do not confuse AC circuit breakers with DC circuit breakers. They are not interchangeable. The rating of the fuse or breaker must be matched to the size of cables used in accordance with the applicable installation codes. The breaker or disconnect and fuse should be located as close as possible to the battery, in the positive cable. Applicable codes may limit how far the protection can be from the battery.

Batteries

The Freedom HF uses 12-volt battery banks. Every Freedom HF system requires a deep-cycle battery or group of batteries that provide the DC current that the Freedom HF converts to AC.

Ground Fault Circuit Interrupters (GFCIs)

A GFCI is a device that de-energizes a circuit when a current to ground exceeds a specified value that is less than that required to blow the circuit breaker. GFCIs are intended to protect people from electric shocks and are usually required in wet or damp locations.

Installations in marine and recreational vehicles require GFCI protection of branch circuits connected to the AC output of the Freedom HF.

The modified sine wave output of the Freedom HF is not equivalent to the waveform provided by electric utilities, and compliance with UL and CSA standards requires that the manufacturer test and recommend specific GFCIs that will work correctly with the Freedom HF. Here are the recommendations:

Make	Model
Hubbell	GF15WLA
Leviton	N7599
Pass & Seymour	1595

This guide for use by qualified personnel only.

Basic Installation Procedures

Step 2: Choosing a Location for the Unit

WARNING

FIRE AND EXPLOSION HAZARDS

- Do not install the Freedom HF in compartments containing batteries or flammable materials, or in locations that require ignition-protected equipment. This includes any space containing gasoline-powered machinery, fuel tanks, or joints, fittings, or other connections between components of the fuel system. This equipment contains components that tend to produce arcs or sparks.
- Do not cover or obstruct the ventilation openings. Do not install the Freedom HF in a zero-clearance compartment. Overheating may result.

Failure to follow these instructions can result in death or serious injury.

The Freedom HF should only be installed in locations that meet the following requirements:

- Dry.** Do not allow water or other fluids to drip or splash on the Freedom HF. **Do not mount the Freedom HF in an area subject to splashing water or bilge water.**
- Cool.** Normal air temperature should be between 32 °F and 104 °F (0 °C and 40 °C)—the cooler the better.
- Ventilated.** Allow at least 5 inches (13cm) of clearance at the DC end of the Freedom HF for air flow, 1 inch (2.5cm) on each side, and 2 inches (5cm) at the AC end. The more clearance for ventilation around the unit, the better the performance. Do not allow the ventilation openings on the ends of the unit to become obstructed.
- Safe.** Do not install the Freedom HF in the same compartment as batteries or in any compartment capable of storing flammable liquids like gasoline.
- Close to the battery compartment and the AC source and load panels.** Avoid excessive cable lengths (which reduce input and output power due to wire resistance). Use the recommended cable lengths and sizes, especially between the battery banks and the Freedom HF.
- Protected from battery acid and gases.** Never allow battery acid to drip on the Freedom HF or its wiring when reading specific gravity or filling the battery. Also do not mount the unit where it will be exposed to gases produced by the batteries. These gases are very corrosive, and prolonged exposure will damage the Freedom HF.

Step 3: Mounting the Unit

To mount the Freedom HF:

1. Remove the Freedom HF from its shipping container, verify that all components are present, and record relevant product information on “Information About Your System” in the Owner’s Guide.
2. Select an appropriate mounting location and orientation. (See Figure 3 below.) To meet regulatory requirements, for use in on-land applications, the Freedom HF must be mounted in one of the following orientations:
 - Under a horizontal surface (see 1)
 - In a horizontal position on a vertical surface (see 2)

NOTE: For marine installations, only this orientation is allowed, due to the probability of moisture finding access into the enclosure.

- On a horizontal surface (see 3)

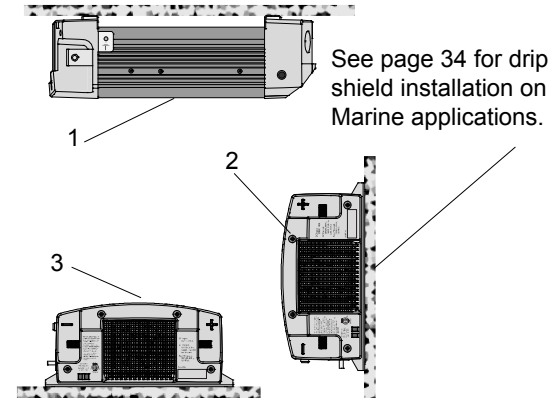

Figure 3 Approved Mounting Orientations

3. Look for the mounting template and unfold. Tape it to the mounting surface and pilot-drill the desired number of mounting holes. Remove the template.
4. Fasten the Freedom HF to the mounting surface. If you are mounting the unit on a wall or bulkhead, use #12 or #14 pan-head wood or sheet metal screws to secure it to the framing behind the wall or bulkhead. Alternatively, use nut inserts and 1/4”-20 machine screws.

This guide for use by qualified personnel only.

Basic Installation Procedures

Connecting the Equipment Ground

⚠ WARNING

FIRE HAZARD

Never operate the Freedom HF without properly connecting the equipment ground. A fire hazard could result from improper grounding.

Failure to follow these instructions can result in death or serious injury.

The Freedom HF has a ground stud on the side of the unit as shown in Figure 4. Follow the guidelines in “Grounding Locations” to connect the inverter’s chassis to the ground.

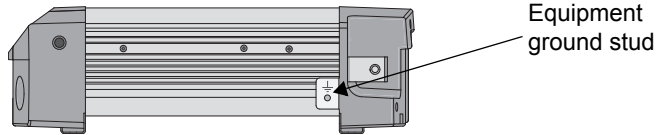

Figure 4 DC Panel Connections

Grounding Locations

You must connect the equipment ground stud to a grounding point—usually the vehicle’s chassis or DC negative bus ground—using recommended copper wire (if insulated then green insulation with or without one or more yellow stripes) or larger.

For recommended equipment ground cable size, see below.

Table 3 Recommended Equipment Ground Cable size

Application	Minimum equipment ground cable size (Stranded cable is recommended)
Recreational Vehicle ^a	No. 8 AWG
Marine ^b	No. 3 AWG (Freedom HF 1000) No. 1/0 AWG (Freedom HF 1500/1800)

NOTE: There are no restrictions on length for the equipment ground cable.

- a. Based on US National Electrical Code NFPA70, Article 551, par. 551-20c 2005 version.
- b. Based on ABYC E-11 11.18 dated 07/03

In general, the equipment ground cable size must not be smaller than one AWG size than the supply cable.

Step 4: Connecting the AC Input Wires

WARNING

FIRE, SHOCK, AND ENERGY HAZARDS

Make sure wiring is disconnected from all electrical sources before handling. All wiring must be done in accordance with local and national electrical wiring codes. Do not connect the output terminals of the Freedom HF to any incoming AC source.

Failure to follow these instructions can result in death or serious injury.

General AC Wiring Considerations

AC Wiring Connectors Where applicable, connect AC wires with crimp-on splice connectors. The amount of insulation you strip off individual wires will be specified by the connector manufacturer and is different for different types of connectors.

AC and DC Wiring Separation Do not mix AC and DC wiring in the same conduit or panel. Where DC and AC wires must cross, make sure they do so at 90° to one another. Consult applicable codes for details about DC and AC wiring in close proximity to each other.

AC Wiring and GFCIs You can plug loads (12 amps continuous, 15 amps maximum) directly into the GFCI receptacle on the front panel of the Freedom HF. You can also connect the inverter to an existing AC installation and then plug loads into GFCI receptacles connected to that circuit.

If you plan to use the Freedom HF with the GFCI installed on the unit, proceed to “Step 6: Connecting the DC Cables” on page 22.

AC wiring includes all the wires and connectors between the AC source and the Freedom HF and all wiring between the inverter, the AC panels, circuit breakers, and the GFCIs. The type and size of the wiring varies with the installation and load. For some RV applications, flexible multiple-strand wire is required.

AC wiring must be sized appropriately to carry full load current on the input and output AC circuits in accordance with the electrical codes or regulations applicable to your installation. Table 4 is based

This guide for use by qualified personnel only.

Basic Installation Procedures

on the U.S. National Electrical Code and the Canadian Electrical Code, assuming two-conductor-plus-ground cable, using 75 °C wiring, at an ambient temperature of 30 °C. Other codes and regulations may be applicable to your installation.

Table 4 Required AC wire size vs. required breaker rating

	Required Breaker Size (amps)	Required Wire Size
Freedom HF 1000	30 A maximum	10 AWG
Freedom HF 1055	30 A maximum	10 AWG
Freedom HF 1500	15 A maximum	custom cable with connector
Freedom HF 1800	30 A maximum	10 AWG
Freedom HF 1800 T	15 A maximum	custom cable with connector
Freedom HF 1800 EMS	15 A maximum	standard AC cable with three-prong grounded AC plug
Freedom HF 1055 EMS	15 A maximum	standard AC cable with three-prong grounded AC plug

The AC input terminal is located on the front panel and is labeled properly as **AC IN** or **AC INPUT**. Depending on the model, you can have three types of wire terminals.

- The Freedom HF 1000, Freedom HF 1055, Freedom HF 1800 and Freedom HF 1500 models come with WAGO-type terminals where individual wires can be attached securely.

- The Freedom HF 1800 T comes with a PTI¹ connector that attaches to an AC cable terminated with a corresponding PTI connector.
- The Freedom HF 1055 EMS and Freedom HF 1800 EMS come with a standard AC cable with three-prong grounded AC plug.

NOTICE

EQUIPMENT DAMAGE

Make sure the wires are connected properly. The AC wiring terminal blocks are split into input and output sections.

Failure to follow these instructions can damage the unit and/or damage other equipment.

When making the AC input and AC output connections, observe the correct color code for the appropriate AC wire, as described in Table 5.

Table 5 Color codes for typical AC wiring

Color	AC Wire
Black or Brown	Line
White or Blue	Neutral
Green, Green/Yellow, or bare copper	Ground

1. Phillips & Temro Industries manufactures accessories for heating, cooling, silencing, emission and hybrid/electric vehicle technologies. The electrical cables with PTI connectors referred to in this manual are custom cables that are available for the trucking industry.

NOTICE

REVERSE POLARITY DAMAGE

Make sure the wires are connected properly. Improper connections (connecting a line conductor to a neutral conductor, for example) will cause the Freedom HF to malfunction and may permanently damage the inverter. Damage caused by a reverse polarity connection is not covered by your warranty.

Failure to follow these instructions can damage the unit and/or damage other equipment.

AC Input Connections for the Freedom HF 1000, Freedom HF 1055, Freedom HF 1500, and Freedom HF 1800 Models

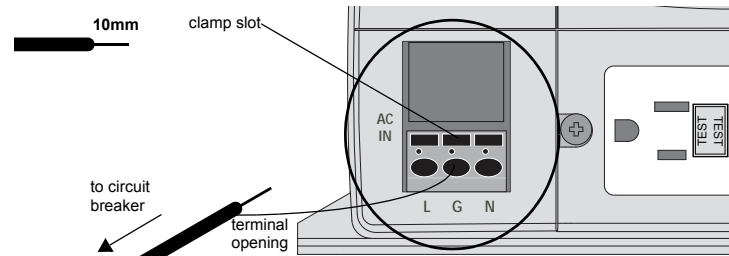

1. Ensure AC and DC power sources are turned off.
2. Install the required circuit breaker in the AC distribution panel supplying AC power to the unit.
3. Strip a single strand (e.g. Romex®)¹ AC input wire, as appropriate.
4. Locate the Line, Ground and Neutral terminals on the AC input terminal labeled as **L**, **G**, and **N** respectively.
5. Using a 3.5mm slot long neck screwdriver, open the WAGO cage clamp by inserting the tool in the clamp slot for Ground terminal.
6. Insert Ground AC wire into Ground terminal slot on the unit.
7. Repeat steps 5 and 6 for Line and Neutral connections.
8. Connect the other end of the wires to the circuit breaker in the AC distribution panel supplying AC power to the unit.

This guide for use by qualified personnel only.

¹ Romex is a brand name owned by Southwire and used here as an example but not as an endorsement of a particular brand.

Basic Installation Procedures

AC Input Connections for the Freedom HF 1800 T Model

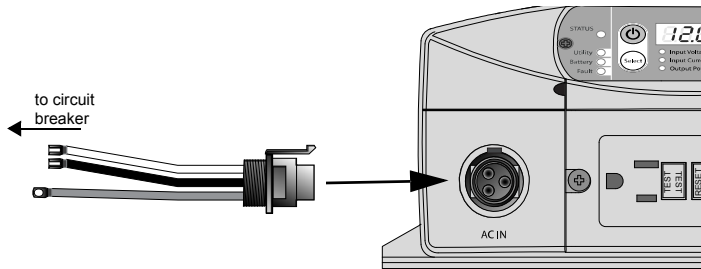

1. Ensure AC and DC power sources are turned off.
2. Install the required circuit breaker in the AC distribution panel supplying AC power to the unit.
3. Connect the female PTI cable connector to the AC IN male receptacle on the unit.
4. Connect the other end of the wires to the circuit breaker in the AC distribution panel supplying AC power to the unit.

AC Input Connections for the Freedom HF 1055 EMS and Freedom HF 1800 EMS Models

⚠ DANGER

ELECTRIC SHOCK HAZARD

Do not alter the AC cord and its three-prong plug. The AC cord is pre-installed and pre-wired to the AC Input terminals of the unit. Do not connect the plug to other than a properly grounded electrical wall outlet.

Failure to follow these instructions will result in death or serious injury.

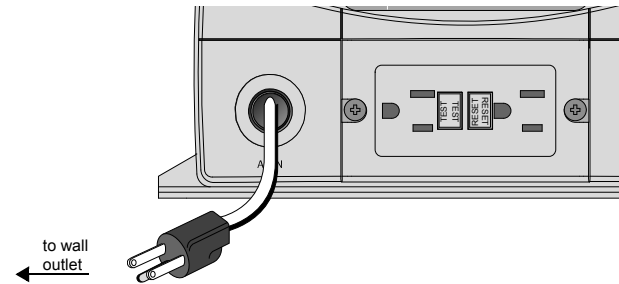

1. Ensure AC and DC power sources are turned off.
2. Connect the three-prong plug to an AC wall outlet.

Step 5: Connecting AC Output to an Existing AC Circuit

WARNING

FIRE, SHOCK, AND ENERGY HAZARDS

Make sure wiring is disconnected from all electrical sources before handling. All wiring must be done in accordance with local and national electrical wiring codes.

Failure to follow these instructions can result in death or serious injury.

NOTICE

EQUIPMENT DAMAGE

Do not connect any AC source (such as a generator or utility power) to the AC wiring output of the Freedom HF.
The Freedom HF will not operate if its output is connected to AC voltage from another source, and potentially hazardous or damaging conditions may occur. These conditions can occur even if the inverter is off.

Failure to follow these instructions can damage the unit and/or damage other equipment.

A manufacturer-tested and approved GFCI must be connected to the Freedom HF AC output, and on every receptacle connected to the AC hard wired installation. Other types may fail to operate properly when connected to the Freedom HF. Although you can reuse the factory-installed GFCI, the manufacturer has also tested and approved the following GFCIs for use with the Freedom HF inverter/charger. See “Ground Fault Circuit Interrupters (GFCIs)” on page 11.

WARNING

FIRE, SHOCK, AND ENERGY HAZARDS

Make sure wiring is disconnected from all electrical sources before handling. All wiring must be done in accordance with local and national electrical wiring codes.

Failure to follow these instructions can result in death or serious injury.

Do not connect the Freedom HF to an AC branch circuit that has high-power consumption loads.

The Freedom HF will not operate electric heaters, air conditioners, stoves, and other electrical appliances that consume more than 1000 watts (Freedom HF 1000) or 1800 watts (Freedom HF 1800).

Basic Installation Procedures

AC Output Connections for the Freedom HF 1000, Freedom HF 1055, and Freedom HF 1800 models

To make a permanent connection to existing AC wiring:

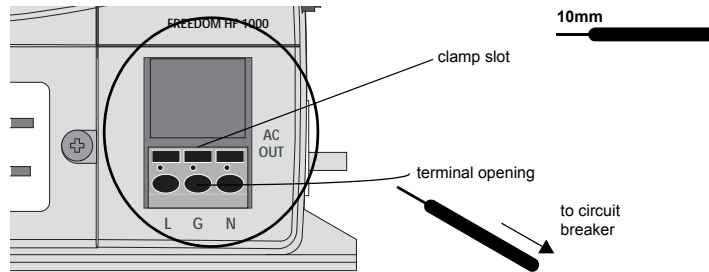

1. Ensure AC and DC power sources are turned off.
2. Install the required circuit breaker in the inverter distribution panel receiving AC power from the inverter.
3. Strip a single strand (e.g. Romex) AC output wire, as appropriate.
4. Locate the Line, Ground and Neutral terminals on the AC OUT terminal labeled as **L**, **G**, and **N** respectively.
5. Using a 3.5mm slot long neck screwdriver, open the WAGO cage clamp by inserting the tool in the clamp slot for Ground terminal.
6. Insert Ground AC wire into Ground terminal slot on the unit.
7. Repeat steps 5 and 6 for Line and Neutral connections.
8. Connect the other end of the wires to a circuit breaker in the inverter distribution panel.

AC Output Connections for the Freedom HF 1800 T Model

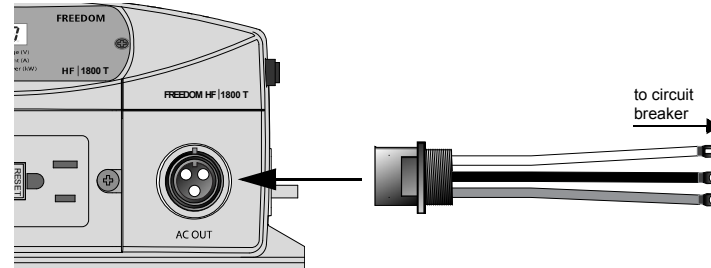

1. Ensure AC and DC power sources are turned off.
2. Install the required circuit breaker in the inverter distribution panel receiving AC power from the inverter.
3. Connect the male PTI cable connector to the AC OUT female PTI receptacle on the unit.
4. Connect the other end of the wires to a circuit breaker in the inverter distribution panel.

AC Output Connections for the Freedom HF 1055 EMS and Freedom HF 1800 EMS Models

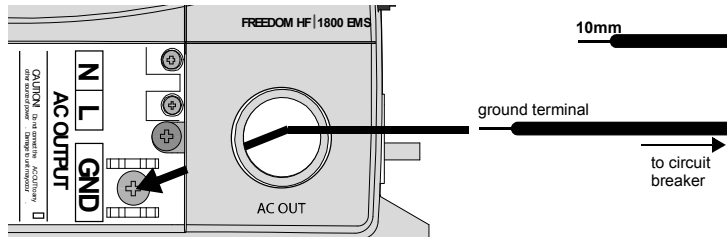

1. Ensure AC and DC power sources are turned off.
2. Install the required circuit breaker in the inverter distribution panel receiving AC power from the inverter.
3. Remove the GFCI unit to expose the AC output terminals inside the wiring compartment behind the AC OUT knockout.
4. Install a strain-relief clamp on the AC OUT knockout.
5. Strip a single strand (e.g. Romex) AC output wire, as appropriate.
6. Locate the Line, Ground and Neutral terminals on the AC output terminal labeled as **L**, **GND**, and **N** respectively.
7. Passing the wire through the knockout, insert the Ground AC output wire into the Ground terminal slot on the unit.
8. Repeat steps 5 to 7 for Line and Neutral connections.
Tighten the wire attachment screws to a torque of 1.3–1.8 lbf-ft (1.76–2.44 Nm). Leave some wiring slack inside the wiring compartment.
Ensure you have maintained correct polarity and that there are no loose strands of wire.

REVERSE POLARITY DAMAGE

Make sure the wires are connected properly. Improper connections (connecting a line conductor to a neutral conductor, for example) will cause the Freedom HF to malfunction and may permanently damage the inverter. Damage caused by a reverse polarity connection is not covered by your warranty.

Failure to follow these instructions can damage the unit and/or damage other equipment.

9. Secure the wires by adjusting the strain-relief clamp.
10. Install the GFCI back into the front panel of the unit.
11. Alternatively, if you do not reinstall the GFCI, make sure that you cap the exposed wires and install a blanking plate to cover the space vacated by the GFCI.
12. Connect the other end of the wires to a circuit breaker in the inverter distribution panel.

This guide for use by qualified personnel only.

Basic Installation Procedures

Step 6: Connecting the DC Cables

The following instructions only apply to the following models: Freedom HF 1000, Freedom HF 1055, Freedom HF 1800, and Freedom HF 1800 T.

NOTICE

REVERSE POLARITY DAMAGE

Check cable polarity at both the battery and the Freedom HF before making the final DC connection. Positive must be connected to positive; negative must be connected to negative.

Reversing the positive and negative battery cables will damage the Freedom HF and void your warranty.

Failure to follow these instructions can damage the unit and/or damage other equipment.

⚠ WARNING

FIRE HAZARD

Use only copper wire rated 75 °C minimum. Make sure all DC connections are tight to a torque of 108–120 inch-pounds (12.2–13.6Nm). Loose connections will overheat.

Failure to follow these instructions can result in death or serious injury.

Follow the procedure given below to connect the battery leads to the terminals on the DC end. The cables should be as short as possible and large enough to handle the required current, in accordance with the electrical codes or regulations applicable to your installation. Table 2 on page 10 specifies the minimum DC cable size and maximum fuse size for the Freedom HF.

Do not route your DC cables through an electrical distribution panel, battery isolator, or other device that will cause additional voltage drops.

Figure 5 shows the DC end for your reference.

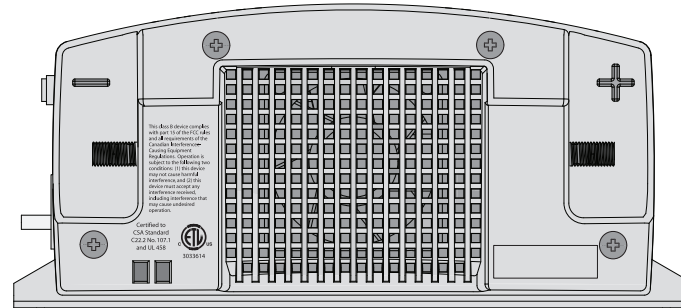

Figure 5 DC End for Freedom HF 1000, 1055, 1800, and 1800 T

Basic Installation Procedures

To make the DC connections

Refer to Figure 6.

1. Make sure the inverter is off and no AC or DC is connected to the unit.
2. Remove the nuts and washers from the Freedom HF positive and negative DC terminals.
3. Strip 1/2 inch (13 mm) to 3/4 inch (19 mm) insulation from one end of each cable. The amount stripped off will depend on the terminals chosen.
4. Attach the connectors that will secure the cables to the battery, to the disconnect/battery selector switch, and the fuse block. The connectors you use must create a permanent, low-resistance connection.
If crimp connectors are required, it is recommended to use approved and certified connectors, and to use the tool recommended by the terminal manufacturer. Make sure no stray wires protrude from the connector or terminal. (You may find it more convenient to have the crimp connectors attached by the company that sells you the cable and/or connectors.)
5. For each cable end that will be connected to the inverter, strip 1/2 inch (13 mm) to 3/4 inch (19 mm) of insulation from the cable. The amount stripped off will depend on the terminals chosen.

6. Thread a supplied DC terminal cover over the positive and negative cables. The red cover goes on the positive cable; the black cover on the negative cable.
7. Attach the connector that will join the cable to the inverter DC terminal.
8. Install a fuse and fuse holder in the cable that will be used for the positive side of the DC circuit.
The fuse must:
 - be as close to the battery positive terminal as possible
 - be rated for DC circuits
 - have an Ampere Interrupting Capacity (AIC) that exceeds the short-circuit current available from the battery (i.e., Class T fuse)
9. To prevent sparking when making the connection, ensure the disconnect/battery selector switch is off.
10. Attach the connector on the positive cable to the positive DC terminal on the inverter.
11. Install the lock washer and nut that are supplied with the inverter. Tighten the nut to a torque of 108–120 in-lbf (12.2–13.6 N-m). Make the connection snug enough so the ring terminal does not move around on the DC terminal, but do not overtighten. See Figure 6, “DC Cable Connections” on page 25.

This guide for use by qualified personnel only.

Basic Installation Procedures

NOTICE

EQUIPMENT DAMAGE

Tighten the nuts on terminals properly. Loose connections cause excessive voltage drop and may cause overheated wires and melted insulation.

Do not over-tighten the nut on the DC input terminals. Damage to the DC input terminals may result. The maximum torque setting is **120 in-lbf (13.6 N-m)**.

Failure to follow these instructions can damage the unit and/or damage other equipment.

NOTICE

REVERSE POLARITY DAMAGE

Check cable polarity at both the battery and the Freedom HF before making the final DC connection. Positive must be connected to positive; negative must be connected to negative.

Reversing the positive and negative battery cables will blow a fuse in the Freedom HF and void your warranty.

Failure to follow these instructions can damage the unit and/or damage other equipment.

12. Before proceeding, double check that the cable you have just installed connects the positive DC terminal of the inverter to the disconnect/battery selector switch, fuse holder, and that the other end of the fuse holder is connected to the positive terminal of the battery.

⚠ WARNING

FIRE HAZARD

Do not complete the next step if flammable fumes are present. Explosion or fire may result if the disconnect/battery selector switch is not in the off position. Thoroughly ventilate the battery compartment before making this connection.

Failure to follow these instructions can result in death or serious injury.

13. Connect the cable from the negative post of the battery to the negative DC terminal of the inverter.
14. Install the lock washer and nut that are supplied. Tighten the nut to a torque of 108–120 in-lbf (12.2–13.6 N-m). Make the connection snug enough so the ring terminal does not move around on the DC terminal, but do not overtighten.
15. Slip the DC terminal covers over the Freedom HF DC terminals.

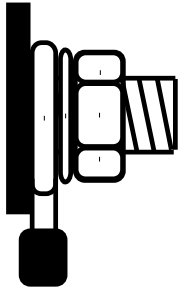

Figure 6 DC Cable Connections

Anderson Connectors

The Freedom HF 1055 EMS and 1800 EMS models are pre-wired with an Anderson¹ connector that attaches to matching terminal connectors in certain trucks and vehicles.

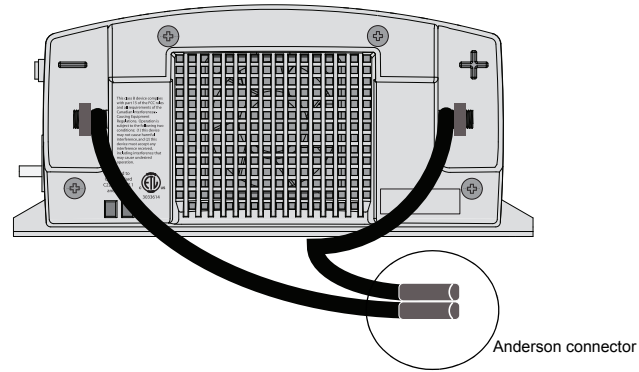

Figure 7 DC End for Freedom HF 1055 EMS and 1800 EMS

This guide for use by qualified personnel only.

1. Anderson Power Products® manufactures power interconnects and accessories. An Anderson connector is a term used in this manual to mean a connector manufactured by Anderson Power Products and refers to either SB175 or SB350.

Basic Installation Procedures

DC Grounding

To connect the DC ground:

The equipment grounding lug on the DC end of the Freedom HF is used to connect the chassis of the Freedom HF to your system's DC negative connection or grounding bus point as required by electrical regulations. Use copper wire that is either bare or provided with green insulation. Do not use the DC Ground Lug for your AC grounding. (See the AC wiring instructions in this section.)

Follow the guidelines below that correspond to the specific type of installation. These guidelines assume you are using the DC supply cable and fuse sizes recommended in this manual. If you are using different sizes, refer to the applicable installation code for DC grounding details.

Recreational Vehicle Use 8AWG copper wire and connect it between the Chassis Ground lug and the vehicle's DC grounding point (usually the vehicle chassis or a dedicated DC ground bus).

Marine Use copper wire that is bare or has insulation rated minimum 105 °C, and connect it between the Chassis Ground lug and the boat's DC grounding bus or engine negative bus. For the Freedom HF 1000, use a wire of gauge 4AWG minimum. For the Freedom HF 1500, use a wire of gauge 2AWG minimum. For the Freedom HF 1800, use a wire of gauge 1/0AWG minimum.

Inverter Ignition Control (For Freedom HF 1000, 1055, 1500, 1800, and 1800 T)

The Freedom HF can be wired to inhibit inverter operation in the absence of a vehicle's (or vessel's) ignition control signal. This feature can avoid unnecessary battery drain that would otherwise occur if the inverter was operated without a charging source such as the vehicle alternator. The feature is standard on the Freedom HF platform.

To enable ignition control:

1. Ensure that AC and DC power are both OFF.
2. Ensure the vehicle's ignition is turned to OFF position. It is highly recommended to remove battery power by disconnecting the vehicle's battery cables. Refer to the vehicle's Owner's Guide for proper instructions on how to disconnect the battery cables.
3. Locate the vehicle's ignition control wire from the vehicle's ignition circuit. This wire must be fused appropriately at no more than five amps. Refer to the vehicle's Owner's Guide for guidance.
4. Using a #1 Phillips screw driver, remove the screw securing the DC wiring cover on the left hand side of the unit.

Basic Installation Procedures

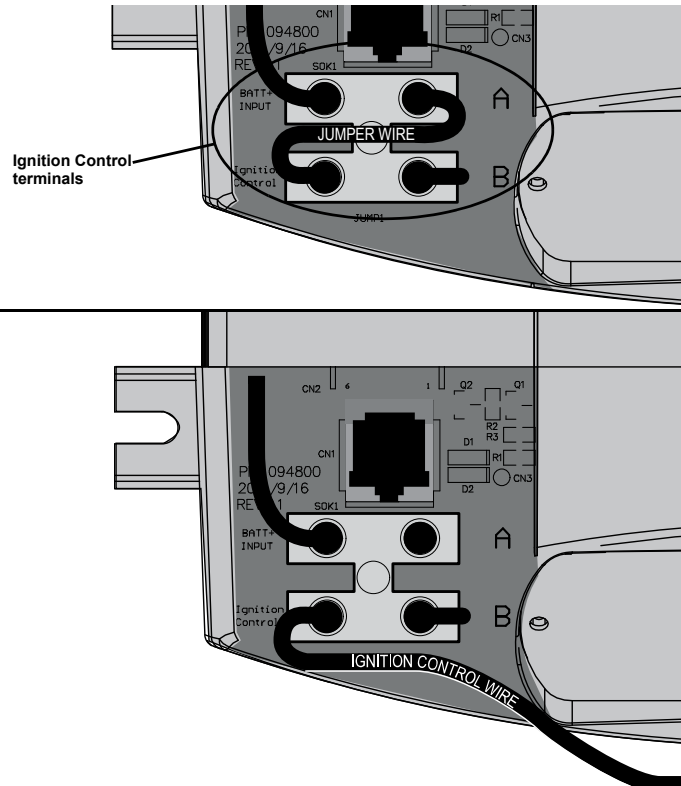

5. Remove the DC wiring cover to expose the ignition control terminals of the DC wiring compartment.
6. Unscrew and remove the red jumper wire, using a flat screw driver, in between terminal **A** and terminal **Ignition Control**. The jumper wire acts to disable ignition control and removing it will enable it.
7. Strip the vehicle's ignition control wire and connect it to terminal **Ignition Control**.
NOTE: Do not make any external connections to terminal **A**. This can result in non-warranty damage to the unit.
8. Route the ignition control wire to the left side of the display panel.
9. Replace the DC wiring cover onto the DC wiring compartment. The ignition control wire should pass-through the hole on the side of the DC wiring cover.

This guide for use by qualified personnel only.

Figure 8 Exposed Ignition Control Terminals

Basic Installation Procedures

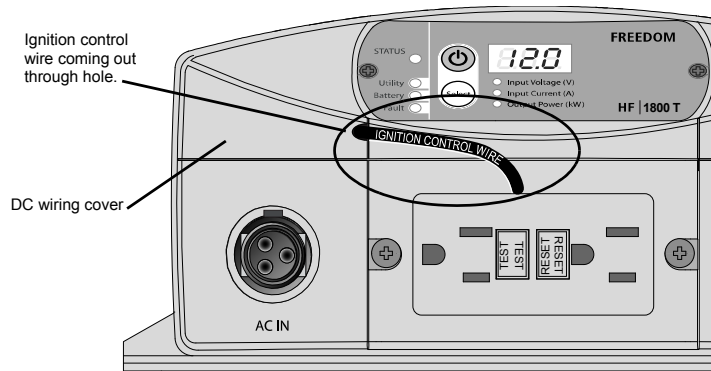

Power Module (For Freedom HF 1055 EMS and 1800 EMS)

In addition to having the ability to inhibit inverter operation in the absence of a vehicle's (or vessel's) ignition control signal, the Freedom HF 1055 EMS and 1800 EMS models also have the ability to provide auxiliary DC power from the battery for small loads not exceeding 20 amps DC in total. Auxiliary DC power is provided when the same ignition control signal is present. This means that the vehicle's ignition is turned to ON position. The unit internally connects the **DC OUT** terminal to the battery's positive terminal.

To enable ignition control and to connect auxiliary DC power:

1. Ensure that AC and DC power are both OFF.
2. Ensure the vehicle's ignition is turned to OFF position. It is highly recommended to remove battery power by disconnecting the vehicle's battery cables. Refer to the vehicle's Owner's Guide for proper instructions on how to disconnect the battery cables.
3. Locate the vehicle's ignition control wire from the vehicle's ignition circuit. This must be fused appropriately at no more than five amps. Refer to the vehicle's Owner's Guide for guidance.
4. Choose an auxiliary DC appliance that will be ignition controlled. The appliance must be rated at 12 volts.

Basic Installation Procedures

5. Unscrew and remove the red jumper wire, using a small flat screw driver, in between the terminals **Ignition Control** and **Disabled**. The jumper wire acts to disable ignition control and removing it will enable it.

6. Strip the vehicle's ignition control wire and connect it to the middle terminal **Ignition Control**.
NOTE: Do not make any external connections to terminal **Disabled**. This can result in non-warranty damage to the unit.
7. Locate wiring for the auxiliary DC appliance that will be ignition controlled. Use a minimum of 10 AWG wire.
8. Strip the auxiliary DC wire and connect it to the left-most terminal **DC OUT 12V, 20A**.

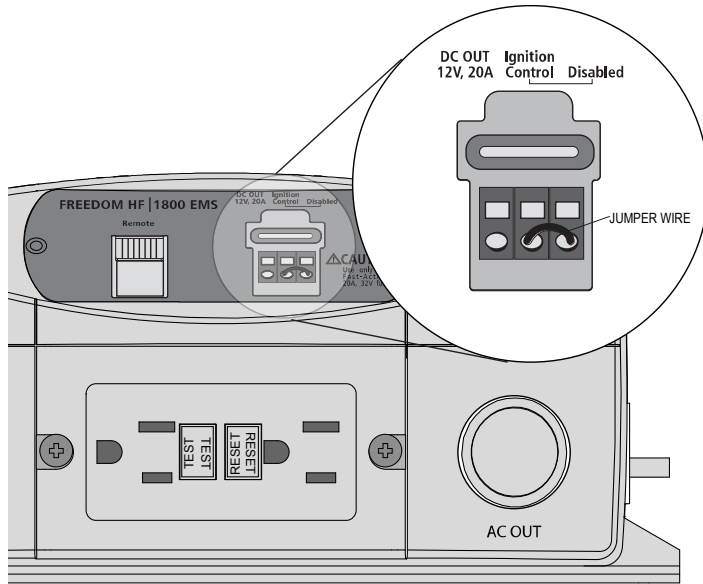
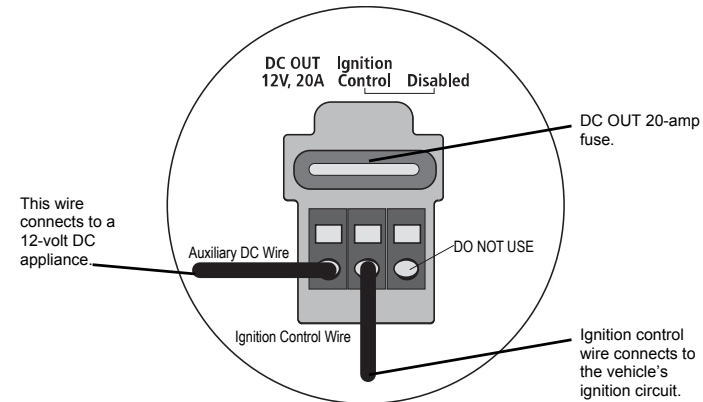
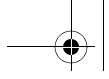

Figure 9 Power Module for EMS Models



9. Connect the other end of the auxiliary DC wire to the DC appliance.

This guide for use by qualified personnel only.



Basic Installation Procedures

10. Reconnect the battery cables of the vehicle. Refer to the vehicle's Owner's Guide for proper instructions on how to reconnect the battery cables.
11. Turn the vehicle's ignition to the ON position.
12. Turn the DC appliance on. Otherwise, if the DC appliance does not have a switch it should automatically turn on at this point.

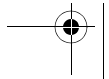
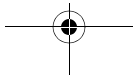
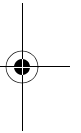
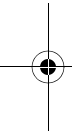

Step 7: Mounting the Display Panel

The communications cable supplied with the display panel is 25 feet (7.62 meters) long. If you want to replace the cable with one that is shorter, use a high quality, six-wire telephone extension cable.

Flush mounting the panel on a wall or bulkhead requires an opening that is approximately 3.25×1.25 inches (8.25×3.18 cm). About 1.5 inches (3.81 cm) of free space is required within the wall to accommodate the depth of the panel. Be sure there is no wiring or other obstructions within the wall before you make an opening.

To mount the display panel:

1. Choose a location that is dry, out of direct sunlight, free from corrosive or explosive fumes, and otherwise appropriate for mounting an electronic device.
2. Tape the mounting template (in the Freedom HF package) to the mounting surface and mark the locations of the mounting holes and the area to be cut away.
3. Pilot-drill the mounting holes and cut out the hole in which the panel will be inserted.
4. Route the communications cable(s) inside the wall and through the opening.
5. Insert one of the cable's connectors in either jack on the bottom of the panel.
6. Place the panel in the opening and secure it with appropriate fasteners.
7. Route the communications cable to the Freedom HF and insert the connector in the jack located near the battery select dip switch.

IMPORTANT: Do not route the communications cable in parallel and in conduit with the AC and DC wires. In situations where the cable must cross with the AC and DC wires, make sure they cross at a 90° angle to each other.

This guide for use by qualified personnel only.

Basic Installation Procedures

Step 8: Testing Your Installation

WARNING

ELECTRICAL SHOCK HAZARD

Pressing the Inverter button to turn OFF the Freedom HF inverter function on display panel does not disconnect DC or AC input power to the Freedom HF. If shore power is present at AC input terminals, it will pass through to the AC output.

Failure to follow these instructions can result in death or serious injury.

There are two tests to be performed. The first test verifies that the Freedom HF is inverting DC battery power and delivering AC power to its output.

The second test is intended for installations where AC input and output is hard wired to the Freedom HF. This test verifies that the Freedom HF transfers from inverter power to shore power when shore power is present.

NOTE: Shore power (pass-through) refers to the AC input power from a utility grid, generator or external AC source.

When you are ready to test your installation and operate the Freedom HF, close the DC fuse and Disconnect or the DC circuit breaker to supply DC power to the Freedom HF.

Testing in Invert Mode

To test the Freedom HF in invert mode:

1. For hard wired installations, ensure shore power is not present.
2. Press the Inverter button to turn the inverter on.
The status LED on the display panel glows yellow and the LED display illuminates.
3. Plug an appliance within the power rating of the inverter into the Freedom HF GFCI or an AC outlet hard wired to the Freedom HF.
4. Turn the appliance on to verify that it operates.

If the appliance operates, your installation is successful. If your installation has AC input and output hard wired to the Freedom HF, proceed to “Testing in Shore Power Mode”.

If the status LED on the display panel glows red, see the Troubleshooting chapter.

Testing in Shore Power Mode

To test the Freedom HF in shore power mode:

- ◆ With the appliance from the previous test still connected and operating, connect the shore power source.

The Freedom HF transfers the appliances to shore power. The status LED on the display panel will change from yellow to a ten-second flashing yellow and then green.

If the appliance operates, your installation is successful.

NOTE: If the Inverter button on the Freedom HF is turned ON, the Freedom HF will automatically supply the appliances with inverter power if the shore power source fails or becomes disconnected.

If the Inverter button on the Freedom HF is turned ON and shore power voltage is too low (less than 90 volts AC), the unit will transfer to inverter power to continue running your appliances.

NOTE: Whether or not the Inverter button is turned ON, shore power will pass through the Freedom HF to the output when shore power is within normal operating range.

This guide for use by qualified personnel only.

Drip Shield Installation (For Marine Installations)

The drip shield helps to protect the unit from dripping or splashing liquids, which will cause a shock hazard. Drip shields are especially useful in marine installations where water from condensation, rain, or sea may come into contact with the Freedom HF.

WARNING

ELECTRICAL SHOCK HAZARD

Use this product in dry areas only. Operating the unit under wet conditions may expose you to a shock hazard. Installing drip shields may not entirely protect you from this hazard. Do not operate the unit when it is wet.

Failure to follow these instructions can result in death or serious injury.

You may purchase the drip shield set by contacting customer support. When ordering, mention part number 808-9531.

Different Views

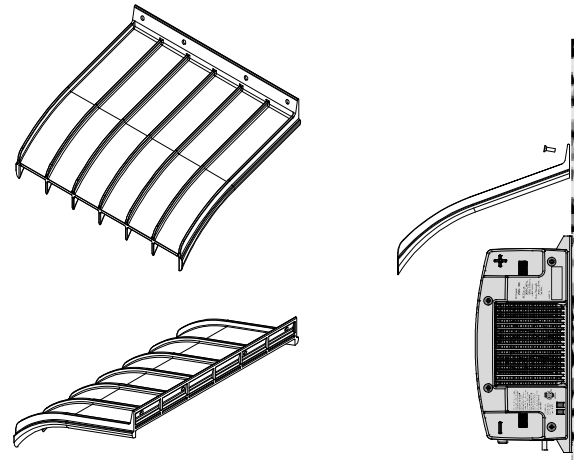

Drip Shield set part# 808-9531

Figure 10 Drip Shields

Drip Shield Installation (For Marine Installations)

To install the drip shields:

1. Gather the four screws needed to fasten a single drip shield to a wall.
2. Locate an appropriate setting for the drip shields above the Freedom HF making sure you cover the entire width of the unit. You can overlay the shields as shown in Figure 11 below.
3. Fasten the screws through the holes in the drip shield into the wall. See Figure 10.

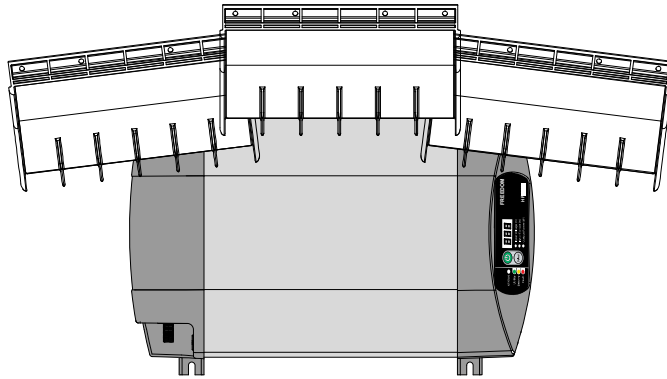
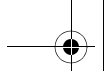

Figure 11 Typical Drip Shield Placement on a Freedom HF 1800

This guide for use by qualified personnel only.



Configuration

Refer the Owner's Guide for instructions on configuring the battery type accepted by the unit and on adjusting display, alarm, and charging current settings.

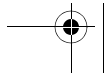
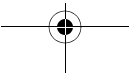
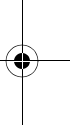
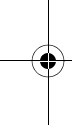

Marine Installation

Figure 12 illustrates a typical marine installation with the following components:

1. AC power supplied from a shore power connector
2. An AC source panel that includes a Max 30A circuit breaker that supplies the Freedom HF
3. An AC load panel with branch circuit breakers that supply only loads that run off the Freedom HF
4. Engine negative bus / DC ground bus
5. DC power supplied by a battery bank and protected by a DC fuse in the positive cable
6. Battery isolator
7. DC alternator
8. Starting battery
9. Drip shield (not shown)

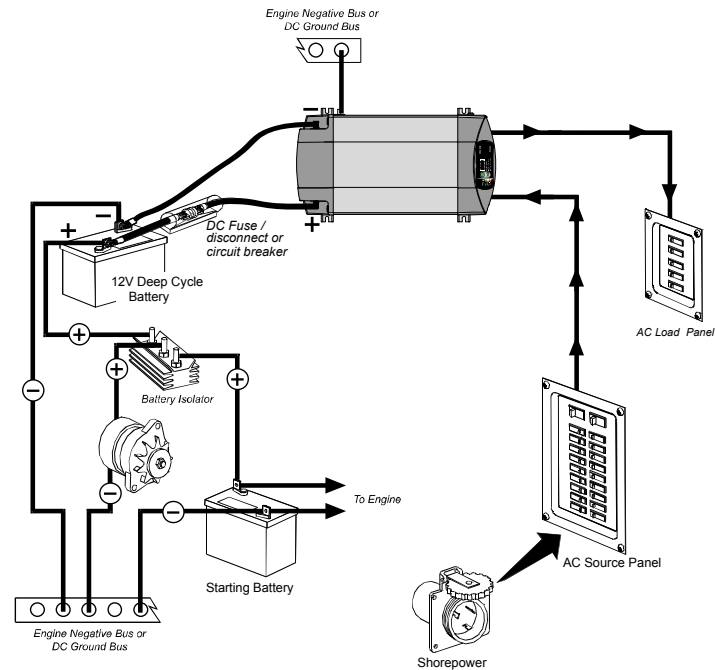

This guide for use by qualified personnel only.

Figure 12 Typical Marine Installation

Specifications

NOTE: Specifications are subject to change without prior notice.

Physical Specifications	1000-watt models	1500 and 1800-watt models
L × W × H	15.5" (393mm) × 9.5" (241mm) × 4.2" (106mm)	18" (457mm) × 9.5" (241mm) × 4.2" (106mm)
Net Weight	10 lbs (4.5 kg)	12.8 lbs (5.8 kg)

NOTE: Excludes any external AC or DC wiring harnesses included on some models.

Environmental Specifications	1000-watt models	1500 and 1800-watt models
Ambient Temperature:	0–40 °C	
Operating Temperature Range	-20–60 °C, with output derated above 25 °C	
Storage Temperature Range	-40–70 °C	
Humidity: Operation/Storage	5–95% RH, non-condensing	
Ambient Temperature:	0–40 °C	
Operating Temperature Range	-20–60 °C, with output derated above 25 °C	
Storage Temperature Range	-40–70 °C	

System Specifications	1000-watt models	1500 and 1800-watt models
Transfer relay rating	30A, 2.0hp	
Transfer time	<30ms (milliseconds)	
Transfer on bad voltage	90–100V for low AC and 130–140 for high AC	
Cooling	Fan, activated by any of the following: <ul style="list-style-type: none"> •High internal temperature •High AC output power 	

NOTE: These specifications refer to inverter mode.

DC Input	1000-watt models	1500 and 1800-watt models
Operating voltage range for all models	10.5–15.5 VDC (low limit) 11.8–15.5 VDC (high limit)	10.5–15.5 VDC (low limit) 11.8–15.5 VDC (high limit)
Operating voltage range for Freedom HF 1500 and Freedom HF 1800 T	n/a	10.5–15.5 VDC (low limit) 11.8–15.5 VDC (mid limit) 12.1–15.5 VDC (high limit)
Safe non-operating voltage range	0–16 VDC	0–16 VDC
Normal voltage for all models	12.5 VDC	12.5 VDC
Nominal current at full load	100 ADC	180 ADC
AC Output	1000-watt models	1500 and 1800-watt models
Output voltage	115 VAC	115 VAC
Continuous power	1.0kW @ 25 °C	1.8kW @ 25 °C 1.5kW @ 25 °C (Freedom HF 1500 only)
Surge power	17 A (2kW for 200 ms)	30 A (3.6kW for 300 ms)
Max short-circuit current	55 A peak	55 A peak
Frequency	60 Hz	60 Hz
Wave shape	Modified Sine Wave	Modified Sine Wave
Power derating above 40 °C ambient temp	See “Invert Power Derating vs. Ambient Temperature” on page 31.	
Peak efficiency	≥87%	≥87%
Full load efficiency	≥80%	≥80%
Other	1000-watt models	1500 and 1800-watt models
No load input power (producing output voltage)	≤10W	≤10W
Off mode current draw	≤1mA	≤1mA

This guide for use by qualified personnel only.

Specifications

NOTE: These specifications refer to charger mode.

AC Input	1000-watt models	1500 and 1800-watt models
Operating voltage range for all models	90–130 VAC	90–130 VAC
Operating voltage range for Freedom HF 1500 and Freedom HF 1800 T	5 A at 20 A charge, 120 VAC IN	10 A at 40 A charge, 120 VAC IN
Nominal current	5 A at 20 A charge, 120 VAC IN	10 A at 40 A charge, 120 VAC IN
Nominal frequency	60 Hz	60 Hz
DC Output	1000-watt models	1500 and 1800-watt models
Nominal voltage	12.0 VDC	12.0 VDC
Min battery voltage for charging	0.0 VDC	0.0 VDC
Max output voltage	14.4 VDC	14.4 VDC
Nominal output current	User selectable: 2A, 5A, 10A, 20A (Freedom HF 1000) 5A, 15A, 35A, 55A (Freedom HF 1055)	User selectable: 2A, 10A, 20A, 40A
Charger current derating	Charger current will automatically derate as internal temperature exceeds 80 °C.	Charger current will automatically derate as internal temperature exceeds 80 °C.
Efficiency at nominal output	≥75%	≥75%
Other	1000-watt models	1500 and 1800-watt models
No load input power (producing output voltage)	≤10W	≤10W
Off mode current draw	≤1mA	≤1mA
Regulatory Approvals	1000-watt models 1500 and 1800-watt models	
	ETL approved to CSA 107.1, UL458, and UL458 Marine Supplement (drip shield with product number 808-9531 required).	



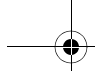

**Schneider Electric Solar
Inverters USA Inc.**

+1 800 670 0707
+1 408 987 6030
www.xantrex.com



975-0395-01-01

Printed in China

