

Smart choice for power™

xantrex™

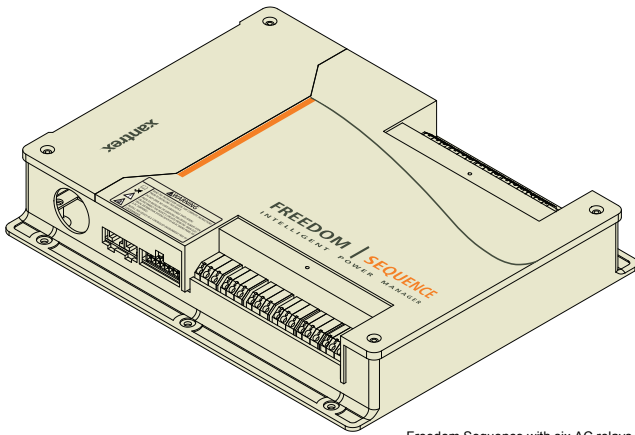

Freedom Sequence with six AC relays
PN: 809-0912 shown.

Installation Guide

Freedom Sequence

Intelligent Power Manager

PNs: 809-0912
809-0913

xanbus
E N A B L E D

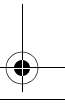
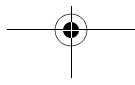
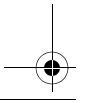
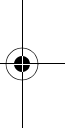
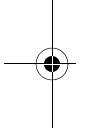

Trademarks

Xantrex and **Smart choice for power** are trademarks of Schneider Electric Services International sprl, registered in the United States and other countries. Other trademarks, registered trademarks, and product names are the property of their respective owners and are used herein for identification purposes only.

Notice of Copyright

Freedom Sequence Intelligent Power Manager Installation Guide © August 2011 Xantrex Technology USA Inc. All rights reserved. No part of this document may be reproduced in any form or disclosed to third parties without the express written consent of: Xantrex Technology USA Inc., 541 Roske Drive, Suite A, Elkhart, Indiana USA 46516. Xantrex Technology USA Inc. reserves the right to revise this document and to periodically make changes to the content hereof without obligation or organization of such revisions or changes unless required to do so by prior arrangement.

Exclusion for Documentation

UNLESS SPECIFICALLY AGREED TO IN WRITING, XANTREX TECHNOLOGY USA INC. ("XANTREX")

- (A) MAKES NO WARRANTY AS TO THE ACCURACY, SUFFICIENCY OR SUITABILITY OF ANY TECHNICAL OR OTHER INFORMATION PROVIDED IN ITS MANUALS OR OTHER DOCUMENTATION;
- (B) ASSUMES NO RESPONSIBILITY OR LIABILITY FOR LOSSES, DAMAGES, COSTS OR EXPENSES, WHETHER SPECIAL, DIRECT, INDIRECT, CONSEQUENTIAL OR INCIDENTAL, WHICH MIGHT ARISE OUT OF THE USE OF SUCH INFORMATION. THE USE OF ANY SUCH INFORMATION WILL BE ENTIRELY AT THE USER'S RISK; AND
- (C) REMINDS YOU THAT IF THIS MANUAL IS IN ANY LANGUAGE OTHER THAN ENGLISH, ALTHOUGH STEPS HAVE BEEN TAKEN TO MAINTAIN THE ACCURACY OF THE TRANSLATION, THE ACCURACY CANNOT BE GUARANTEED. APPROVED XANTREX CONTENT IS CONTAINED WITH THE ENGLISH LANGUAGE VERSION WHICH IS POSTED AT WWW.XANTREX.COM.

Date and Revision

August 2011 Rev B

To view, download, or print the latest revision, visit the website shown under Contact Information.

Document Part Number

975-0594-01-01

975-0594-01-01

Product Numbers

809-0912 (Six AC relays)
809-0913 (Four AC relays)

Contact Information

Telephone: 1 800 670 0707
Fax: 1 800 994 7828
Web: www.xantrex.com

This guide for use by qualified installers only.

About This Guide

Purpose

The purpose of this Installation Guide is to provide procedures for installing and wiring the Freedom Sequence Intelligent Power Manager.

Scope

The guide provides installation and mounting instructions, as well as information on wiring the power manager.

It does not provide details about certain components that can be attached to the power manager. You need to consult the individual component's owner's guide for this information.

Audience

The guide is intended for qualified installers who need to install and mount any unit model of the Freedom Sequence Intelligent Power Manager. The installer should have knowledge and experience in installing electrical equipment, knowledge of the applicable installation codes, and awareness of the hazards involved in performing electrical work and how to reduce those hazards. A qualified technician or electrician has this knowledge and experience.

Conventions Used

The following conventions are used in this guide.

DANGER

STATEMENT OF HAZARD

Contains statements of avoidance or strict compliance.

Failure to follow these instructions will result in death or serious injury.

WARNING

STATEMENT OF HAZARD

Contains statements of avoidance or strict compliance.

Failure to follow these instructions can result in death or serious injury.

CAUTION

STATEMENT OF HAZARD

Contains statements of avoidance or strict compliance.

Failure to follow these instructions can result in minor or moderate injury.

CAUTION

STATEMENT OF HAZARD

Contains statements of avoidance or strict compliance.

Failure to follow these instructions can damage the unit and/or damage other equipment.

IMPORTANT: These notes describe things which are important for you to know, however, they are not as serious as a danger, warning, or caution.

Related Information

You can find more information about Xantrex Technology USA Inc. as well as its products and services at **www.xantrex.com**.



The product marking on the left when found imprinted on electrical and electronic units and appliances means that you are to refer to this guide for cautions and warnings.

This guide for use by qualified installers only.

Important Safety Instructions

IMPORTANT: READ AND SAVE THIS INSTALLATION GUIDE FOR FUTURE REFERENCE.

This chapter contains important safety instructions when operating the Freedom Sequence Intelligent Power Manager. Each time, before using the Freedom Sequence Intelligent Power Manager, READ ALL instructions and cautionary markings on or provided with the power manager and all appropriate sections of this guide.

NOTE: The Freedom Sequence Intelligent Power Manager contains no user-serviceable parts. For obtaining service, see “Warranty and Return Information” on the Owner’s Guide for guidance.

NOTE: The Freedom Sequence Intelligent Power Manager must be provided with grounding conductors connected to the AC input/output connections.

DANGER

ELECTRICAL SHOCK HAZARD

- Do not expose the power manager to rain, snow, spray, or bilge water.
- Do not operate the power manager if it has received a sharp blow, been dropped, has cracks or openings in the enclosure, or will not close, or otherwise damaged in any other way.
- Do not disassemble the power manager.
- Disconnect both AC and DC power from the power manager before attempting any maintenance or cleaning or working on any circuits connected to the power manager. See note below.
- Do not operate the power manager with damaged or substandard wiring. Make sure that all wiring is in good condition and is not undersized. Use copper conductors only.

Failure to follow these instructions will result in death or serious injury.

NOTE: The power manager has no on/off switch. Circuits are always live when DC and AC input are present.

⚠ DANGER

EXPLOSION HAZARD

Do not work in the vicinity of lead-acid batteries. Batteries generate explosive gases during normal operation. See note below.

Failure to follow these instructions will result in death or serious injury.

NOTE: Follow these instructions and those published by the battery manufacturer and the manufacturer of any equipment you intend to use in the vicinity of the battery. Review cautionary markings on these products and on the engine.

⚠ WARNING

PERSONAL INJURY HAZARD

This power manager is not intended for use by persons (including children) with reduced physical, sensory, or mental capabilities or lack of experience and knowledge, unless they have been given supervision or instruction concerning use of the appliance by a person responsible for their safety. Children should be supervised to ensure that they do not play with the power manager.

Failure to follow these instructions can result in death or serious injury.

Precautions When Placing the Power Manager

⚠ DANGER

EXPLOSION HAZARD

Do not place the power manager in machinery space or in areas containing gasoline tanks or fittings in which ignition-protected equipment is required.

This equipment is intended for installation in accordance with the National Electrical Code, NFPA 70.

Failure to follow these instructions will result in death or serious injury.

⚠ WARNING

ELECTRICAL SHOCK HAZARD

To reduce the risk of fire or electric shock, install in a controlled environment relatively free of contaminants.

Failure to follow these instructions can result in death or serious injury.

NOTE: A controlled environment is an environment that is relatively free of solid airborne particulates, liquid, and/or gaseous elements. A controlled environment may also be provided by means of a totally closed, gasketed enclosure or the equivalent.

This guide for use by qualified installers only.

CAUTION

RISK OF DAMAGE TO THE POWER MANAGER

- Never place the Freedom Sequence Intelligent Power Manager unit directly above batteries; gases from a battery will corrode and damage the power manager.
- Do not place a battery on top of the power manager.

Failure to follow these instructions can damage the unit and/or damage other equipment.

FCC Information to the User

This equipment has been tested and found to comply with the limits for a Class B digital device, pursuant to part 15 of the FCC Rules. These limits are designed to provide reasonable protection against harmful interference in a residential installation. This equipment generates, uses, and can radiate radio frequency energy and, if not installed and used in accordance with the instructions, may cause harmful interference to radio communications.

However, there is no guarantee that interference will not occur in a particular installation. If this equipment does cause harmful interference to radio or television reception, which can be determined by turning the equipment off and on, the user is encouraged to try to correct the interference by one or more of the following measures:

- Reorient or relocate the receiving antenna.
- Increase the separation between the equipment and receiver.
- Connect the equipment into an outlet on a circuit different from that to which the receiver is connected.
- Consult the dealer or an experienced radio/TV technician for help.

CAUTION

Unauthorized changes or modifications to the equipment could void the user's authority to operate the equipment.



Contents

Important Safety Instructionsiv

Introduction 1

Features 5

Installing the Freedom Sequence 11

Freedom Sequence SCP Menu Map. 18

Specifications 19

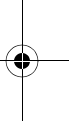
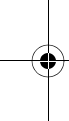



Introduction

The Xantrex Freedom Sequence Intelligent Power Manager is a fully integrated power management system (sometimes referred to as EMS or energy management system) that provides automatic power and load management for use in recreational vehicles (RV) while receiving power from a generator or shore power. The Freedom Sequence power manager optimizes the available current capacity from an AC electrical source to power as many connected AC loads as possible. It makes decisions on which loads get power based on a priority base set by the installer¹.

Standard Features

- Manage power for single or split-phase AC sources up to 50 amps including 15-, 20-, 30-, and 50-amp shore and generator power sources.
- Fully user configurable AC and DC load management system using the Xanbus System Control Panel (SCP).
- Monitor current draw and On/Off status for each AC load circuit, including the current draw from the main AC source (shore or generator power).
- Has six AC relays (PN: 809-0912) or four AC relays (PN: 809-0913) via the AC relay terminal blocks which can control AC load circuits rated up to 15 amps each.
- Four DC relays (via the DC auxiliary connector port) which can control external DC circuits based on Battery Voltage. These four DC relays can also be used to control external AC circuits².
- Circuit level override from load-shed³ and priority swapping⁴, directly accessible via the SCP.
- Sequential engaging of AC loads for generator soft-start that eliminates heavy inrush demand.
- Seamless integration with Freedom SW Inverter/Chargers to provide charger derating, automatic inverter assist, and auto-detect generator run conditions and reset breaker rating from Shore to Generator breaker rating.

This guide for use by qualified installers only.

1.The installer should have knowledge and experience in installing electrical equipment, knowledge of the applicable installation codes, and awareness of the hazards involved in performing electrical work and how to reduce those hazards. A qualified technician or electrician has this knowledge and experience.

2.External AC circuits are AC loads that are not directly controlled through the Freedom Sequence's available six (or four) AC relays.

3.Load shedding is defined as cutting power to loads that are drawing current from the system in order to avoid an overload condition.

4.Priority swapping is defined as the automatic prioritization of loads when one load has been assigned a different priority number.

Introduction

Material List

The Freedom Sequence ships with the following items:

- one Freedom Sequence unit,
- owner's and installation guides,
- DC auxiliary connector wiring harness,
- AC wiring terminal covers with screws, and
- a Xanbus network terminator.

NOTE: Keep the carton and packing material in case you need to return the power manager for servicing.

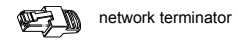
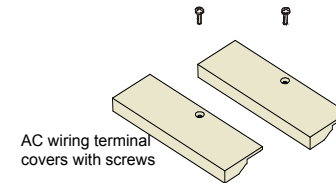
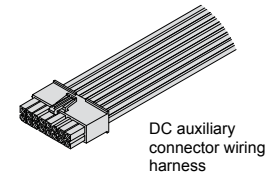
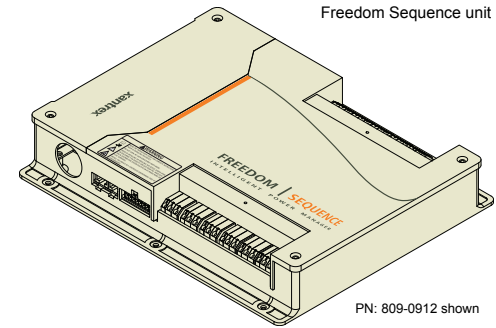

Compatible Products and Accessories¹

Product/Accessory	Product Number
Freedom SW Series Inverter/Charger (12 and 24-volt systems)	815-2012, 815-2024 (2kW) 815-3012, 815-3024 (3kW)
Xanbus System Control Panel (SCP)	809-0921
Xanbus Automatic Generator Start (AGS)	809-0915
25-ft network cable for SCP	809-0940
75-ft network cable for SCP	809-0942

The Xanbus System Control Panel (SCP) enables you to monitor and control all the power components of the Freedom Sequence power manager from a single easy-to-use interface.

The Xanbus Automatic Generator Start (AGS) is a panel and a control module system that provides automatic activation for your generator. If the AGS is present in the Xanbus network, the power manager does not need the Generator Run signal (also known as switched B+ signal) to be hardwired to the generator for it to receive generator-run conditions.

Together with the Freedom SW Series Inverter/Charger, the power manager provides advanced power optimization features of interactive charger de-rating and automatic inverter assist to provide additional power to support high peak power demands.

Freedom inverter/charger

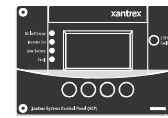
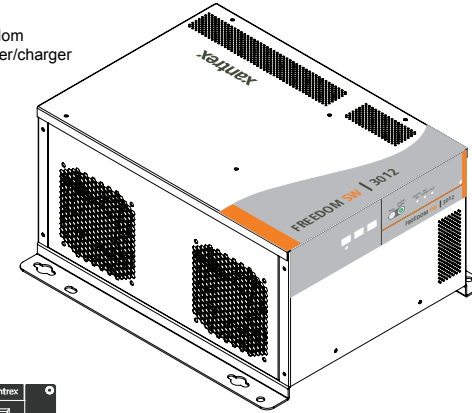

SCP



25-ft cable

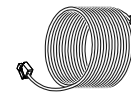

75-ft cable

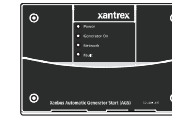

AGS

This guide for use by qualified installers only.

¹.For an updated list, visit www.xantrex.com.

Introduction

Xanbus System

The Xanbus system includes the Freedom SW Series Inverter/Charger and other Xanbus-enabled devices. The inverter/charger is the device in a Xanbus system that typically provides network power—500 mA at 12 volts DC. When Freedom Sequence is present in the network, it can also provide the power for the whole Xanbus network. All of the Xanbus-enabled devices, such as Freedom Sequence, the SCP, and the AGS are able to communicate their settings and activity to each other. See Figure 1.

The Xanbus-enabled designation (see below) means that this product works on a Xanbus network. Xanbus-enabled products are:

- Simple to operate and routine tasks are automated,
- Controlled by software that eliminates analog signalling errors,
- Less susceptible to interference and line loss, and
- Upgradable through new software releases.

xanbus
E N A B L E D

For detailed instructions and a complete list of Xanbus-enabled devices, visit www.xantrex.com.

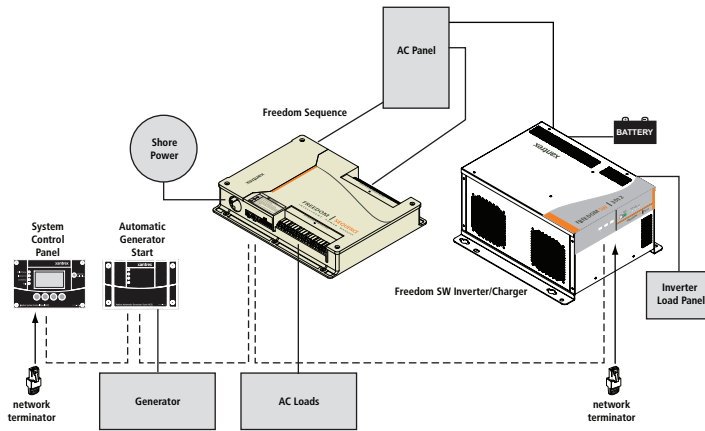

Figure 1 Typical Xanbus System Diagram

Features

This section describes the different parts of the Freedom Sequence.

Ports and Terminals

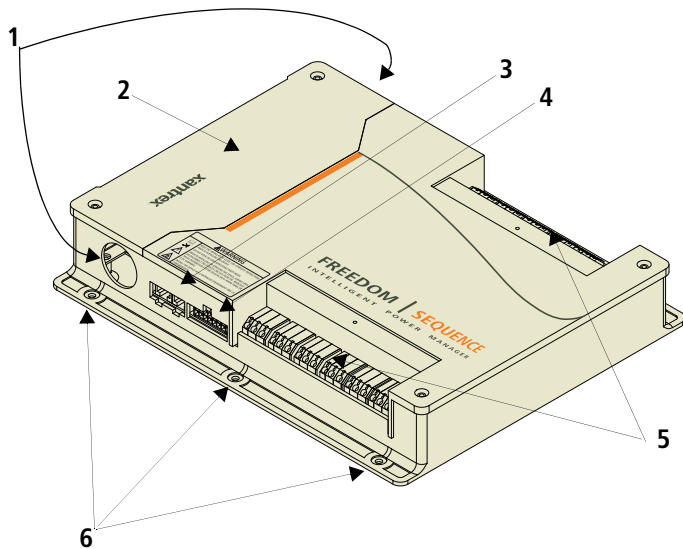

Figure 2 Freedom Sequence Ports and Terminals

Item	Description
1	AC Main section contains the current and voltage sensors to monitor the AC source and provides the pass-through wiring from a transfer switch to the vehicle's main distribution panel.
2	AC Main panel cover (removable for easy access)
3	Xanbus interface ports are used to connect Xanbus-enabled devices including the SCP, AGS and Freedom SW.
4	DC auxiliary connector port contains the terminals for four DC relays, Generator Run (B+) signal, and DC power.
5	AC relay three-wire terminal blocks provide six (or four) Cage Clamp® connectors for connecting AC load circuits. One load circuit corresponds to one AC relay. The relays are bidirectional meaning, there are no designated AC IN and AC OUT terminals.
6	Mounting holes are used for mounting the Freedom Sequence unit. There are six holes provided on the unit.

⚠ DANGER

ELECTRICAL SHOCK HAZARD
 Disconnect all DC and AC power before opening the AC Main panel.
Failure to follow these instructions will result in death or serious injury.

This guide for use by qualified installers only.

Features

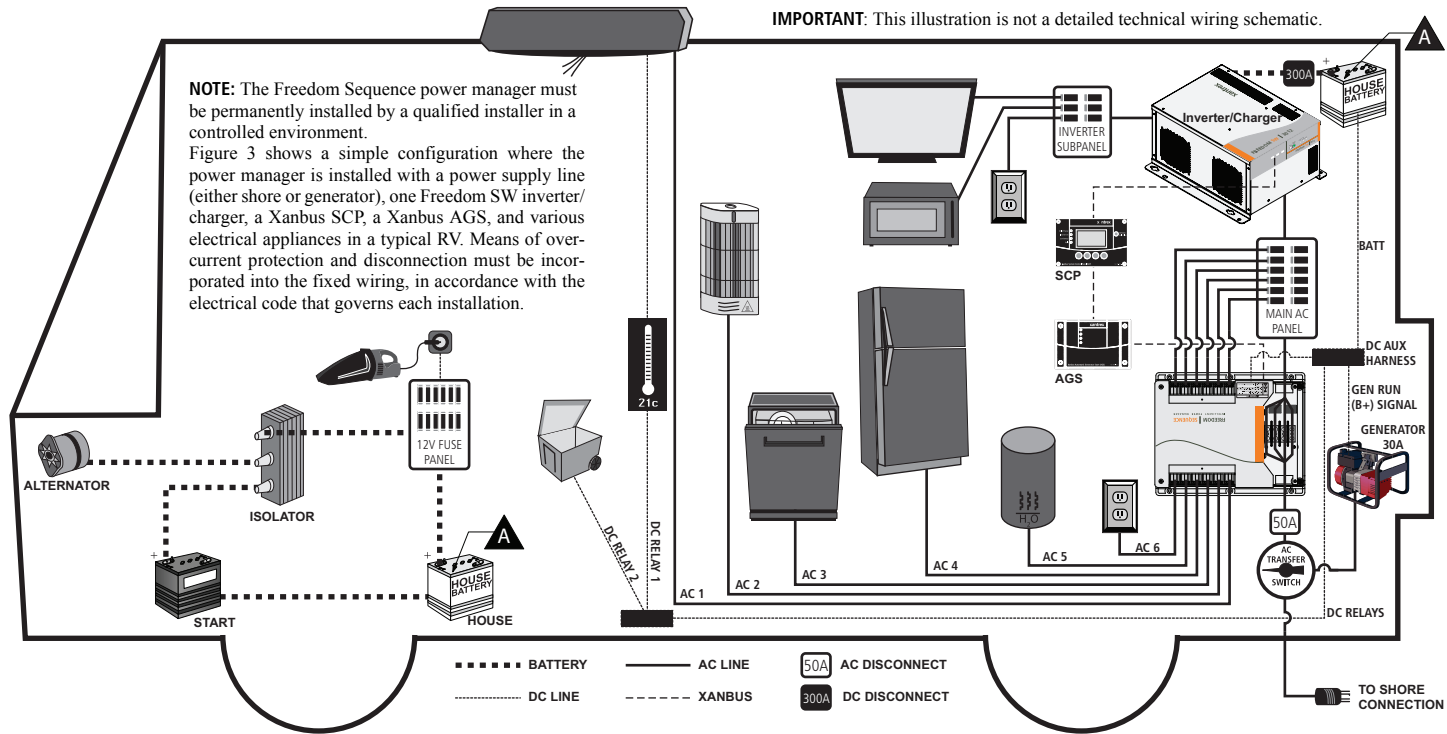

Figure 3 Typical RV Wiring Diagram With Freedom Sequence (six-circuit model shown)

Tools and Materials

Tools

3.5mm blade long neck screwdriver for opening the AC relay cage clamp connectors

Phillips screwdriver for removing and replacing the AC Main panel cover

power drill/screwdriver

drill bit set for drilling pilot holes

wire stripper

Materials

Qty

three-conductor plus bare ground AC Main cable – four-wire cable (see recommendations on page 9)	as needed
two-conductor plus bare ground AC Relay cable – three-wire cable (see recommendations on page 9)	as needed
wires to splice correspondingly with the wires on the supplied DC auxiliary connector wiring harness	as needed
AC Main cable one-inch metal strain relief	2
M5 Phillips pan head mounting screw or drywall anchor or plasterboard plug. Select the best mounting material suited to the type of surface.	6
M5 washers at 10mm OD max	6

Location

Install the power manager in a location that meets the following requirements:

Condition	Requirement
Dry	The power manager must be installed in a dry location not subject to moisture especially rain, spray, or splashing bilge water.
Clean	The power manager should not be exposed to metal filings or any other form of contamination.
Cool	The ambient air temperature should be between 0 – 50 °C (32 – 122 °F) for best performance.
Controlled Environment	By definition, a controlled environment is clean and can be provided by means of a totally closed, gasketed enclosure or the equivalent.

DANGER

EXPLOSION HAZARD

Do not place the power manager in machinery space or in areas containing gasoline tanks or fittings in which ignition-protected equipment is required.

Failure to follow these instructions will result in death or serious injury.

This guide for use by qualified installers only.

Features

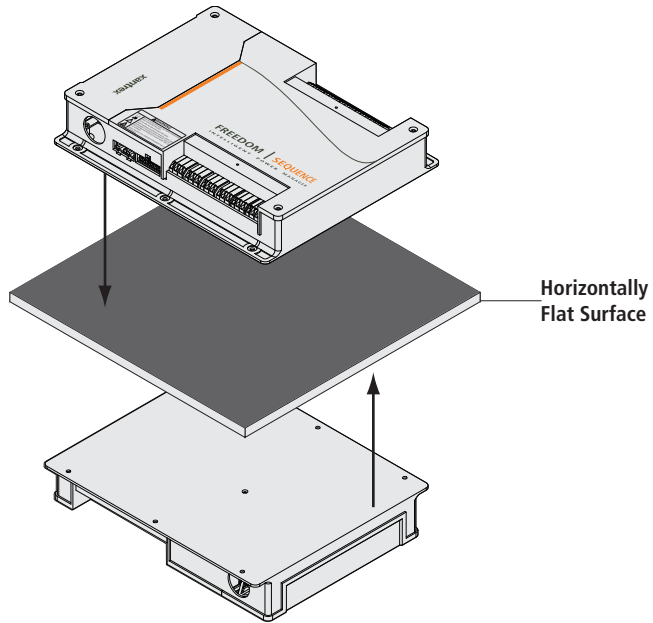

Figure 4 Mounting Orientations (Deck or Ceiling)

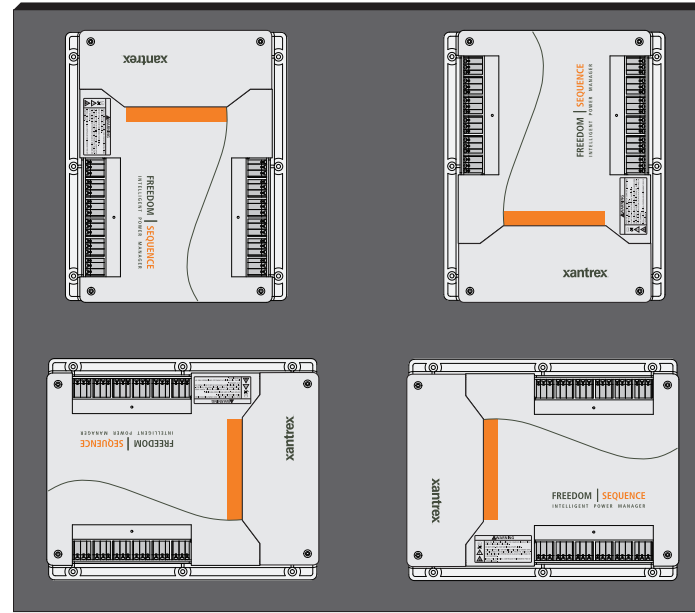

Figure 5 Mounting Orientations (Wall)

Wiring Requirements

DANGER

ELECTRICAL SHOCK AND FIRE HAZARD

Do not operate the power manager with damaged or substandard wiring. Make sure that all wiring is in good condition and is not undersized. A qualified installer must be used. See notes below.

Failure to follow these instructions will result in death or serious injury.

NOTES:

- Wiring and fuse sizes are governed by electrical codes and standards. Different requirements apply in different countries and to different types of installations, for example, boat, home or RV. It is the responsibility of the installer to ensure that each installation complies with all applicable codes and standards.
- Ensure that wires and fuses or breakered disconnects are correctly sized.
- According to the National Electrical Code, branch-circuit conductors shall have an ampacity not less than the maximum load to be served. *“Where a branch circuit supplies continuous loads or any combination of continuous and non-continuous loads, the minimum branch-circuit conductor size, before the application of any adjustment or correction factors, shall have an allowable ampacity not less than the non-continuous load plus 125% of the continuous load.”* However, an exception to this rule is permitted *“where the assembly, including the overcurrent protection device (OCPD) protecting the branch circuit is*

listed for operation at 100 percent of its rating, the ampere rating of the overcurrent device shall be permitted to be not less than the sum of the continuous load plus the noncontinuous load.” It is important to note that every appliance (also referred to as *“the assembly”*) is listed for operation at 100 percent of its rating as well as the circuit breaker (*“the OCPD”*). The additional current flowing into the appliances will cause additional heat. If the appliance or circuit breaker has not been listed for 100% application, temperatures may easily become excessive for the conductors and insulation.

In recognition of this exception, the Freedom Sequence allows you the option to disable the Breaker Derating by changing the default **Enabled to Disabled** in the Advanced Settings screen.

IMPORTANT: Appliances and circuit breakers that are 100% rated will have a listing on their product label similar to *“Suitable For Use On Single-Phase ~AC circuits. For 100% Application.”*

AC Breakers

Table 1 Recommended AC Breaker Sizes

	Type	Rating
AC Main circuit	toggle style AC circuit breaker	50 A (max)
Branch circuit	toggle style AC circuit breaker	15 A (max)

This guide for use by qualified installers only.

Features

AC Wiring

Table 2 Recommended AC Cabling and Wiring Sizes

	Type	AWG	Rating
AC Main	Romex® Copper SE Cable 3-conductor with bare ground	6 – 10 each wire	50 A
AC Relay/s	Romex® Copper Branch Circuit Cable 2-conductor with bare ground	12 each wire	15 A

DC Wiring

Table 3 Recommended DC Wiring Sizes

	Type	AWG	Rating
DC wire/s	stranded and color-matched with the wire/s on the DC auxiliary connector wiring harness (as shown)	18	5 A

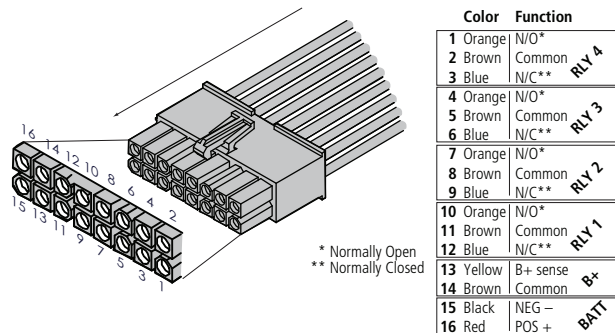

Installing the Freedom Sequence

Overview

Be sure to read the safety guidelines and pay attention to all cautions and warnings throughout the installation procedure. The installer is responsible for ensuring compliance with the installation codes for your particular application.

Installation Sequence

To make the installation quick and easy, Xantrex recommends that the installation tasks be performed in the following sequence:

1. Mount the Freedom Sequence.
2. Connect the AC Main wires.
3. Connect the AC Relay wires.
4. Connect the DC Relay wires.
5. Interconnect the Xanbus components.
6. Turn on the SCP and bring the Freedom Sequence to Safe Mode.
7. Configure Freedom Sequence via the SCP.
8. Turn on the RV power system.

Step 1: Mounting the Freedom Sequence

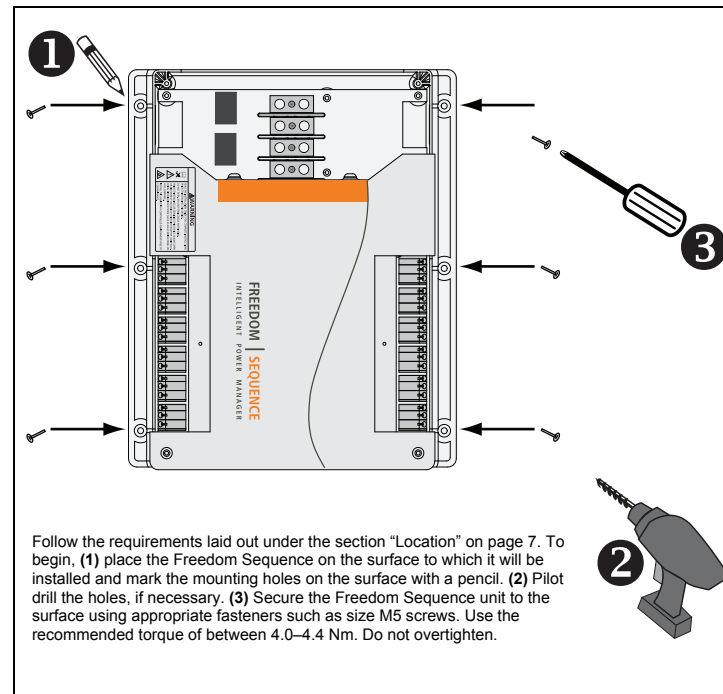

This guide for use by qualified installers only.

Installing the Freedom Sequence

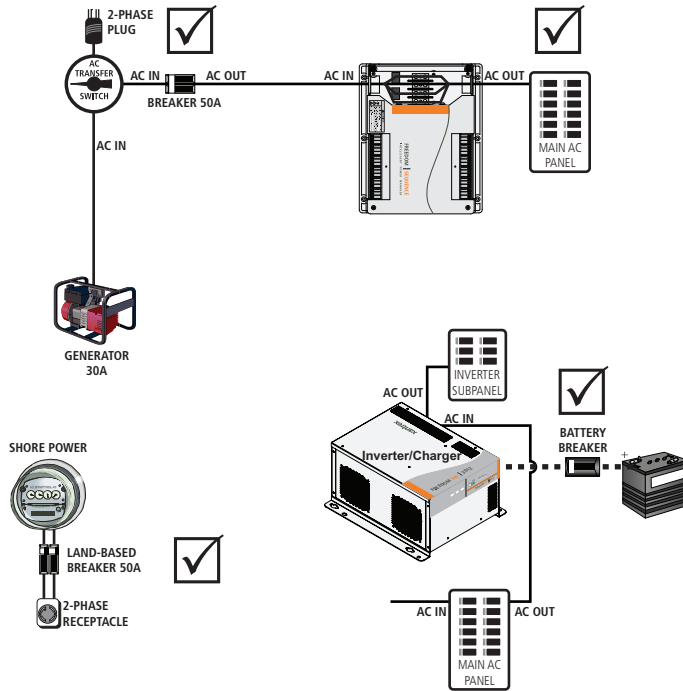

⚠ DANGER

ELECTRICAL SHOCK HAZARD

Turn off switches and open all disconnects including circuit panel breakers prior to wiring or servicing.

Failure to follow these instructions will result in death or serious injury.

⚠ WARNING

FIRE AND ELECTRICAL HAZARD

- Install in a controlled environment relatively free of contaminants.
- AC input wiring must be provided with a reliably grounded conductor.
- Compartments, raceways, and the like, for routing and stowage of conductors connected in the field shall not contain rough, sharp, or moving parts that may damage conductor insulation.
- Use only copper conductors, properly sized for the main 50-amp rated AC input branch circuit, and the 15-amp rated AC relay branch circuits.
- All AC relay circuits must have a common disconnect and be connected to the same pole of the disconnect (i.e. Main AC Panel).

Failure to follow these instructions can result in death or serious injury.

Figure 6 Switch and Disconnect Locations

Installing the Freedom Sequence

Step 2: Connecting the AC Main wires

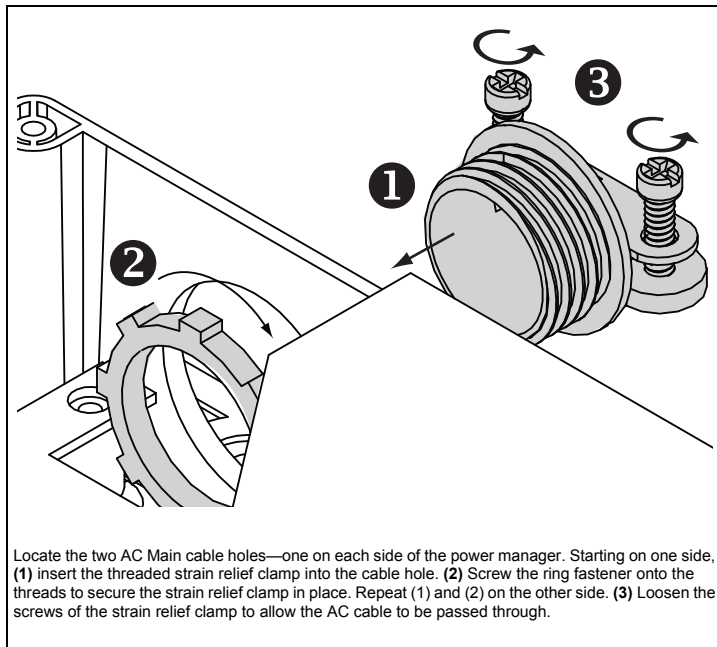

Figure 7 Install the AC Strain Relief Devices

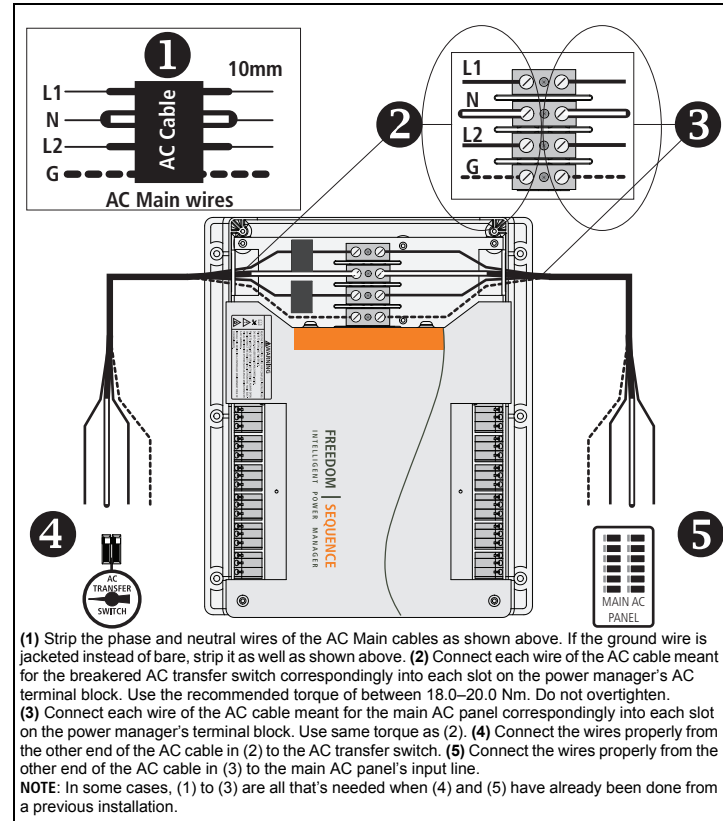
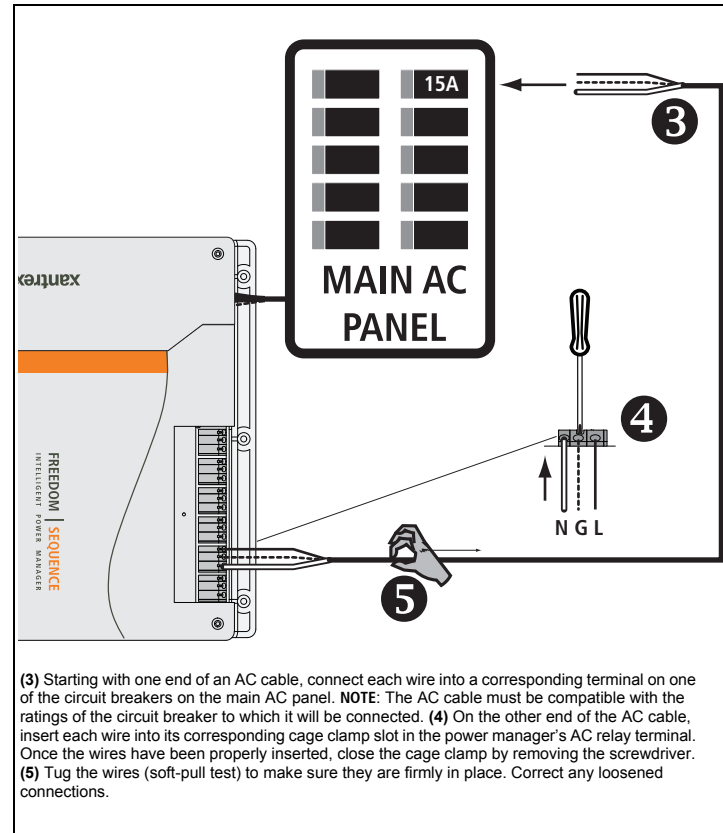
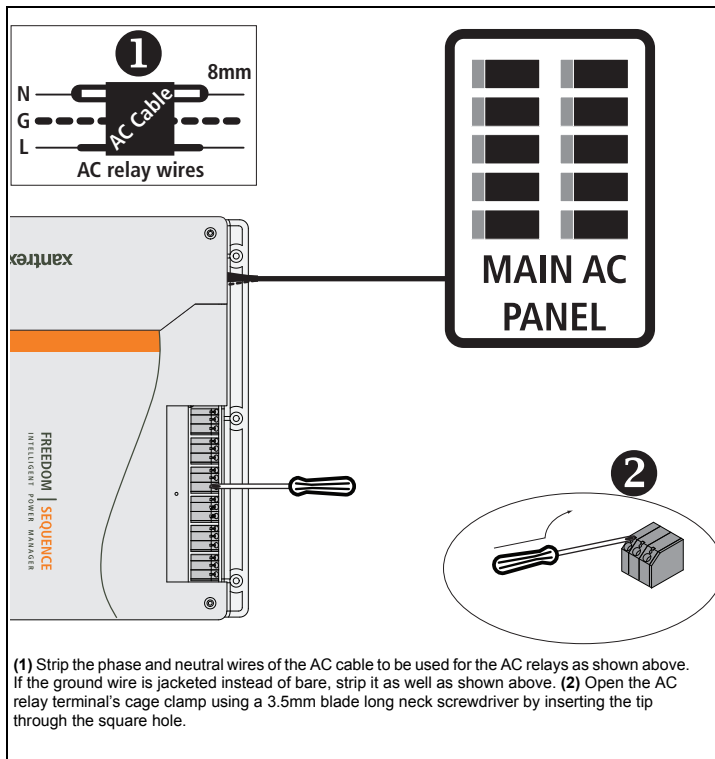

Figure 8 Connect the Input and Output AC Main Wires

This guide for use by qualified installers only.

Installing the Freedom Sequence

Step 3: Connecting the AC Relay Wires



Installing the Freedom Sequence

Step 4: Connecting the DC Relay wires

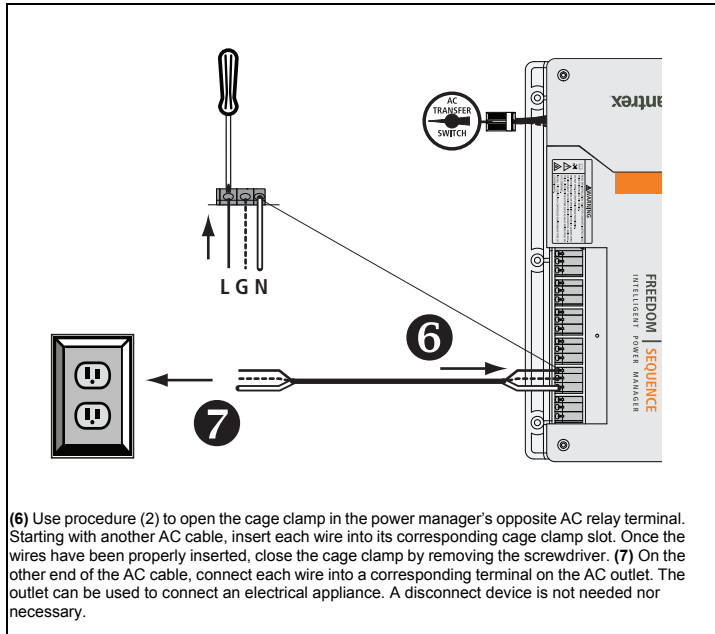

1 5mm
DC device wire/s

DC Device	N/O*	1 Orange	RLY 4
	Common	2 Brown	
	N/C**	3 Blue	
DC Device	N/O*	4 Orange	RLY 3
	Common	5 Brown	
	N/C**	6 Blue	
DC Device	N/O*	7 Orange	RLY 2
	Common	8 Brown	
	N/C**	9 Blue	
DC Device	N/O*	10 Orange	RLY 1
	Common	11 Brown	
	N/C**	12 Blue	

* Normally Open
** Normally Closed

NOTE: The color of the wires on each DC device may be different from the DC wiring harness' wire colors. It is important to match the functions of each wire and not rely on colors alone.

3 GENERATOR 30A
B+ sense 13 Yellow
Common 14 Brown
also known as Generator Run signal wire

4 BATTERY +12V
15 Black (-) BATT
16 Red (+) BATT

This guide for use by qualified installers only.

Installing the Freedom Sequence

Step 5: Interconnecting the Xanbus Components

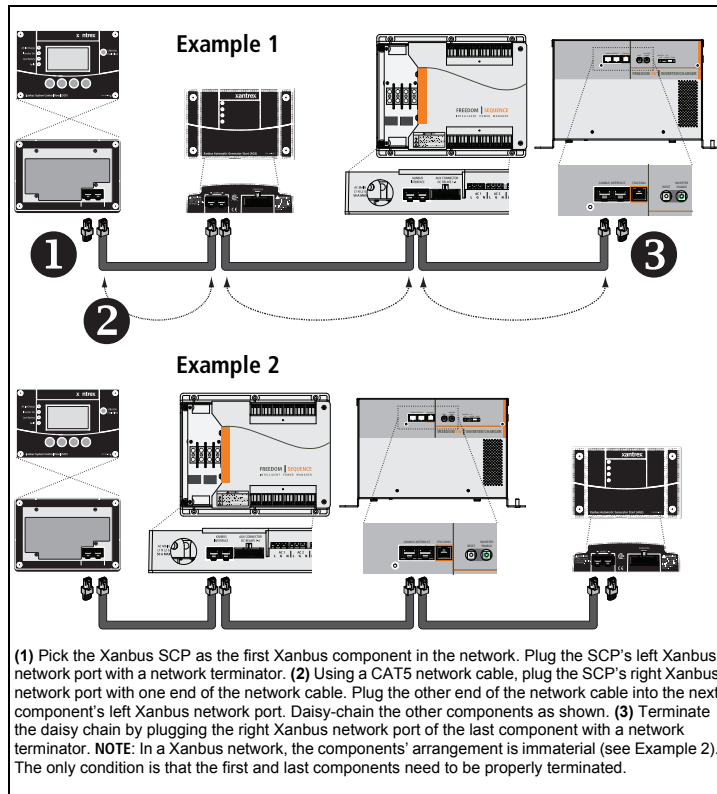

Step 6: Powering up the SCP

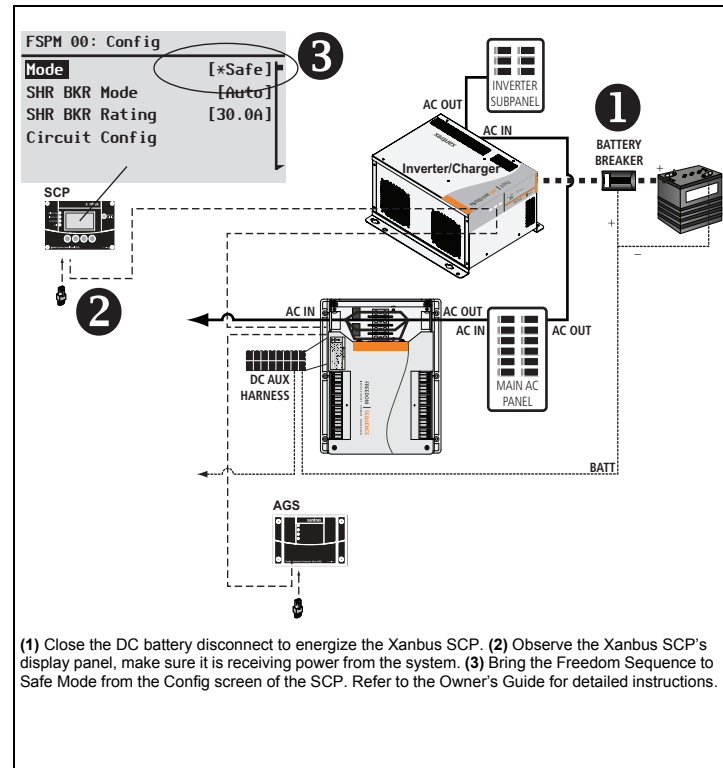

Installing the Freedom Sequence

Step 7: Configuring Freedom Sequence

Use the Freedom Sequence Owner's Guide to configure basic and advanced settings. To modify advanced settings on each circuit, refer to the Owner's Guide as well.

Step 8: Powering up the RV System

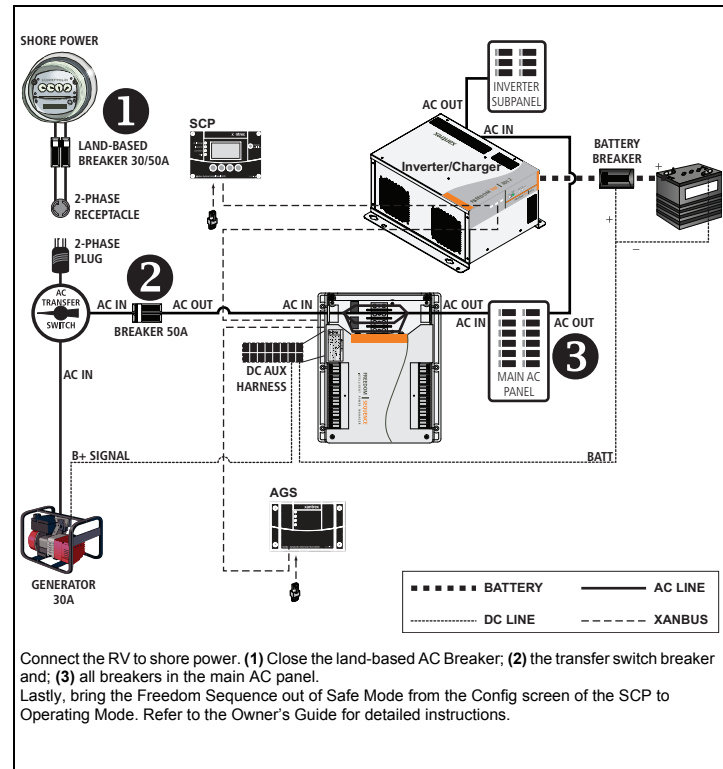

This guide for use by qualified installers only.

Freedom Sequence SCP Menu Map

Device Status Screen

FSPM 00: Status	
AC Src Type	1-Ph
AC Source	Shore1
L1 Amps	0.0A
L2 Amps	0.0A
Batt Voltage	12.0V
Circuit Status	
Config	
Advanced Settings	

NOTE: The Screens as shown in this Menu Map are typical of the six-circuit Freedom Sequence model.

For example, in the Circuit Status screen, a four-circuit Freedom Sequence model will show only eight circuits – four AC circuits and four DC circuits.

FSPM 00: Circuit Status	
1 ACLoad1	On 3.0A
1 Last Shed Current	6.0A
2 ACLoad2	On 4.5A
2 Last Shed Current	4.0A
3 ACLoad3	On 2.5A
3 Last Shed Current	2.5A
4 ACLoad4	On 2.3A
4 Last She Current	2.0A
5 ACLoad5	On 3.7A
5 Last Shed Current	1.0A
6 ACLoad6	On 3.0A
6 Last Shed Current	4.0A
7 DCLoad1	On N/A
7 Last Shed Current	N/A
8 DCLoad2	On N/A
8 Last Shed Current	N/A
9 DCLoad3	On N/A
9 Last She Current	N/A
10 DCLoad4	On N/A
10 Last Shed Current	N/A

FSPM 00: Config	
Mode	[Operating]
SHR BKR Mode	[Auto]
SHR BKR Rating	[30.0A]
Circuit Config	
Restore Defaults	

FSPM 00: Advanced Settings	
BKR Rating	[Enabled]
GEN BKR Rating	[30.0A]
GEN Warmup Delay	[0sec]
Connect Seq Delay	[10sec]
AC Disq Priority	[2]
Nom DC Voltage	[12.0V]
Circuit1	
Circuit2	
Circuit3	
Circuit4	
Circuit5	
Circuit6	
Circuit7	
Circuit8	
Circuit9	
Circuit10	

FSPM 00: Circuit Config	
1 ACLoad1	[1]
1 Priority	[Enabled]
2 ACLoad2	[2]
2 Priority	[Enabled]
3 ACLoad3	[3]
3 Priority	[Enabled]
4 ACLoad4	[4]
4 Priority	[Enabled]
5 ACLoad5	[5]
5 Priority	[Enabled]
Cont	

FSPM 00: Circuit Config	
6 ACLoad6	[6]
6 Priority	[Enabled]
7 DCLoad1	[7]
7 Load Shed	[Enabled]
8 DCLoad2	[8]
8 Priority	[Enabled]
9 DCLoad3	[9]
9 Priority	[Enabled]
10 DCLoad4	[10]
10 Load Shed	[Enabled]

FSPM 00: Circuit 1	
Circuit Name	[ACLoad1]
Load Shed	[Enabled]
Circuit Type	[ACInputOut]
AC Line	[Line1]
Priority	[2]
Reconnect MRGN	[10%]
GEN Soft Start	[Disable]
Batt Low Trig Set	[10.5V]
Batt Low Trig Cir	[11.0V]
Batt High Trig Cir	[14.0V]
Batt High Trig Set	[14.5V]

Settings

- 1 [Operating] or [Standby]
- 2 [Auto] or [Manual]
- 3 [30.0] [5.0] to [50.0]
- 4 [Enabled] or [Disabled]
- 5 [30.0] [5.0] to [50.0]
- 6 [40] [1] to [120]
- 7 [10] [4] to [60]
- 8 [1] [1] to [10]
- 9 [12.0V] or [24.0V]
- 10 [1] [1] to [10]
- 11 [Enabled] or [Disabled]

- A [*ACLoad1] see NOTE below
- B [*Enabled] or [Disabled]
- C [*ACInputOut] or [DCInputOut]
- D [*Line1] or [Line2] or [Batt1]
- E [1] [1] to [10]
- F [*10] [1] to [100]
- G [*Disable] or [Enable]
- H [*10.5] [4.0] to [40.0]
- I [*11.0] [4.0] to [40.0]
- J [*14.0] [4.0] to [40.0]
- K [*14.5] [4.0] to [40.0]

NOTE: Circuit names can be up to ten characters long. Valid characters are from a to z, A to Z, 0 to 9, symbols '/' (forward slash) and '-' (hyphen). Spaces, an underscore, and a period are not accepted symbols. Examples are "Main-A/C" and "Refrigerat".

Specifications

NOTE: Specifications are subject to change without prior notice.

Physical Specifications

Dimensions: L×W×H	254×355.6×63.5 mm (10×14×2.5 in.)
Weight	1 kg (2.2 lbs)
Xanbus ports	2
AC Main	1 set of split-phase pass-thru terminals (L1, N, L2, G) accessible by removing the AC Main panel cover
AC relay terminal blocks	6 pairs I/O terminal blocks - one pair for each AC relay (PN: 809-0912) 4 pairs I/O terminal blocks - one pair for each AC relay (PN: 809-0913)
DC auxiliary connector port	4 (3-pin connector for each DC relay) 1 (2-pin connector for one Generator Run signal) 1 (2-pin connector for battery)

Environmental Specifications

Operating range	-20 to 50 °C (-4 to 122 °F)
------------------------	-----------------------------

Electrical Specifications

AC Main input voltage	120/240 VAC single/split phase
AC Main input current	Split phase: 50 AAC per phase Dual in phase: 30 AAC per phase
DC input voltage from battery source	12/24 VDC
AC relay input voltage	120 VAC
AC relay input current	15 AAC per circuit
DC relays input voltage	12/24 VDC
DC relays input current	5 ADC per circuit

Regulatory Approvals

Safety	UL 916, CSA C22.2 No. 205
EMC	FCC Part 15, Class B

This guide for use by qualified installers only.





Xantrex Technology USA Inc.

1 800 670 0707 Tel

1 800 994 7828 Fax

www.xantrex.com

975-0594-01-01

Printed in China.